

GASTRONOMIE- UND SERVIERARTIKEL

FOOD SERVICE EQUIPMENT

EQUIPAMIENTOS PROFESIONALES

EQUIPEMENT PROFESSIONNEL



2016
SINCE 1933

Herzlich Willkommen bei APS

Auch in diesem Jahr freuen wir uns, Ihnen wieder eines der übersichtlichsten Nachschlagewerke in der Welt der Gastronomie- und Servierartikel präsentieren zu dürfen. Auf rund 470 Seiten haben wir über 3.000 Artikel übersichtlich in 11 Kategorien zusammengefasst.

Welcome to APS

We are happy to present you one of the most well arranged reference book in the world of food service equipment. On round about 470 pages we clearly show you more than 3.000 items pooled in 11 categories.

Bienvenido a APS

Nos complace presentarle uno de los catálogos mejor elaborados en el mundo de equipamiento profesional. A través de unas 470 páginas le mostramos una selección de más de 3.000 artículos distribuidos en unas 11 categorías.

Bienvenue chez APS

Nous avons le plaisir de vous présenter un catalogue CHR parmi les plus complets et professionnels du secteur de la restauration hors-foyer et de l'hôtellerie en ce qui concerne le petit équipement et les ustensiles pour la cuisine et pour le service. Découvrez quelques 470 pages qui regroupent plus de 3.000 articles répartis dans 11 familles de produits.



Assheuer + Pott GmbH & Co. KG
Talweg 11, 59846 Sundern, Germany

Telefon +49 (0) 29 33 / 97 35-0
Fax (Zentrale) +49 (0) 29 33 / 97 35-35
Fax (Export) +49 (0) 29 33 / 97 35-34
info@aps-germany.de
www.aps-germany.de

Reinhold Pott
- general manager -

Johannes Becker
- general manager -



Familiengeführtes Unternehmen in 4. Generation
family-run company in 4th generation



APS Assheuer + Pott GmbH & Co. KG



Standort Sundern/Sauerland in der Mitte Deutschlands
headquarters in Sundern in the heart of Germany



Kundengespräch Messe Köln 1958
customer meeting trade fair Cologne 1958

SINCE 1933



Made in Germany

Tablett
tray
bandeja
plateau
11100

Edelstahlproduktion in Deutschland
production of stainless steel items in Germany



Aus einer Hand: Vom Designkonzept bis zur Auslieferung
design > prototype > manufacture > supply

Seite/page

15 APS+



20



25



27



28



33

35

Servierartikel aus Melamin
serving items melamine
artículos de servicio en melamina
pièces de service en mélamine



42



43



53



60



108

111

Servierartikel
serving items
artículos de servicio
pièces de service



114



136



147



149



156

163

Buffet . Banquet
buffet . banquet
buffet . catering
buffet . catering



181



210



226



176



166

243

Chafing Dish
chafing dish
chafing dis
chafing-dish



244



265



260



262



266

267

GN . GN-Zubehör
GN . GN-extras
GN . GN-extras
bacs et accessoires GN



276



282



278



280



284

289

Bar . Wein
bar . wine
bar . vino
bar . vin



290



294



330



331



339

343

Kaffee . Körbe
coffee . basket
café . cestas
café . corbeilles



361



385



389



390



393

399

Kochen . Backen
cooking . baking
cocinero . repostería
cuisinier . pâtisserie



403



408



411

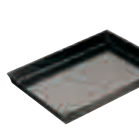

401



420

421

Werkzeug
kitchentool
cocinas herramientas
cuisines l'outil



442



452



453



442



452

455

Zubehör . Hauben
spare parts . covers
recambios . tapas
pièces de rechange . cloches



456



457



462



461



462

NEUHEITEN

NEWS

NOVEDAD

NOUVEAUTÉS

2016



APS+ - Seite/page 24



Fullies - Seite/page 42



Tablets / trays „OAK LIGHT“ - Seite/page 36



Buffetkorb / buffet basket - Seite/page 360-363



Tablets / trays „SLATE“ - Seite/page 43



LA VIDA - Seite/page 49



Tablett / tray „CROCO“ - Seite/page 156



Buffet-Leiter / buffet ladder - Seite/page 186



Snack Holder - Seite/page 114



Schalen / bowls „AIKO“ - Seite/page 50



Sektkühler / champagne bowl - Seite/page 294

Icon-Index / Material-Index



neuer Artikel
new item



spülmaschinenfest
dishwasher-proof



für Induktionsplatten
for induction use



Niedriger-Preis
hot price



nicht spülmaschinenfest
not dishwasher-proof



kühlbar
for cooling



made in Germany



doppelwandig
double wall



bruchsicher
shatter-proof



1-a-Profiquität
prime quality



mikrowelleneeignet
microwave-proof



stapelbar
stackable



APS-Design



nicht mikrowelleneeignet
not microwave-proof



abwaschbar / wasserfest
water-proof



GN-Größen
GN norm



keine direkte Hitze
not direct heat



Eigenmontage
self assembly



für Lebensmittelkontakt
food safe



nicht für Backofen
not for bakin oven

APS - BSCI-Mitglied

APS engagiert sich für die Verbesserung von Arbeitsbedingungen. Wir sind Partner der europäischen Organisation BSCI. Die "Business Social Compliance Initiative" (BSCI) ist eine Initiative von Unternehmen zur Verbesserung der Arbeitsbedingungen in der globalen Versorgungskette.

APS is a member of BSCI

APS is committed to the improvement of working conditions. APS is a partner of the European organization BSCI. BSCI "Business Social Compliance Initiative" is an initiative of enterprises to improve working conditions in the global supply chain.



APS Melamin - Garantierte Qualität

APS Melaminprodukte entsprechen der Richtlinie EG1935/2004 und 10/2011 der Europäischen Kommission. Diese enthält Bestimmungen für Materialien aus Kunststoff, welche mit Lebensmitteln in Berührung kommen. Wir arbeiten sehr eng mit den Zertifizierungsinstitutionen Intertek und TÜV zusammen und können somit die Lebensmittelechtheit (LFGB Regulation) der APS Melaminartikel garantieren.

APS Melamine - Guaranteed quality

APS melamine products comply with directive EG1935/2004 und 10/2011 of the European Commission. This contains provisions for plastic materials which come into contact with foodstuffs. We work very closely together with the certification institutions Intertek and TÜV, and are therefore able to guarantee the compatibility with foodstuffs (German LFGB regulation) of APS melamine articles.

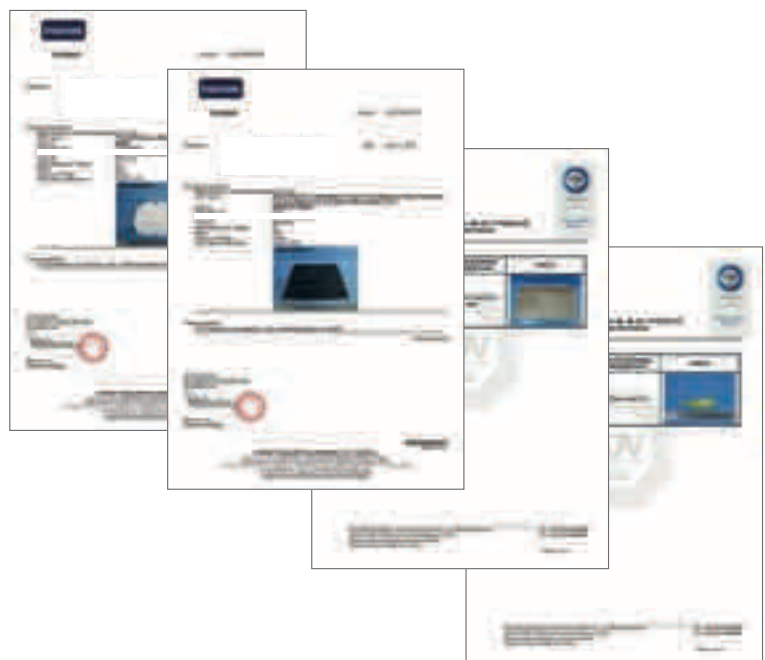

**Edelstahl 18/10 / Stainless steel 18/10**

Werkstoff 1.430 rostfrei; langlebig; schlechter Wärmeleiter, daher gute isolierende Eigenschaften; absolut hygienisch und nicht toxisch; recyclebar; nicht resistent gegen dauerhaften Kontakt mit Chloriden und Säuren (z.B. Kochsalz und Fruchtsäuren); sterilisierbar; Oberfläche lässt sich vielfältig polieren; nicht magnetisch; ab 400°C Verfärbungen
 Pflege: pflegeleicht; maschinell oder per Hand mit milden Spülmitteln; möglichst keine Stahlwolle u.ä. verwenden; nach Erhitzung Schockabkühlung vermeiden

**Edelstahl (unspezif.) / Stainless steel (unspecific)**

niedrig nickelhaltige Edelstähle wie 14/4, nicht magnetisch, geringere allgemeine Resistenz als Edelstahl 18/10
 Pflege: siehe Edelstahl 18/10

**Edelstahl 18/0 / Stainless steel 18/0**

Werkstoff 1.4016 rostfrei und langlebig bei entsprechender Pflege: absolut hygienisch und nicht toxisch; gut härtbar, daher idealer Stahl für Tafelmesser, Tablettts, Schneidwerkzeuge u.ä.; lässt sich hoch Glanzpolieren; für Nickel-Allergiker geeignet; magnetisch; hitzeresistent wie Edelstahl 18/10; nicht so chemikalienresistent wie Edelstahl 18/10
 Pflege: maschinell oder per Hand mit milden Spülmitteln; Ablagerung von Kalk und Reinigerresten nach dem Spülen unbedingt entfernen; niemals mit Stahlwolle reinigen

**Eisen / Iron**

nicht rostfrei; charakteristische strukturierte Oberfläche mit unterschiedlichen Schattierungen; durch wiederholten Schmiedevorgang ist das Material stark verdichtet und sehr hart; langlebig bei entsprechender Pflege
 Pflege: vor Kocheinsatz mit Öl und Kartoffelschalen „einbraten“, später nach jeder Reinigung immer einfetten; trocken lagern

**Gusseisen / Cast Iron**

langlebig bei entsprechender Pflege; geeignet für alle Herdarten (incl. Induktion); speichert lange Wärme und gibt sie gleichmäßig ab; absolut hygienisch bei unbeschädigter Oberfläche; relativ schweres Material; Überhitzung fast nicht möglich; nicht schlagfest; magnetisch
 Pflege: nach Gebrauch sofort mit heißem Wasser füllen; bei Fleckenbildung mit Essig nachreinigen; niemals mit Stahlwolle reinigen; milde Spülmittel verwenden

**Versilberter Stahl / Silver plated steel**

Edelmetall; nicht völlig säurefest; nicht längere Zeit Sonnenlicht aussetzen
 Pflege: niemals scheuernde Hilfsmittel verwenden; nur mit weichen Lappen und Spezialmitteln reinigen, keine Spülmaschinenreinigung!

**Verchromter Stahl / Chrome plated steel**

nichtedeles Metall mit hartem Chromüberzug; nicht säurefest, nach Beschädigung der Chromschicht kein Schutz gegen Umwelteinflüsse
 Pflege: niemals scheuernde Hilfsmittel verwenden; nur mit weichen Lappen

**Aluminium**

sehr leichtes Material, sehr gute elektrische und thermische Leitfähigkeit, korrosionsbeständig

**Porzellan**

hitzebeständig bis 220°C

**ABS - Styrolacrylbutadiennitril**

sehr gute Oberflächenhärte, temperaturwechselfest, spülmaschinenfest
 Hitzeresistenz bis ca. +120°C

**SAN - Styrolacrylnitril**

ABS ohne Butadien, daher nur gute Oberflächenhärte, temperaturwechselfest, spülmaschinenfest
 Hitzeresistenz bis ca. +120°C

**PP - Polypropylen**

hart elastisch; unzerbrechlich; formbeständig in kochendem Wasser; sterilisierbar; umweltschonend recyclebar, spülmaschinenfest, Mikrowellen geeignet,
 Hitzeresistenz -30°C bis ca. +75°C

**PE - Hochdichtes-Polyethylen**

hart elastisch; unzerbrechlich; in heißem Wasser ausreichend formbeständig; glänzend
 Hitzeresistenz -40°C bis ca. +120°C
 NPE - Niederdichtes-Polyethylen
 weich elastisch; unzerbrechlich; in heißem Wasser kurzzeitig formbeständig; nicht glänzend
 Hitzeresistenz -40°C bis ca. +95°C

**ACRYL - Künstliches Harz**

farblos; glasartig durchsichtig; nicht splitternd; chemisch modifiziert als Plexiglas®; Wichtiger Pflegehinweis; nur handelsübliche Acrylspazialreiniger oder milde alkohol- und ammoniakfreie Reinigungsmittel verwenden.
 Nicht spülmaschinenfest
 Hitzeresistenz -40°C bis ca. +50°C

**PS - Polystyrol**

starr; schlag- und kratzfest; in kochendem Wasser formbeständig; sterilisierbar
 Hitzeresistenz bis ca. +75°C

**PA - Polyamid**

starr; bruch- und schlagfest; mattglänzend
 Hitzeresistenz bis ca. +220°C

**MF - Melamin**

sehr hart; kratzfest; sterilisierbar; hygienisch; stoßfest und beständig gegen Säure
 Hitzeresistenz ca. -30 °C bis +70°C

**PC - Polycarbonat**

starr; nahezu unzerbrechlich; sehr stabil; in kochendem Wasser formbeständig; sterilisierbar; spülmaschinenfest, Mikrowellen geeignet,
 Hitzeresistenz -30°C bis ca. +100°C

**PVC - Kunststoff**

ist beständig gegen Säuren, schwer entflammbar,
 Hitzeresistenz -50°C bis ca. +60°C

**MS - Kunststoff**

farblos, glasartig, durchsichtig, nicht spülmaschinengeeignet
 Hitzeresistenz 0 bis ca. +70°C

**Silicon**

hohe thermische Beständigkeit, gute Kälteflexibilität
 Hitzeresistenz ca. -70°C bis +180°C

Laserlogo Individual

perfekte Lasergravuren
perfectly Laser engravings
Perfecto grabado por láser
Perfeito Laser gravura



Unverwechselbar - Einzigartig - Imagefördernd
Ihre individuelle Lasergravur von APS

Wir bieten Ihnen die Möglichkeit, unsere Produkte mit Ihrem individuellen Logo per Laser zu gravieren - einzigartig, unverwechselbar und bereits ab 10 Stück je Artikel. Die perfekte Beschriftung durch modernste Lasertechnologie ist spülmaschinenfest und somit dauerhaft auf allen Edelstahl- und Naturschieferprodukten, sowie auf versilberten und verchromten Metall-Artikeln umsetzbar. Machen Sie aus Ihren Gastronom-Behältern Ihre ganz persönlichen Unikate und werten Sie Ihre Servierartikel mit Ihrem eigenen Logo auf.

- **geringe Mindestbestellmenge von nur 10 Stück**
- **kurze Lieferzeiten**
- **Logos bis zu einer Fläche von max. 10 x 10 cm realisierbar**

Distinct - Unique - Image enhancing
Your individualised laser engraving by APS

We offer you the option of having your personalised logo engraved on our products - inimitable, unique, and available for delivery from only 10 pieces per product. The perfect inscription by use of the newest technology is dishwasher-safe and thus can be permanently applied to products made of stainless steel and natural slate, as well as silver-coated and chromed metal articles. Turn your gastronorm container into your individual, one of a kind article and enhance your serving items with your own logo.

- **minimum order quantity of only 10 pieces**
- **swift delivery**
- **feasible logos are those with a maximum size of 10 x 10 cm**

Único, personalizado, promotor de imagen
Grabado laser por APS

Podemos grabar su logo y así personalizar los productos APS a partir de mínimo 10 unidades por referencia.

Gracias a la novedosa tecnología de grabado por láser, la inscripción es perfecta y resistente al lavavajillas. Se puede aplicar a los artículos en acero inoxidable, pizarra natural, metal cromado y plateado.

- **Cantidad mínima de solamente 10 unidades**
- **Realización rápida**
- **Tamaño de logos hasta máximo 10 x 10 cm**

Unique, original, porteur d'image
Marcage laser par APS

Nous pouvons graver votre logo et ainsi personnaliser les produits APS à partir de 10 pièces par référence.

Grâce à une technologie d'avant-garde de marçage par laser, l'inscription est parfaitement reproduite et résistante au lave-vaisselle. Ce type de marçage peut s'appliquer sur l'acier inoxydable, sur l'ardoise naturelle, sur le métal chromé ou argenté.

- **Quantité minimum de seulement 10 unités**
- **Fabrication rapide**
- **Taille du logo jusque 10 x 10 cm**

DEUTSCH

Artikel Seite

| | |
|--------------------------------|---|
| A | |
| Abdeckhauben | 25, 27, 134, 203-215 456-460 |
| Abfallbehälter | 328, 394-398 |
| Abräumwagen | 284, 285 |
| Abtropfmatte/Bar-Matte | 318 |
| Adapter/Zwischensteg | 271 |
| Allzweckgießer | 378, 379 |
| Ananasschneider | 314 |
| Apfelentkerner, -schäler | 426, 427 |
| Aschenbecher/Standascher | 325-328 |
| Aufstrichmesser | 434 |
| Ausgießer | 318 - 320 |
| Auslageschalen | 73 |
| Ausstellblech | 416 |
| Ausstecher | 422, 423 |
| Austernöffner/-messer | 427 |
| B | |
| Bäckerpaletten | 431-433 |
| Backblech/-form | 401, 415, 416 |
| Backhandschuhe | 411 |
| Baquettekörbe | 347, 354 |
| Bain-Marie-Einsatz | 259 |
| Bar-Caddy/Löffel/Set/Sieb | 308, 311 |
| Barmaße | 310 |
| Barmatte | 318 |
| Becher Melamin | 102 |
| Beilagenschale | 115, 116, 143 |
| Behälter/Schale Melamin | 45, 47, 51, 53, 55, 59, 61, 65-68 71, 73-80, 84-86 89-91 |
| Beschriftungsfähnchen | 331, 334 |
| Besteck-Ablage/Ständer/Körbe | 167 174, 197 278-280 |
| Besteckköcher | 278 |
| Bestecksammler/Behälter/Kasten | 167 174, 197 273, 278-280 |
| Bialetti Moka-Express | 388 |
| Bierglasträger | 317 |
| Blattschale | 27, 90-91 |
| Blumenvasen | 336 |
| Bonspieß/-leiste | 413 |
| Boston-Shaker | 308, 309 |
| Bratenplatte | 135, 137, 145 |
| Brennpastenbehälter | 261 |
| Brezel-/Wurstständer | 185 |
| Brötchen-Spender | 221, 223, 346 |
| Brotkorb | 348-353, 356 357, 360-363 |
| Brotscneidebrett | 170, 221, 222 |
| Brotstation | 221, 223, 346 |
| Brottasche Baumwolle | 360 |
| Buffet-Brett Holz | 112-113, 136, 144 |
| Buffet-Gestell | 80, 87-88, 186-187 219, 220 |
| Buffet-Gestell für Körbe | 178, 186-189 359 |
| Buffet-Leiter | 186-189 |
| Buffet-Pyramide | 238-242 |
| Buffet-Set | 168-173, 221 206-215 |
| Buffet-Ständer | 29, 33, 110 145, 176, 177 |
| Buffet-Vitrine | 170, 205, 207-214 |
| Butterdose Kühlschrank | 150 |
| Butterroller | 425 |
| Butterservierer | 150 |
| C | |
| Canapee-Gabeln | 104-105, 161, 242 |
| Cerealien-Karaffe | 193, 194 |
| Cerealienspender-Bar | 166, 193-196 |

| | |
|------------------------------------|--------------------------------|
| Chafing-Dish | 244-258 |
| Chafing-Dish Suppen-Kugel Globe | 247 |
| Chafing-Dish Suppentopf/-station | 247 253, 258, 259 |
| Champagnerkühler | 294-297 |
| Champagnerverschluss | 319, 320 |
| Clips für Beschriftungsschilder | 330 |
| Cloche | 25, 123 |
| Cocktail-Doppelmaß | 310 |
| Cocktailmesser | 307, 429 |
| D | |
| Darioform | 407 |
| Deckel Bain-Marie | 259 |
| Deckel SAN | 72, 79, 85 |
| Deko Früchte | 179 |
| Dekoriermesser | 426, 428 |
| Dip-Schälchen Melamin | 19, 21, 92 |
| Dispenser Iso | 228 |
| Dispenser Kaffee | 228, 251 |
| Dispenser Saft/Milch | 229-237 |
| Dose Vorrat | 412 |
| Dosier-/Vorratsflasche | 316, 410 |
| Dosier-/Vorratsflasche Verschluss | 317 |
| Dosierer Spirituosen | 318-320 |
| Dosierer Zucker | 378, 379 |
| Dosierspender | 316 |
| Drehplatte | 119, 241 |
| Dressingtopf | 106, 161, 162 |
| E | |
| Eierbecher | 151 |
| Eier-Box/Korb | 151 |
| Eierschneider | 151 |
| Eisbox / Eiseimer | 303-305 |
| Eis-Kugel/Würfel-Former | 306 |
| Eisportionierer | 443 |
| Eisschaufel | 312, 452 |
| Eiswaffelständer | 420 |
| Eiswürfelbehälter | 303-305 |
| Eiszange | 310 |
| Eiszerkleinerer | 306 |
| Entkerner Apfel/Zucchini | 427 |
| Entstieler | 426, 427 |
| Essig- / Öl-Gläser / Menagen | 371-375 |
| Etagere | 179-184 |
| F | |
| Fadenschneider | 424 |
| Fassbock | 323 |
| Fast-Food Tablett | 155 |
| Feuerzange | 264 |
| Feuerzangenbowle | 264 |
| Fettabstecher | 432, 434 |
| Fingerfood-Löffel/-Teller | 27, 57, 60, 61 97, 104, 105 |
| Fischentschupper/-zange | 430 |
| Fischplatte / Fischschale | 94, 95, 144 |
| Flaschenausgießer | 318-320 |
| Flaschenhalter Wein | 324 |
| Flaschenhalterung mit Portionierer | 318 |
| Flaschenkühler | 290-292, 294-303 |
| Flaschenöffner | 312, 313 |
| Flaschenträger | 317 |
| Flaschenverschluss | 320-322 |
| Fleisch-/Gemüseplatte Edelstahl | 135 |
| Fleischgabel/Tranchiergabel | 286, 287 436, 440 446 |
| Folien-Abreibvorrichtung | 420 |
| Fondantrichter | 409 |
| Frames | 168-174 |
| Frischhaltehauben | 456-460 |
| Fritierlöffel | 402 |
| Fritier- und Servierkorb | 114, 115 |
| Fruchtsaftpressen | 315 |
| G | |
| Gabel Pellkartoffel | 426 |
| Garnierschneider Dreieck | 427 |
| Gebäckzangen | 445, 450 |

| | |
|-------------------------------------|---|
| Gemüsemesser | 429 |
| Gewürzkasten | 411 |
| Gewürzstreuer | 381, 383 |
| Glas-/Spiegelplatte | 122 |
| Gläserhalter/-schiene | 317 |
| Gläsertransportkiste | 280 |
| Glasumrander | 305 |
| Glocke/Cloche | 25, 123 |
| GN Behälter/ Deckel Polypropylen | 275 |
| GN-Abtropfgitter Polycarbonat | 274 |
| GN-Behälter/ Deckel Edelstahl | 268-272 |
| GN-Behälter Edelstahl mit Fallgriff | 271 |
| GN-Behälter Edelstahl perforiert | 270 |
| GN-Behälter/ Deckel Polycarbonat | 274 |
| GN-Behälter Melamin | 276, 277 |
| GN-Behälter Porzellan | 276 |
| GN-Deckel Polyethylen luftdicht | 272 |
| GN-Konvektomatenblech | 272 |
| GN-Roste | 273 |
| GN-Steckdeckel | 271 |
| GN-Tablett | |
| - Edelstahl | |
| - Melamin | |
| - Schiefer | |
| - Spiegelplatte | 30, 31, 37, 40, 41 45-49, 63, 69, 70 73, 77, 79, 82-85 122, 128-136, 137-140 |
| Gourmet-Display | 238-242 |
| Gourmetlöffel | 242 |
| Grapefruitmesser | 428 |
| Grillzange | 449 |
| Grissini-Halter | 362 |
| H | |
| Hammer Holz | 323 |
| Haube | 25, 29, 113, 134, 148 170, 171, 191, 203 205 - 215, 220, 456-460 |
| Heizelement Elektro | 245, 251, 262 263 |
| Heizung Mobil für Chafing Dish | 263 |
| High Tea Rack | 175 |
| Hobel | 185, 409, 430 |
| Hot Plate | 263 |
| Hüllen für Speisekarten | 332 |
| Hygieneschutz | 222, 223 |
| I | |
| Induktionskochplatte | 262, 263 |
| Iso-Dispenser | 228 |
| J | |
| Jigger | 310 |
| Julienschneider | 429 |
| K | |
| Kaffeebecher | 102 |
| Kaffeedispenser | 251 |
| Kaffeekanne | 388 |
| Kännchen für Olivenöl | 405 |
| Kanne/Karaffe Saft-/Wasser-/Milch | 225-227, 302 |
| Kartenhalter | 332, 333 |
| Kartoffelstampfer | 442 |
| Käseglocke/Set | 206, 207 |
| Käsemesser, Käsehobel | 429, 430 |
| Kaviarkühler | 160 |
| Kelle Suppe | 436, 438, 439, 447 |
| Kerzenleuchter, Windlichter | 337-342 |
| Konditorplatte | 146, 147, 417-419 |
| Konfitürenbehälter | 216, 217 |
| Konservator Champagner-/Sekt | 320 |
| Korb Edelstahl | 362, 363 |
| Korb Metall verchromt | 360, 363 |
| Korb Polypropylen | 344-359 |
| Korkenzieher | 312, 313 |
| Kronkorkenöffner/-Sammelbehälter | 312, 313 |
| Kuchen-/Quiche-Form | 415 |
| Kuchenblech | 416 |

| | |
|--|--|
| Kuchenheber | 432, 448 |
| Küchentuchständer | 412 |
| Kugelausstecher | 422, 423 |
| Kühlakku | 462 |
| Kühlbox/-tablett | 191, 203, 208, 210 |
| Kühler Champagner | 294-297 |
| Kühler Flaschen | 290-292, 294-303 |
| Kühler Konferenz | 298 |
| Kühler Wein/Sekt | 295-297 |
| Kühlmanschette | 303 |
| Kühlschale | 160, 161, 165, 172, 173 216-218 |
| L | |
| Likör-/Fondantrichter | 409 |
| Limettenpresse | 314 |
| Löffel Feinkost/Salat/Dressing | 106, 107 |
| M | |
| Mehlschaufel | 452 |
| Melamin-Schale | 19-27, 42-103 |
| Melamin-Tablett | 25, 30, 31, 36-52 57-63, 67-70, 73 77, 79, 82-85 |
| Menage | 371-377 |
| Messbecher | 385, 405 |
| Messer Cocktail | 429 |
| Messerabstreichbehälter | 420 |
| Messerbänkchen | 389 |
| Messerhalter Magnet | 413 |
| Messkanne | 385, 405 |
| Messlöffelsatz | 444 |
| Metallrahmen für Induktionsplatte | 263 |
| Milch Dispenser / Milch Kanne | 234 235, 385 |
| Milchgießer/-kännchen | 378, 379, 386 |
| Milch-Zucker Set | 386 |
| Mühlen | 381, 382 |
| Müllbeutelreimer | 328 |
| Multi-Rack | 175-177 |
| Muschelschale/-topf | 160 |
| Müslispender | 193-196 |
| N | |
| Nestbacklöffel/-schaufel | 402 |
| Nudelmaschine | 409 |
| O | |
| Ölkanne | 405 |
| P | |
| Palette | 431, 432 |
| Parmesan-Menagen | 376 |
| Party-Löffel | 27, 104, 105, 242 |
| Partyplatte | 138, 139 |
| Passiermühle | 404 |
| Passiersieb | 403 |
| Pastetenform | 407 |
| Permanent-Ausgießer | 319 |
| Pfanne | 400, 401 |
| Pfannenwender | 432-435 437, 439, 440 |
| Pfeffermühlen | 381, 382 |
| Pinself | 411 |
| Pitcher | 302 |
| Pizzaform/-bleche | 401 |
| Pizzaroller/-heber/-schaufel/-schieber | 411, 425, 435 |
| Platzteller | 123 |
| Pommes-Frites Schaufel | 442 |
| Pommes-Frites Seiher | 403, 408 |
| Portionierer | 443 |
| Portionsspender | 387 |
| Porzellan-Einsatz | 248 |
| Q | |
| Quetschflasche | 410 |
| R | |
| Rechnungstablett | 153 |
| Rechteckschalen/Wanne | 281 |
| Regalwagen | 285 |
| Reinigungsbürste für Ausgießer | 322 |
| Reserviert-Schild | 329 |

| | |
|---------------------------|--------------------|
| Rezeptionsglocke | 318 |
| Rolltop Deckel Kunststoff | 457, 458 |
| Rolltop-Deckel Edelstahl | 258 |
| Rolltop-Set | 164, 170, 203 -215 |
| Rost | 273 |
| Rüthrglas | 309 |

S

| | |
|--|--------------------------------|
| Saft/Milch Dispenser | 229 -237 |
| Salatgabel/-löffel | 438, 447 |
| Salatschleuder | 408 |
| Salz-/Pfefferstreuer | 383, 384 |
| Salzmühlen | 381 |
| Saucengießlöffel | 448 |
| Sauciere | 149 |
| Sauciere Thermo | 149 |
| Schälchenspender | 200, 201 |
| Schale Edelstahl/Glas | 160, 161, 171 |
| Schale Melamin, Blatt | 27, 90, 91 |
| Schale/Schüssel Melamin | 19-23, 28 45-103 |
| Schäler Spargel/Orange/Sparschäler | 423, 424 |
| Schaufel Pommes-Frites /Eis/ Mehl / Mehrzweck | 404, 442, 452 |
| Schaumlöffel | 287, 438, 439 |
| Schaumspesiering/-form | 406 |
| Schieferplatte Natur | 118, 119 |
| Schilder für Buffet | 329-333 |
| Schilderhalter | 329-333 |
| Schlüsselschnur | 322 |
| Schneebesen/Kesselbesen | 441, 442 |
| Schöpflöffel | 436, 438-440 |
| Schüssel Edelstahl | 160, 161 |
| Schüssel Melamin, Palmblatt | 27, 90, 91 |
| Schüssel Wasserbad | 404 |
| Schutzdeckel | 461, 462 |
| Seiher | 403, 408 |
| Sektflaschenverschluss | 320, 321 |
| Sektkühler | 290-302 |
| Sektkühlerständer | 293 |
| Senftöpfchen | 373 |
| Service Tower | 197 |
| Servier-/Buffetplatte Porzellan | 162 |
| Servier-/Tortenplatte Edelstahl | 142 146, 147, 417, 418 |
| Servier-/Tortenplatte Melamin | 24, 418 419 |
| Servier-/Transportwagen | 284, 285 |
| Serviergestell | 87, 88, 125, 180-182 |
| Servierlöffel | 109, 436, 439, 440, 446 447 |
| Servierpfanne Schmiedeeisen/Eisen | 400, 401 |
| Servierpfanne/Beilagenschale | 143, 144 |
| Servierschale | 143, 144, 265 |
| Serviertablett | 154-159 |
| Serviettenhalter | 392, 393 |
| Serviettenringe | 389 |
| Shaker | 308, 309 |
| Sicherheitsbrenner Hot&Safe | 261 |
| Sieb Suppe/Passier/Gaze | 402-404 |
| Snack-Holder | 114 |
| Snackpresenter | 224 |
| Spachtel | 432, 434 |
| Spaghettilöffel/-zange | 438, 439, 448 451 |
| Spargelschäler | 423 |
| Speisekartenhalter | 332, 333 |
| Speisenwärmer/Stövchen | 265, 266 |
| Spießaufhänger | 443 |
| Spieße Holz/Edelstahl | 241, 443 |
| Spritzbeutel | 414 |
| Standascher | 327, 328 |
| Ständer Bankettkarten | 333 |
| Ständer Eiswaffel | 420 |
| Ständer Küchentuch | 412 |

| | |
|----------------------------|--------------------|
| Ständer Schneidbrett | 413 |
| Ständer Weinkühler | 293 |
| Staubkappen | 322 |
| Stößel | 307 |
| Stövchen | 265, 266 |
| Streichpaletten | 431 |
| Streuer Käse/Gewürz | 383 |
| Streuer Salz/Pfeffer | 383, 384 |
| Suppenkelle | 436, 438, 439, 447 |
| Suppentopf / Suppenstation | 258-260 |
| Sushiboard / Sushiplatte | 59, 59 |

T

| | |
|---------------------------------------|--|
| Table Caddy | 370 |
| Tablett Edelstahl | 128-145 |
| Tablett Edelstahl mit Haube | 134, 142 |
| Tablett Edelstahl, Buffet | 129, 135 |
| Tablett Edelstahl, System | 127, 130 131, 133, 134 |
| Tablett Fastfood | 155 |
| Tablett Holz | 29 |
| Tablett Kaffeehaus 1 | 58, 159, 388 |
| Tablett Melamin | 25, 30, 31, 36-52 57-63, 67-70, 73, 77, 79, 82-85 |
| Tablett/Bierglasträger | 154-157 |
| Tablett/Partyplatte | 138, 139 |
| Teebeutel Ablage/Halter | 391 |
| Teebox | 390 |
| Teebrühsieb | 391 |
| Teigschneider / -schaber | 425, 435 |
| Teiler Apfel/Zwiebel | 431 |
| Teller Melamin | 49-51, 57, 62, 83, 102 |
| Thekenaufsatz/Vitrine/Mini-Theke | 223 |
| Thermo Set/Tablett | 208-215 |
| Thermo-Box | 282, 283 |
| Tischaufsteller/-kartenhalter/-nummer | 329-333 |
| Tischkrümel-Entferner | 398 |
| Tischrestebehälter | 394-398 |
| Tischsets, Tischläufer | 364-369 |
| Torten-/Dessertring | 415 |
| Tortenhaube | 459 |
| Tortmesser/-heber | 448 |
| Tortenplatte | 146-148, 417-420 |
| Tortenteiler | 416 |
| Tourniermesser | 428 |
| Tretabfallbehälter | 328 |
| Tüllenkassetten | 414 |
| Türsymbole | 335 |

U

| | |
|----------------|-----|
| Universalbox | 174 |
| Universalkanne | 405 |
| Untersetzer | 123 |

V

| | |
|----------------------------|-----|
| Vakuum-Pumpe Ersatzstopfen | 320 |
| Vakuum-Pumpe Wein | 320 |
| Vase | 336 |
| Verschuß Wein/Champanger | 321 |

W

| | |
|--------------------|----------|
| Wachspapier | 117 |
| Wagen | 284, 285 |
| Wanne | 281 |
| Wärme-Kies | 255 |
| Weck-Glas | 124-127 |
| Wein- / Sektkühler | 290-302 |
| Weinausgießer | 320 |
| Weinex-Ausgießer | 320 |
| Weinflaschenhalter | 324 |
| Wender | 431-446 |
| Windlicht | 340-342 |
| Winkelpaletten | 432, 433 |
| Windaschenbecher | 325, 327 |

Z

| | |
|----------------------------|---------------------|
| Zange Salat/Toast/Allzweck | 438, 445 448-450 |
| Zapfhahn | 323 |
| Ziseliermesser | 424 |
| Zitronen-/Limettenpresse | 314 |

| | |
|----------------------------|----------|
| Zitronenschnitzpresse | 391 |
| Zitruspresse | 314 |
| Zuckerdose/-kugel/-spender | 387 |
| Zuckerdosierer | 378, 379 |
| Zuckertüten-Box | 387 |
| Zutatenbehälter | 411 |

Index Art.-Nr. 463-466

ENGLISH

| item | page |
|---|--------------------------------|
| A | |
| adapter | 271 |
| apple / onion divider | 431 |
| apple corer/courgette / zucchini cutter | 427 |
| ashtray/litter bin | 325-328 |
| asparagus knife | 423 |
| asparagus knife / asparagus peeler/ orange peeler/peeler | 423, 424 |
| B | |
| bain marie bailing bowl | 404 |
| baking mittens | 411 |
| baking sheet | 401, 415, 416 |
| baking tray | 416 |
| bar knife | 307, 429 |
| bar-set/bar spoon/bar strainer/bar caddy | 308, 311 |
| barbecue tong | 449 |
| basket | 344-359, 360, 363 |
| basket for bread or fruits/bowl | 362 363 |
| beer rack | 317 |
| Biatelli | 388 |
| bill presenter | 153 |
| bill rail/bill spike | 413 |
| board | 29, 112-113, 136, 144 |
| boston shaker | 308, 309 |
| bottle cap opener/bottle cap holder | 312, 313 |
| bottle rack | 317 |
| bowl | 19, 21, 92 |
| bowl holder | 200, 201 |
| bowl melamin | 19-28, 42-103 |
| box / sweetbox | 174 |
| bread basket with cherry stones pillow/ canvas bag | 360 |
| bread buffet | 221, 223, 346 |
| breadstick holder | 362 |
| brush | 411 |
| buffet ladder | 186-189 |
| buffet pyramid | 238-242 |
| buffet stand | 80, 87-88, 186-187 219, 220 |
| buffet stand for baskets | 178, 186-189 359 |
| buffet stand, riser with cover | 29, 33 110, 145, 176, 177 |
| buffet-tray | 129, 135 |
| burner holder | 261 |
| butter curler | 425 |
| butter dish | 150 |
| C | |
| cake / quiche mould | 415 |
| cake lifter | 432, 448 |
| cake marker | 416 |
| cake plate | 146, 147, 417-419 |
| cake setting ring/dessert and tart ring | 415 |
| cake slice/cake lifter | 448 |
| cake tray/plate | 24, 418, 419 |
| cake tray/plate | 146-148, 417-420 |
| canapé forks | 104-105, 161, 242 |
| candleholder/wind light | 337-342 |
| canister with spoon | 412 |
| caviar cooler | 160 |
| cereal dispenser/cereal-bar | 166 193-196 |
| cereal pitcher | 193, 194 |
| Chafing Dish | 244-258 |
| champagne bowl | 294-297 |
| champagne conservator | 320 |
| champagne saver | 319, 320 |
| cheese dish | 206, 207 |
| cheese dish | 376 |

| | | | | | | | |
|---|-----------------------------------|---------------------------------------|--------------------|--|-------------------------|--|------------------------------|
| cheese knife | 429, 430 | GN tray | 30, 31 | non-stick loaf tin | 407 | soup bowl | 247 |
| chip bagger/chip shovel/scoop | 404 | 37, 40, 41, 45-49, 63, 69, 70, 73 | | O | | soup ladle | 436, 438, 439, 447 |
| | 442, 452 | 77, 79, 82-85, 122, 128-136, 137-140 | | olive-oil can | 405 | soup warmer | 247, 253, 258-260 |
| citrus squeezer/lime press | 314 | GN-container melamin | 276, 277 | oyster knife | 427 | space box | 383 |
| clingfilm tear-off-dispenser, single | 420 | GN-container polycarbonate | 274 | P | | spaghetti spoon/spoon | 438, 439 |
| cloche / dome cover | 25, 123 | GN-container polypropylene | 275 | palette | 431, 432 | | 448, 451 |
| coaster | 123 | GN-container porcelain | 276 | paper towel holder/kitchen roll holder | | spatula | 432, 434 |
| coffe cup | 102 | GN-convention oven trays | 272 | | 412 | spirit measure | 318-320 |
| coffee dispenser | 228, 251 | GN-cover, airtight | 272 | paring knife | 428-429 | spits/skewer | 241, 443 |
| coffee pot | 388 | GN-drainer | 274 | party spoon | 27, 57, 60, 61, 97, 104 | spoon | 109, 436, 439, 440, 446, 447 |
| condiment container | 411 | GN-grids / -shelves | 273 | | 105, 242 | squeeze bottle | 410 |
| condiment holder | 411 | GN-lid with rubber seal | 271 | partytray | 138, 139 | stainless bowl, double wall | 160, 161 |
| confectionery funnel | 409 | GN-pans with folding handles | 271 | pasta machine | 409 | stainless bowl, double wall/bowl | 160 |
| conference bottle cooler | 298 | gourmet spoons | 242 | pastry bag | 414 | | 161, 171 |
| container | 281 | gourmet-Display | 238-242 | pedal bin | 328 | stand for wine cooler | 293 |
| container/cutlery basket/dispenser/ | | graduated jug | 385, 405 | pepper mill | 381, 382 | stand/bowl | 45, 47, 51, 53, 55, 59, 61 |
| cutlery box/table waste bin / cutlery bin | | granite chips | 255 | perforated GN-container | 270 | 65-68, 71, 73-80, 84-86, 89-91 | |
| | 167, 174, 197, 273, 278-280 | grapefruit knife | 428 | pineapple slicer & wedger | 314 | stopper | 317, 320-322 |
| cool bowl | 160, 161, 165, 172, 173 | gravy boat | 149 | pipng tubes set | 414 | strainer/conical strainer with wire | |
| | 216-218 | greaseproof paper squares | 117 | pitcher | 302 | gauze | 402-404 |
| cool collar | 303 | H | | pitcher/cooling carafe/juice / water | | sugar bowl/sugar pot/sugar pourer | 387 |
| cooler | 290-292, 294-303, 462 | hammer wood | 323 | pitcher/bottle | 225-227, 302 | sugar dispenser | 378, 379 |
| cooling plate/showcase | 191, 203 | heating element | 263 | pizza dish | 401 | sugar pocket holder | 387 |
| | 208, 210 | heating unit | 245, 251, 262, 263 | pizza peel/pizza cutter | 411, 425, 435 | sugar-creamer-set | 386 |
| corer | 426, 427 | high Tea Rack | 175 | placemat wide band/table runner fine | | T | |
| cornet stand | 420 | hot plate | 263 | fabric | 364-369 | table caddy | 370 |
| cover | 25, 29, 113, 134, 148, 170, 171 | hygienic cover | 222, 223 | plate / cake plate | 142, 146, 147 | table stand/sign | 329-333 |
| | 191, 203, 205 - 215, 220, 456-460 | I | | | 417, 418 | table waste bin / cutlery bin / box | |
| cover for bain marie | 259 | ice ball former/cooler for 4 shooters | | plate tray | 123 | | 328, 394-398 |
| cover hinged | 461, 462 | | 306 | plate warmer/warmer | 265, 266 | tap, brass | 323 |
| cover, SAN | 72, 79, 85 | ice box/ice bucket | 303-305 | plate, rotating | 119, 241 | tea bag rest, 2 pcs. Set/tea bag caddy | |
| crumber | 398 | ice crusher | 306 | plate, round | 49-51, 57, 62, 83, 102 | | 391 |
| curler/cheese slicer | 185, 409, 430 | ice scoop | 312, 452 | porcelain insert | 248 | tea-box | 390 |
| cutlery basket | 278 | ice tong | 310 | portioner / ice cream scoop | 443 | thermo tray | 208-215 |
| cutlery rest/cutlery basket/cutlery | | imitation replica fruits | 179 | potato holder | 426 | thermobox | 282, 283 |
| dispenser | 167, 174, 197, 278-280 | induction plate for chafing dish | 262 | pourer | 378, 379 | timber trestle | 323 |
| cutting board | 170, 221, 222 | | 263 | pourer cleaning brush | 322 | tray | 127, 128-145, 130, 131 |
| cutting board rack | 413 | insulated dispenser | 228 | pouring container | 316, 410 | | 133, 134, 135, 154-159, 388 |
| D | | insulated sauce boat | 149 | pretz- sausage stand | 185 | tray „NON Slip“ | 154-157 |
| dariol moulds | 407 | J | | R | | tray melamin | 25, 30, 31, 36-52, 57-63 |
| decorating knife | 424 | jigger | 310 | refillable burner | 261 | | 67-70, 73, 77, 79, 82-85 |
| decorator / radish decorator | 427 | juice dispenser/milk dispenser | 229-237 | refrigerator butter dish | 150 | tray with cover | 134, 142 |
| decorator / zester | 424 | juicer | 314 | ring bell | 318 | tray, sushiboard | 59, 59 |
| delicatessen spoon/salad spoon/ | | julienne cutting knife | 429 | roll dispenser | 221, 223, 346 | trolley/serving trolley | 285 |
| dressing spoon | 106, 107 | K | | rolltop cover | 462, 457, 458 | turner | 431-446, 437, 439, 440 |
| dish | 162 | key cord | 322 | rolltop-set | 168-173, 203-215, 221 | V | |
| dispenser | 316, 387 | knife cleaner | 420 | S | | vacuum wine pump | 320 |
| display tray | 416 | knife rest | 389 | salad fork/salad spoon | 438, 447 | vinegar-& oil menage | 371-375 |
| dressing pot/bowl, double wall | 106 | L | | salad spinner | 408 | W | |
| | 161, 162 | ladle | 436, 438-440 | salad tong/Toast-Zange/multipurpose | | waiter's barblade | 312, 313 |
| drip mat | 318 | leaf | 27, 90, 91 | tong | 438, 445, 448-450 | waiter's corkscrew | 312, 313 |
| dust & fly cap | 322 | leaf/bowl | 27, 90, 91 | salt - and pepper shaker/salt cellar | | warmer | 264 |
| E | | lemon slice squeezer | 391 | | 383, 384 | Weck-glasses | 124-127 |
| egg cutter | 151 | lime press | 314 | salt mill | 381 | whisk/large whisk | 441, 442 |
| egg holder | 151 | M | | sandwich knife | 434 | wind lights | 340-342 |
| eggs-box/egg basket | 151 | magnetic knife rack | 413 | sauce / gravy ladle | 448 | wine / champagne bowl | 290-302 |
| etagère | 179-184 | meat fork/fork | 286, 287, 436 | service tower | 197 | wine nozzle | 320 |
| expandable dough cutter/dough scraper | | | 440, 446 | serving dish | 115, 116, 143, 144, 265 | wine pump stopper | 320 |
| | 425, 435 | meat platter | 135, 137, 145 | | 400, 401 | wine stopper | 321 |
| F | | melon baller | 422, 423 | serving stand | 87, 88, 125, 180-182 | winebottle-stand | 324 |
| fire tong | 264 | menage | 371-377 | serving trolley | 284, 285 | wrought-iron pan | 400, 401 |
| fish platter/fish bowl | 94, 95, 144 | menu cover | 332 | set measuring spoon | 444 | | |
| fish scaler/fish tong | 430 | menu stand / table number | 333 | shelf bracket with spirit measure | 318 | index item-no. | 463-466 |
| flower vase | 336 | milk / cream jug/milk/cream jugs | 378 | showcase | 170, 205, 207-214, 223 | | |
| frame for induction plate | 263 | | 379, 386 | sign holder | 329-333 | | |
| frames | 168-174 | milk dispenser | 234, 235, 385 | sign holders, with 10 signs | 330 | | |
| free flow pourers | 318 - 320 | mill | 381, 382 | sign plate | 335 | | |
| fruit decorating knife | 426, 428 | mixing glass with lip | 309 | signs set | 331, 329-333, 334 | | |
| frý dripping tray/colander | 403, 408 | moulin / sieve | 404 | skewer / espetada and kebab skewer | | | |
| G | | mousse ring/mousse mould | 406 | rack | 443 | | |
| gastronorm-container | 268-272 | muddler | 307 | skimmer | 287, 438, 439 | | |
| glass carry box | 280 | multi rack | 175-177 | skimmer - mesh/birds nest fryer | 402 | | |
| glass plate clips/glass rack | 317 | mussel bowl/mussel pot | 160 | skimmer / spider | 402 | | |
| glass platter/buffet glass plate | 122 | mustard glass | 373 | snack tray | 155 | | |
| glass rimmer | 305 | N | | snack-Holder | 114 | | |
| | | napkin holder | 389, 392, 393 | snackpresenter | 224 | | |
| | | natural slate tray GN | 118, 119 | snap mesh tea ball | 391 | | |

ESPAÑOL

artículos pág.

| | |
|---|--------------------|
| A | |
| abre ostras | 427 |
| abridor camarero | 312, 313 |
| abridor de botellas/recogedor de chapas | 312, 313 |
| aceitera | 405 |
| acumulador de frío | 462 |
| adaptador | 271 |
| aros tarta/aro de tarta | 415 |
| azucarero | 378, 379 |
| azucarero pequeño | 387 |
| B | |
| bajo plato | 123 |
| bandeja 127-145, 154-159, 179-184 | |
| bandeja „antideslizante“ | 154-157 |
| bandeja aperitivos | 155 |
| bandeja autoservicio y snacks | 155 |
| bandeja con tapa | 134, 142 |
| bandeja de buffet | 129, 135 |
| bandeja de fiesta | 138, 139 |
| bandeja de fiesta/bandeja party | 138, 139 |
| bandeja de pizarra natural GN | 118, 119 |
| bandeja interior de porcelana | 248 |
| bandeja melamin 25, 30, 31, 36-52 | |
| 57-63, 67-70, 73, 77, 79, 82-85 | |
| bandeja para cerveza | 317 |
| bandeja para sushi | 59, 59 |
| bandeja pastelera | 416 |
| bandeja refrigerada/vitrina de bufet | 191 |
| 203, 208, 210 | |
| bandeja termo | 208-215 |
| bandeja vidrio, espejo/fuente de bufet | |
| para cristal | 122 |
| bandeja/fuente de servicio | 135 |
| banqueta de madera | 323 |
| barra magnética para cuchillos | 413 |
| base giratoria | 119, 241 |
| batidor/batidor gigante | 441, 442 |
| biatelli | 388 |
| bol alto para aliño/salsera alta/salsera alta | |
| doble pared | 106, 161, 162 |
| bol azucar/azucarero/dispensador de | |
| azúcar | 387 |
| bol de acero inoxidable, doble pared | |
| 160, 161 | |
| bol de acero inoxidable, doble pared/bol | |
| 160, 161, 171 | |
| bol para marisco/mejillonera | 160 |
| bol refrigerado | 160, 161, 165, 172 |
| 173, 216-218 | |
| bomba de vacío para vino | 320 |
| bote con cuchara | 412 |
| bote contenedor | 316, 410 |
| bote dosificador/bote dosificador flexible | |
| 410 | |
| bread buffet | 221, 223, 346 |
| brocha | 411 |
| C | |
| caddy de mesa | 370 |
| cafetera | 388 |
| caja de 12 boquillas | 414 |
| caja para huevos/cesta de huevos | 151 |
| caja para te | 390 |
| caja para transporte de vasos | 280 |
| calentador para quemada | 264 |
| calienta platos/caliente | 265, 266 |
| campana | 25, 123 |
| campana abatible | 457, 458 |
| campana rolltop | 258 |
| carro de servicio | 284, 285 |
| carro/carro de servicio | 285 |
| cazo para baño maría | 404 |
| cenicero/papelera con cenicero superior | |
| 325-328 | |

| | |
|---|--------------------|
| centrifugadora de ensalada/ | |
| escurridorverduras | 408 |
| cepillo de limpieza para picos vertedores | |
| 322 | |
| cesta | 344-359, 360, 363 |
| cesta de pan con cojin de huesos de | |
| cereza/cesta de tela para el pan | 360 |
| cesta para cubiertos | 278 |
| cesta para pan o fruta/bol | 362, 363 |
| chafing Dish | 244-260 |
| champañera | 290-302 |
| coctelera boston | 308, 309 |
| colador/colador chino de malla | 402-404 |
| coletor a pedal | 328 |
| conjunto de bar/cucharilla de cóctel/ | |
| colador de cóctel/organizador de bar | |
| 308, 311 | |
| cortador 5 ruedas lisas/corta pasta | |
| 425, 435 | |
| cortahuevos | 151 |
| cubeta | 281 |
| cubeta GN antiadherente para hornos de | |
| convección | 272 |
| cubeta GN policarbonato | 274 |
| cubetas gastronorm | 268-272 |
| cubetas GN melamin | 276, 277 |
| cubetas GN perforado | 270 |
| cubetas GN polipropileno | 275 |
| cubetas GN porcelana | 276 |
| cubetas/dispensador de cubiertos/ | |
| dispensador de cubiertos/cesta para | |
| cubiertos/papelera de sobremesa | |
| 167, 174, 197, 273, 278-280 | |
| cubierta 25, 29, 113, 134, 148, 170, 171 | |
| 191, 203, 205-215, 220, 456-460 | |
| cubierta higiénica | 222, 223 |
| cubitera | 303-305 |
| culo champañera | 294-297 |
| cuchara de servicio 109, 436, 439, 440 | |
| 446, 447 | |
| cuchara de spaghetti/pinza | 438, 439 |
| 448, 451 | |
| cuchara party 27, 57, 60, 61, 97, 104 | |
| 105, 242 | |
| cucharas gourmet | 242 |
| cucharas gourmet/cucharas/cuchara de | |
| aliño | 106, 107 |
| cucharón | 436, 438-440 |
| cucharón de salsa | 448 |
| cucharón de sopa | 436, 438, 439, 447 |
| cuchillo curvado | 428 |
| cuchillo de decoración | 424 |
| cuchillo de queso | 429, 430 |
| cuchillo par pomelo | 428 |
| cuchillo para cóctel | 307, 429 |
| cuchillo para cortar juliana | 429 |
| cuchillo para pelar/cuchillo mondador | 429 |
| cuchillo para untar | 434 |
| cuenco melamin 19-28, 42-103 | |
| cuencos para salsas 19, 21, 92 | |
| cuhillo para decorar fruta | 426, 428 |
| D | |
| decorador | 424 |
| decorador/cinzelador triangular | 427 |
| dispensador | 174, 316 |
| dispensador de bocadillos | 224 |
| dispensador de café | 251 |
| dispensador de cereales/barra para | |
| dispensador de cereales 166, 193-196 | |
| dispensador de especias | 411 |
| dispensador de film | 420 |
| dispensador de leche 234, 235, 385 | |
| dispensador de panecillos 221, 223, 346 | |
| dispensador de servilletas/soporte papel | |
| cocina | 412 |
| dispensador de zumo/dispensador de | |
| leche 229-237 | |

| | |
|---|----------|
| dispensador en escalera | 175-177 |
| dispensador isotérmico | 186-189 |
| 228 | |
| dispensador/dispensador para servicio | |
| bebidas calientes | 387 |
| dosificador | 378, 379 |
| dosificador de licores | 318-320 |
| E | |
| embudo dosificador | 409 |
| enfriador 290-292, 294-303 | |
| enfriador de caviar | 160 |
| enfriador múltiple | 298 |
| escamador/pinza de pescado | 430 |
| escurridor de fritos | 403, 408 |
| escurridor de fritos/colador en formato | |
| 403, 408 | |
| escurridor GN | 274 |
| espátula 431-435, 437, 439, 440 | |
| especiero | 383, 411 |
| espumadera 287, 402, 438, 439 | |
| espumadera de malla/espumadera de nido | |
| 402 | |
| esterilla escurridora/tapete escurridor | 318 |
| estructura o marco para placa de | |
| inducción | 263 |
| expositor 87, 88, 125, 180-182 | |
| expositor organizador/bol 45, 47, 51, 53 | |
| 55, 59, 61 | |
| 65-68, 71, 73-80 | |
| 84-86, 89-91 | |
| exprimidor | 314 |
| exprimidor cítricos/prensa de lima | 314 |
| F | |
| florero | 336 |
| frames | 168-174 |
| fuelle | 162 |
| fuelle de carne 135, 137, 145 | |
| fuelle de servir | 400, 401 |
| fuelle de servir/fuelle de servicio | |
| 143 | |
| 144 | |
| fuelle en forma de hoja 27, 90, 91 | |
| fuelle en forma de hoja/fuelle en forma | |
| de hoja de palmera 27, 90, 91 | |
| fuelle honda 115, 116, 143, 144, 265 | |
| fuelle pescado/cuenco para pescado | |
| 94 | |
| 95, 144 | |
| funda de frío | 303 |
| funda para carta | 332 |
| G | |
| GN bandeja 30, 31, 37, 40, 41 | |
| 45-49, 63, 69, 70, 73, 77, 79, 82-85, 122 | |
| 128-136, 137-140 | |
| GN cubetas con asas abatibles | 271 |
| gourmet-Display | 238-242 |
| granulado térmico | 255 |
| H | |
| huevo | 151 |
| I | |
| imitaciones de alimentos Replica | 179 |
| indicadores de porcelana | 329-334 |
| infusor de te | 391 |
| J | |
| jarra | 302 |
| jarra de cereales | 193, 194 |
| jarra graduada | 385, 405 |
| jarra medidora universal | 405 |
| jarra/decantador/Jarra para zumo/ agua/ | |
| botella 225-227, 302 | |
| juego 2 flaneras | 407 |
| juego 2 piezas vasos mostaza | 373 |
| juego 5 piezas aros para emplatar/juego 5 | |
| piezas molde para emplatar | 406 |
| juego de 2 piezas de sal y pimienta | |
| 383, 384 | |
| juego de cucharas medidoras | 444 |

| | |
|--------------------------------------|---------------|
| L | |
| leche/ crema/jarras de leche/ crema | 378 |
| 379, 386 | |
| limpiador de cuchillos | 420 |
| llavero enrollable | 322 |
| M | |
| manga pastelera | 414 |
| manoplas de cuero | 411 |
| mantelinas de mesa/camino de mesa | |
| 364-369 | |
| mantequillera | 150 |
| mantequillera para nevera | 150 |
| máquina de pasta | 409 |
| marcador de pasteles | 416 |
| marmita de sopa | 247 |
| martillo de madera | 323 |
| medidor | 310 |
| menaje/conjunto aperitivo | 371-377 |
| molde de cubitos de hielo esféricos/ | |
| moldes para 4 cubitos de hielo | 306 |
| molde de pizza | 401 |
| molde pate o pastel liso | 407 |
| molde tarta o quiche | 415 |
| molinillo | 381, 382 |
| molinillo de pimienta | 381, 382 |
| molinillo de sal | 381 |
| molinillo/ colador | 404 |
| mortero | 307 |
| P | |
| pala de hielo | 312, 452 |
| pala de pizza/cortador de piza | 411, 425 |
| 435 | |
| pala para tarta | 432, 448 |
| paleta triangular | 432, 434 |
| papel alimenticio para cucurucho | 117 |
| papelera de sobremesa | 328, 394-398 |
| para presentar cuenta | 153 |
| pelador de espárragos | 423 |
| pelador de espárragos/pelador de | |
| naranjas/pelador de espárragos | 423, 424 |
| pelador y cortador de piña | 314 |
| picadora de hielo | 306 |
| pictogramas | 335 |
| pie porta cubos | 293 |
| pinchos/piezas | 241, 443 |
| pinza ensalada/pinza bocadillo/pinza | |
| multi-usos 438, 445, 448-450 | |
| pinza exprimelímón | 391 |
| pinzas barbaoco | 449 |
| pinzas para cubitos de hielo | 310 |
| pinzas sujeteta copas/rack de copas | 317 |
| pirámide buffet | 238-242 |
| placa caliente | 263 |
| placa de inducción para chafing dish | |
| 262, 263 | |
| placa pastelera | 401, 415, 416 |
| plato redondo 49-51, 57, 62, 83, 102 | |
| porcionador de manzana -cebolla | 431 |
| porcionador de pastel/pala de tartas | 448 |
| porta botellas | 317 |
| porta grissini | 362 |
| porta indicadores, 10 indicadores | 330 |
| porta tartas 142, 146, 147, 417, 418 | |
| 146-148, 417-420 | |
| porta tartas/porta tartas confiteria | |
| 147, 417-419 | |
| portafichas/pinchanotas | 413 |
| portavelas antiviento | 340-342 |
| portavelas/porta velas | 337-342 |
| posavasos | 123 |
| prensa de limón/lima | 314 |
| Q | |
| quemador recargable | 261 |
| quesera | 206, 207 |
| quesera | 376 |

| | |
|--|--------------------------------|
| R | |
| racionador/ cuchara para helado | 443 |
| rack de te alto | 175 |
| recogemigas | 398 |
| recogedor para patatas fritas/pala para patatas fritas/pala | 442, 404, 442, 452 |
| rejillas GN | 273 |
| reposa cuchara/cesta para cubiertos/ dispensador de cubiertos | 167, 174, 197 278-280 |
| reposa cuchillos | 389 |
| resistencia | 245, 251, 262, 263 |
| ribeteador de vasos | 305 |
| rizador de mantequilla | 425 |
| rizador/rebanador de queso | 185, 409, 430 |
| S | |
| sacacorchos de camarero | 312, 313 |
| salsera | 149 |
| salsera isotérmica | 149 |
| sartén forjada | 400, 401 |
| service tower | 197 |
| servilletero | 389, 392, 393 |
| set de aceite y vinagre | 371-375 |
| set de dos piezas para bolsita de te/porta bolsitas de te | 391 |
| set para azúcar y crema | 386 |
| set roll top | 168-173, 221, 206-215 |
| set rolltop | 164, 170, 203-215 |
| Snack-Holder | 114 |
| soporte 1 botela con medidor licores | 318 |
| soporte botellas vino | 324 |
| soporte bufé | 80, 87-88, 186-187 219, 220 |
| soporte de cestas para bufet | 178 186-189, 359 |
| soporte de mesa para carta/porta-etiqueta o carta de sobremesa con pinza | 333 |
| soporte para bol | 200, 201 |
| soporte para brochetas | 443 |
| soporte para bufet, display con tapa | 29, 33, 110, 145, 176, 177 |
| soporte para cartelito | 329-333 |
| soporte para cornetes | 420 |
| soporte para el quemador | 261 |
| soporte para embutidos | 185 |
| soporte para tablas | 413 |
| soportes/placa 2 pz. | 329-333 |
| soporte/soporte para quemada | 264 |
| T | |
| tabla de corte | 170, 221, 222 |
| tabla para el buffet | 29, 112-113 136, 144 |
| tapa GN hermética | 272 |
| tapa GN ranurada sellada/tapa GN hermética con junta | 271 |
| tapa para baño maría | 259 |
| tapa protección | 461, 462 |
| tapa, SAN | 72, 79, 85 |
| tapete escurridor | 318 |
| tapón | 322 |
| tapón conservador | 320 |
| tapón de latón | 323 |
| tapón para el cava | 319, 320 |
| tapón para vino | 321 |
| tapones | 320-322 |
| tapones al vacío para el vino | 320 |
| tapones set de 4 unidades | 317 |
| taza de café | 102 |
| tenedor aguanta patatas | 426 |
| tenedor de carne/tenedor | 286, 287, 436 440, 446 |
| tenedor para ensalada/cuchara para ensalada | 438, 447 |
| tenedores canapé | 104-105, 161, 242 |
| termobox | 282, 283 |
| timbre | 318 |

| | |
|---|-------------------|
| V | |
| vaciador | 426, 427 |
| vaciador de manzana/vaciador para calabacín | 427 |
| vaciador de melón | 422, 423 |
| vasito con tapa | 124-127 |
| vaso mezclador vertedor con tapa/vaso mezclador vertedor con pico | 309 |
| vertedor de vino | 320 |
| vertedores continuos | 318-320 |
| vitrina de bufet | 170, 205, 207-214 |
| vitrina de mostrador | 223 |
| índice artículos-no. | 463-466 |

FRANÇAIS

| | |
|--|------------------------------------|
| item | pág. |
| A | |
| accumulateur de froid | 462 |
| adaptateur | 271 |
| anneau à serviettes | 389 |
| anti-glisse | 154-157 |
| assiette | 49-51, 57, 62, 83, 102 |
| assiette de présentation | 123 |
| B | |
| bac à vaisselle | 281 |
| bac GN anti-adhérent pour fours à convection | 272 |
| bac GN polycarbonate | 274 |
| bac récupérateur de capsules/décapsuleur mural | 312, 313 |
| bac supérieur en porcelaine | 248 |
| bac/bac à vaisselle | 281 |
| bacs gastronome | 268-272 |
| bacs Gastronorme melamin | 276, 277 |
| bacs Gastronorme porcelaine | 276 |
| bacs GN avec anses abattantes | 271 |
| bacs GN en polypropylène | 275 |
| bacs GN perforés | 270 |
| bar à céréales/distributeur de céréales | 166, 193-196 |
| barre aimantée pour couteaux | 413 |
| base tournante | 119, 241 |
| becs verseurs | 320 |
| beurrier | 150 |
| boîte à beure pour le frigo | 150 |
| boîte à épices ou ingrédients | 411 |
| boîte à fruits et ingrédients | 411 |
| boîte à oeufs/panier à oeufs | 151 |
| boîte à thés et infusions | 390 |
| boîte de 12 douilles | 414 |
| bol | 19-23, 28, 45-103 |
| bol inox double paroi/bol verre | 160 161, 171 |
| bol inox double paroi/saladier | 160, 161 |
| bol melamin | 19-27, 42-103 |
| bols réfrigérés | 160, 161, 165, 172 173, 216-218 |
| bordeur à verres „rimmer“ | 305 |
| bouchon à champagne | 319, 320 |
| bouchon à vin | 321 |
| bouchon anti-poussières et anti-insectes | 322 |
| bouchon de conservation | 320 |
| bouchon en laiton/robinet bois | 323 |
| bouchons | 320-322 |
| bouchons verseurs continus | 318-320 |
| boule à thé avec pince | 391 |
| bouteille „store & pour“ | 316, 410 |
| bouteille verseuse souple | 410 |
| brosse lave-bouchons doseurs | 322 |
| broyeur à glaçons | 306 |
| brûleur | 261 |
| brûleur rechargeable | 261 |
| C | |
| caddy de table | 370 |
| cadre support inox pour plaque induction | 263 |
| cafetière Bialetti | 388 |
| caisse à verres | 280 |
| caisson à couverts ou multi-usages/bac/présentoir à couverts/poubelle de table | 167, 174, 197, 273, 278-280 |
| caisson à couverts ou multi-usages/boîte distributrice/poubelle de table | 174 |
| caisson thermo | 208-215 |
| casier | 324 |
| cercles à gâteaux | 415 |
| Chafing Dish | 244-258 |

| | |
|--|--|
| chafing dish 2 soupnières | 247, 253 258-260 |
| chandeliers/lampe à bougie | 337-342 |
| chariot de service | 284, 285 |
| chariot/chariot de service | 285 |
| chauffe-plat | 265, 266 |
| chauffe-plat spécial sucre flambé | 264 |
| clips porte-verre/rack porte-verres | 317 |
| cloche | 25, 29, 113, 134, 148 170, 171, 191, 203 205-215, 220, 456-460 |
| cloche demi-sphère | 25, 123 |
| cloche rolltop GN 1/1 | 457, 458 |
| coquetier | 151 |
| coquilleur à beurre | 425 |
| corbeille | 344-360, 363 |
| corbeille à couverts | 278 |
| corbeille à pain ou à fruits/bol à pain ou à fruits | 362, 363 |
| coupe-oeufs | 151 |
| coupe-pomme ou oignon en quartiers | 431 |
| couteau à fromage | 429, 430 |
| couteau à huîtres | 427 |
| couteau à julienne | 429 |
| couteau à pamplemousse | 428 |
| couteau à tarte/pelle à gâteau | 448 |
| couteau à tartiner | 434 |
| couteau ciseleur triangle | 427 |
| couteau cocktail | 307, 429 |
| couteau d'office | 429 |
| couteau d'office bec d'oiseau | 428 |
| couteau zesteur | 424 |
| couvercle avec charnière | 461, 462 |
| couvercle GN 1/1 du bain-marie | 259 |
| couvercle GN hermétique avec joint | 271 |
| couvercle hermétique GN | 272 |
| couvercle rolltop | 258 |
| couvercle SAN | 72, 79, 85 |
| crémier/pichet à eau ou lait | 378, 379 386 |
| cuillère à sauce | 448 |
| cuillère à spaghetti/pince universelle ou à spaghetti | 438, 439, 448, 451 |
| cuillère de service | 109, 436, 439 440, 446, 447 |
| cuillère party | 27, 57, 60, 61 97, 104, 105, 242 |
| cuillère/cuillères gourmet/cuillère à sauce | 106, 107 |
| cuillère/fourchette de service pour la salade/cuillère de service pour la salade | 438, 447 |
| cuillères gourmet | 242 |
| décapsuleur | 312, 313 |
| décore-citron ou zesteur | 424 |
| découpoir à bandes „bicyclette“/coupe-pâte | 425, 435 |
| denteleur | 426, 428 |
| dérouleur de film | 420 |
| dérouleur papier essuie-tout | 412 |
| dispositif pour nettoyer les lames de couteaux | 420 |
| D | |
| disributeur de petits pains | 221, 223 346 |
| disque à marquer les parts | 416 |
| distributeur à jus de fruit/distributeur à lait | 229-237 |
| distributeur de boisson isothermique | 228 |
| distributeur de café | 228, 251 |
| doseur | 378, 379 |
| doseur à alcool | 318-320 |
| doseur à sauce | 316 |

| | | | |
|--|---------------------------------------|--|--|
| E | | | |
| écailleur à poisson/pince pour le poisson | 430 | | |
| écumoire | 287, 438, 439 | | |
| écumoire à friture | 402 | | |
| écumoire toile métallique/pelle à friture rectangulaire | 402 | | |
| égouttoir à friture | 403, 408 | | |
| égouttoir GN | 274 | | |
| ensemble pyramide de buffet inox | 238-242 | | |
| entonnoir à piston | 409 | | |
| équeuteur à tomates | 426, 427 | | |
| essoreuse à salade | 408 | | |
| étagère à thé avec anse supérieure | 175 | | |
| étiquettes en porcelaine | 331, 334 | | |
| F | | | |
| fouet professionnel/fouet géant | 441, 442 | | |
| fourchette à viande/fouchette à viande | 286, 287, 436, 440, 446 | | |
| fourchettes a canapés | 104-105 | | |
| frames | 168-174 | | |
| frisette pour fromage et chocolat/ | | | |
| couteau tranche-fromage | 185, 409 | | |
| | 430 | | |
| G | | | |
| gants de boulanger | 411 | | |
| GN plat | 30 | | |
| | 31, 37, 40, 41, 45-49, 63 | | |
| | 69, 70, 7377, 79, 82-85 | | |
| | 122, 128-136, 137-140 | | |
| Gourmet-Display | 238-242 | | |
| gravier fin de granit | 255 | | |
| grille inox | 273 | | |
| H | | | |
| housse isotherme | 303 | | |
| I | | | |
| imitations d'aliments Réplica | 179 | | |
| J | | | |
| jeu de 2 moules à flan | 407 | | |
| jeu de cercles à mousse inox, ronds | 406 | | |
| jeu de cuillère à mesure | 444 | | |
| L | | | |
| louche | 436, 438-440 | | |
| louche de service | 436, 438, 439, 447 | | |
| M | | | |
| machine à pâtes | 409 | | |
| marmite à soupe électrique | 247 | | |
| marteau en bois | 323 | | |
| ménage huile et vinaigre | 371-375 | | |
| mesure double „jigger“ | 310 | | |
| mini cendriers/cendrier giratoire/ | | | |
| cendrier sur pied/poubelle ave cendrier supérieur | 325-328 | | |
| moule à glaçons en boules/moule 4 glaçons | 306 | | |
| moule à pizza | 401 | | |
| moule à pomme ou melon double | 422, 423 | | |
| moule à tarte ou quiche | 415 | | |
| moule à terrine lisse | 407 | | |
| moulin | 381,382 | | |
| moulin a poivre | 381, 382 | | |
| moulin a sel | 381 | | |
| P | | | |
| pain et buffet | 221, 223, 346 | | |
| panera con cojin/corbeille à pain en toile | 360 | | |
| papier alimentaire pour cornet | 117 | | |
| pare-haleine | 222, 223 | | |
| passoire | 403, 408 | | |
| pèle-ananas et coupe-quartiers | 314 | | |
| peleur à asperges | 423 | | |
| peleur à asperges/peleur à asperges/ | | | |
| peleur à oranges | 423, 424 | | |
| pelle à frites | 442 | | |
| pelle à frites/pelle à farine/pelle multi-usages | 404, 442, 452 | | |
| pelle à glaçons | 312, 452 | | |
| pelle à pizza/pelle à pizza/roulette à pizza/roulette à pâte, cannellée/coupe-pizza/coupe-pâte | 411, 425, 435 | | |
| pelle/plateau à gâteau | 432, 448 | | |
| petit banc en bois | 323 | | |
| petits chevalets de buffet | 329-333 | | |
| pic à pommes de terre | 426 | | |
| pic/brochettes | 241, 443 | | |
| pichet | 302 | | |
| pichet à café | 388 | | |
| pichet à céréales | 193, 194 | | |
| pichet gradué | 385, 405 | | |
| pichet mesureur universel | 405 | | |
| pichet verre/pichet rafraîchisseur/Pichet à eau ou jus de fruit/bouteille | 225-227 | | |
| | 302 | | |
| pictogrammes | 335 | | |
| ped pour seau à champagne | 293 | | |
| pilon muddler plastique | 307 | | |
| pince à barbecue | 449 | | |
| pince à glaçons | 310 | | |
| pince à salade/pince universelle multi-usages/pince à gâteaux | 438, 445 | | |
| | 448-450 | | |
| pince presse-citron | 391 | | |
| pinçeau pâtissier | 411 | | |
| pique-bons/barre porte-bons | 413 | | |
| planche à découper buffet | 29 | | |
| | 112-113, 136, 144 | | |
| planche à découper PAIN et BUFFET | 170, 221, 222 | | |
| plaque à induction pour chafing dish | 262, 263 | | |
| plaque à pâtisserie | 401, 415, 416 | | |
| plaque chaude | 263 | | |
| plaque pâtissière | 416 | | |
| plaque se'gnalétique avec support/chevalet de table/porte-étiquette | 329-333 | | |
| plat | 128-145 | | |
| plat à tarte | 146-148, 417-420 | | |
| plat ardoise naturelle GN | 118, 119 | | |
| plat buffet | 162 | | |
| plat ceux à poisson/plat banquet | 94, 95, 144 | | |
| plat coquille/casserole à moules | 160 | | |
| plat creux pour la table | 115, 116, 143 | | |
| | 144, 265 | | |
| plat de service | 135, 137, 145 | | |
| plat empilable système catering | 127 | | |
| | 130, 131, 133, 134 | | |
| plat fenille | 27, 90-91 | | |
| plat feuille/plat feuille de palme | 27, 90 | | |
| | 91 | | |
| plat melamin | 25, 30, 31, 36-52, 57-63 | | |
| | 67-70, 73, 77, 79, 82-85 | | |
| plat sushi | 59, 59 | | |
| plateau | 154-159, 388 | | |
| plateau à gâteaux avec pied | 146, 147 | | |
| | 417-419 | | |
| plateau avec cloche | 134, 142 | | |
| plateau avec sucrier et crémier | 386 | | |
| plateau buffet | 129, 135 | | |
| plateau miroir en verre/plateau buffet en verre | 122 | | |
| plateau party | 138, 139 | | |
| plateau self-service et snacks | 155 | | |
| plateau sous-verre | 123 | | |
| poche pâtissière | 414 | | |
| poêle à frire forgée | 400, 401 | | |
| poêle à frire/anses pour la table | 400, 401 | | |
| | 400, 401 | | |
| poêle à frire/plat creux pour la table | 143, 144 | | |
| pompe à vide pour le vin | 320 | | |
| porte verre sà bière | 317 | | |
| porte- bâtonnets de pain (grissini) | 362 | | |
| porte-addition | 153 | | |
| porte-bols | 200, 201 | | |
| porte-bougies anti-vent | 340-342 | | |
| porte-bouteille | 324 | | |
| porte-bouteilles | 317 | | |
| porte-clés avec câble à enroulement | 322 | | |
| porte-étiquette de table avec pince, porte-menu, ou n° de tableetc | 333 | | |
| porte-sachetsw de sucre | 387 | | |
| porte-serviettes | 392, 393 | | |
| portionneur à glace | 443 | | |
| pose-cuillère/égouttoir à couverts/ | | | |
| corbeille à couverts | 167, 174, 197, 278-280 | | |
| pot à lait mini | 234, 235, 385 | | |
| pot en verre avec cuillère | 412 | | |
| poubelle à pédale | 328 | | |
| poubelle de table | 328, 394-398 | | |
| poubelle de table | 394-398 | | |
| présentoir | 87, 88, 125, 180-182 | | |
| présentoir à gâteaux | 142, 146, 147 | | |
| | 417, 418 | | |
| présentoir à gâteaux | 24, 418, 419, | | |
| présentoir à mignardises | 179-184 | | |
| présentoir à sandwiches | 224 | | |
| Présentoir buffet en escalier | 186-189 | | |
| présentoir buffet pour corbeilles | 178 | | |
| | 186-189, 359 | | |
| présentoir buffet réfrigéré/plateau | | | |
| buffet froid | 191, 203, 208, 210 | | |
| présentoir buffet/pied à fruits de mer | 29, 33, 110,145,176, 177 | | |
| présentoir pour station café | 387 | | |
| presse citron | 314 | | |
| presse-agrumes | 314 | | |
| presse-citron/presse citron | 314 | | |
| presse-groseilles | 404 | | |
| presse-groseilles/passoire/chinois | | | |
| renforcé avec maille fine | 402-404 | | |
| protège-menu transparent | 332 | | |
| R | | | |
| rack pour planches à découper | 413 | | |
| rafraichisseur à vin | 290-292, 294-303 | | |
| rafraichisseur CONFÉRENCE | 298 | | |
| rafraichisseur de caviar | 160 | | |
| ramasse-miettes | 398 | | |
| réceptif bain-marie | 404 | | |
| réceptif de table/bol | 45, 47, 51, 53, 55, 59, 61, 65-68, 71 | | |
| | 73-80, 84-86, 89-91 | | |
| repose-couteaux | 389 | | |
| résistance | 245, 251, 262, 263 | | |
| S | | | |
| salière/set sel et poivre | 383, 384 | | |
| saucière | 149 | | |
| saucière thermique | 149 | | |
| saucière/pot à sauce/pot à sauce | | | |
| double paroi | 106, 161, 162 | | |
| saupoudreurs à épices | 383 | | |
| seau à champagne | 294-297 | | |
| seau à glaçons/seau à glaçons | | | |
| isothermique | 303-305 | | |
| seau à vin ou Champagne | 290-302 | | |
| service à parmesan | 376 | | |
| set apéritif | 371-377 | | |
| set de 2 bouchons à vide pour le vin | 320 | | |
| set de 4 tapones | 317 | | |
| set pour le bar/cuillère à cocktail/tamis | | | |
| cocktail/organisateur „bar caddy“ | 308, 311 | | |
| set rolltop | 164, 168-173, 221 | | |
| | 206-215 | | |
| set rolltop/cloche à fromage | 206, 207 | | |
| set sel et poivre | 383, 384 | | |
| sets de tables/chemins de table | 364-369 | | |
| shaker boston | 308, 309 | | |
| snack-holder | 114 | | |
| sonnette | 318 | | |
| soucoupes pose-sachet/présentoir pour sachets de thé | 391 | | |
| spatule | 431-446 | | |
| spatule coudée spéciale grill | 432, 434 | | |
| sucrier | 378, 379 | | |
| sucrier/sucrier doseur | 387 | | |
| support à bretzel ou saucissons/ | | | |
| présentoir à bretzels ou à saucissons | 185 | | |
| support bouteille avec doseur | 318 | | |
| support buffet | 80, 87-88 | | |
| | 186-187 | | |
| | 219, 220 | | |
| support cônes | 420 | | |
| support multiple | 175-177 | | |
| support pour brochettes | 443 | | |
| support pour menu de table | 329-333 | | |
| support pour sucre à flamber | 264 | | |
| supports + étiquettes 10 pc. | 330 | | |
| T | | | |
| tapis de bar | 318 | | |
| tapis de bar/tapis égouttoir pour étagères | 318 | | |
| tasse à café | 102 | | |
| thermobox | 282, 283 | | |
| tire-bouchons sommelier | 312, 313 | | |
| tour de service | 197 | | |
| V | | | |
| vase soliflor | 336 | | |
| verre avec couvercle | 124-127 | | |
| verre mélangeur avec bec verseur | 309 | | |
| verres à moutarde | 373 | | |
| verseuse à huile | 405 | | |
| vide-pomme/évideur à courgette | 427 | | |
| vitrine de buffet | 170, 205 | | |
| | 207-214 | | |
| vitrine de comptoir | 223 | | |
| index item N° | 463-466 | | |

APS



APS Plus – das multifunktionale Mix & Match Buffetsystem
Design by sieger design



Universal

Bowls
S. 18

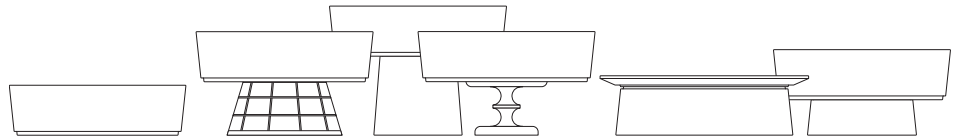

Antipasti

Flat Bowls
S. 22

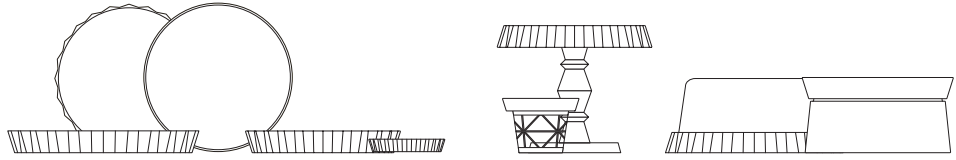

Bakery

Platters & Etagère
S. 24

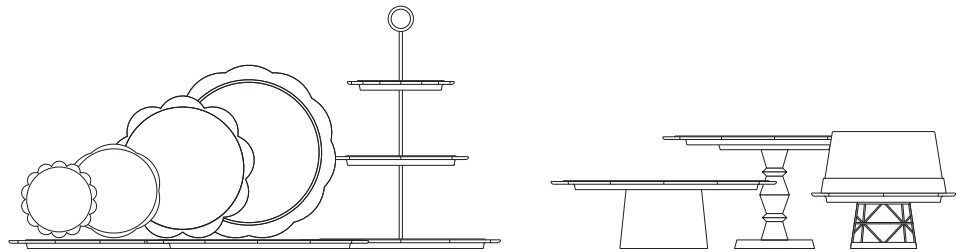

Lotus

Bowls & Platters
S. 26

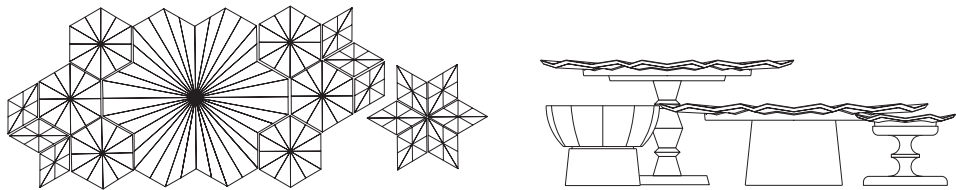

Wood

Platters & Stands
S. 29

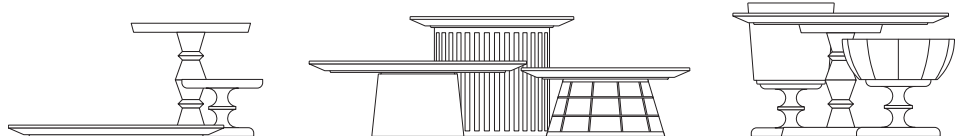

Tiles

Platters & Tray
S. 30



Baskets

Baskets & Riser
S. 32

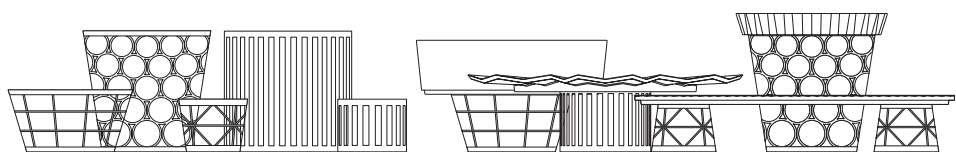

Buffetwelten mit Mehrwert – wunderschön systematisch

APS Plus – Ein System, viele Gesichter

Immer wieder neu, immer wieder anders – APS Plus ermöglicht verschiedene Stilwelten und eröffnet nahezu unendlich viele Möglichkeiten, Speisen zu inszenieren. Dafür lassen sich die einzelnen Teile des Systems multifunktional mit-, in- und aufeinander kombinieren. So kann eine Schale auch Sockel für andere Teile sein, in unterschiedlichen Höhen wird Kulinarisches präsentiert und anschließend praktisch verwahrt. Mit dem Mix an Formen, Materialien und Oberflächen wird auch Fingerfood abwechslungsreich in Szene gesetzt. Damit entspricht das von sieger design gestaltete Buffetsystem den modernen Anforderungen der heutigen Gastronomie.

APS Plus – one system, many faces

Always new, always different – APS Plus enables a variety of styles and opens up almost endless options for presenting your dishes. The individual items in the multifunctional range can be combined with, in and on each other. Bowls can double as bases for other items, culinary creations can be presented at different heights and afterwards it can all be stored practically. The mix of forms, materials and surfaces also allows highly varied presentation of finger food, ensuring that the buffet range designed by sieger design meets the cutting-edge needs of modern gastronomy.

APS Plus – un sistema, muchas caras

Cada vez nuevo, cada vez diferente: APS Plus permite crear diferentes estilos y abre infinitas posibilidades para la puesta en escena de sus platos. Las piezas individuales del sistema se pueden combinar de forma multifuncional. Así, un cuenco puede servir de base para otras piezas, para presentar creaciones culinarias a diferentes alturas y almacenarlas después de una manera muy práctica. La mezcla de formas, materiales y superficies también permite presentar aperitivos de formas muy variadas. De este modo, el sistema de buffet diseñado por Sieger Design responde a las necesidades modernas de la gastronomía actual.

APS Plus – un système, de nombreux visages

Il se renouvelle sans cesse, adoptant des styles divers et offrant d’innombrables possibilités de présenter vos mets. Il vous suffit de jouer sur le caractère multifonctionnel de ses éléments en les combinant, les imbriquant et les emplant. Un récipient peut ainsi devenir le socle d’autres pièces pour une présentation sur différentes hauteurs, puis redevenir un récipient pratique pour son rangement. Le mélange des formes, matériaux et finitions est aussi propice à une présentation variée d’amuse-bouches. Le système signé sieger design répond ainsi aux exigences de la restauration d’aujourd’hui.

Funktionen / functions / fonctions / funciones

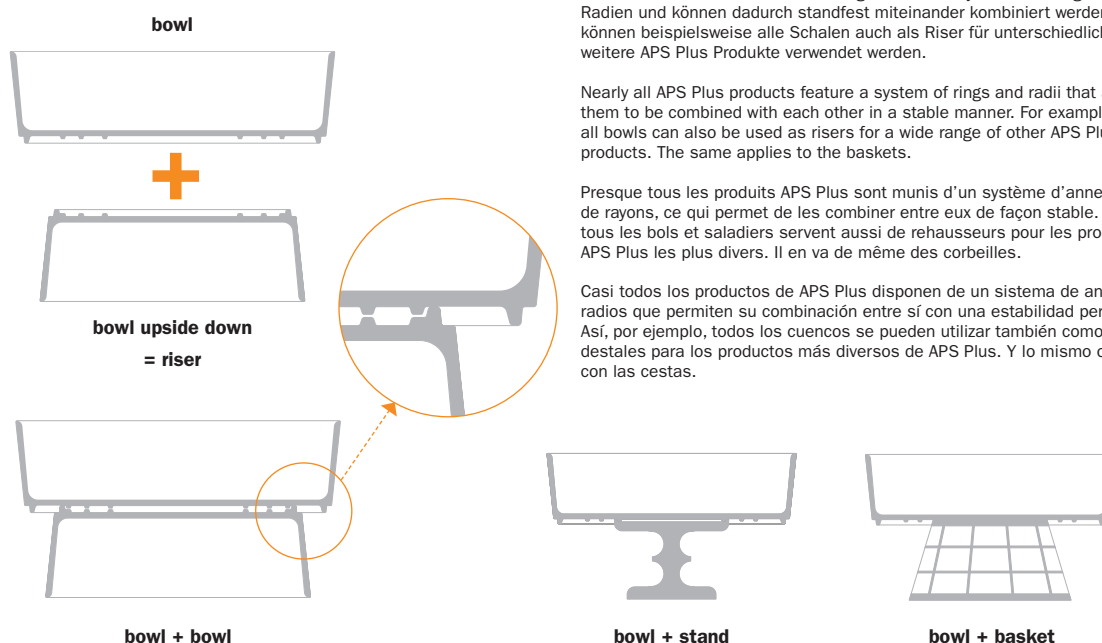

+ Kompatibilität / compatibility / compatibilité / combinación

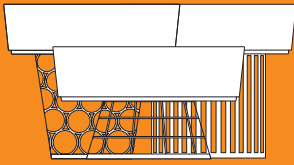

Baskets
risers

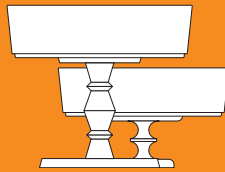

Wood
risers

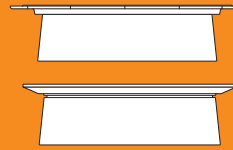

Bakery/Wood
plates

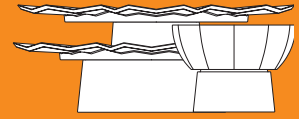

Lotus
bowls/plates



weiß; innen glänzend, außen matt
white; glossy on the inside, matt on the outside
blanc; intérieur brillant, extérieur mat
blanco; interior brillante, exterior mate



Holzdekor Ahorn & Farbe
maple wood decor & colour
aspect érable & couleur
textura de madera arce & color



Holzdekor Eiche dunkel & Farbe
oak wood decor & colour
aspect chêne foncé & couleur
textura de madera roble oscuro

bicolor
bicolour
bicolore
bicolor



bicolor
bicolour
bicolore
bicolor

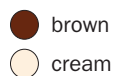

Schale, rund „UNIVERSAL“
bowl, round
cuenco, redondo
bol rond



| | □ cm | ↑ cm | ltr. | |
|---------|--------|------|------|---|
| 15100 0 | Ø 6,5 | 6 | 0,15 | ○ |
| 15101 7 | Ø 9 | 4 | 0,15 | ○ |
| 15102 4 | Ø 13 | 7 | 0,6 | ○ |
| 15103 1 | Ø 16 | 12 | 1,5 | ○ |
| 15104 8 | Ø 16 | 15 | 2,5 | ○ |
| 15105 5 | Ø 20 | 7 | 1,5 | ○ |
| 15106 2 | Ø 24 | 9 | 2,7 | ○ |
| 15107 9 | Ø 26,5 | 9 | 3 | ○ |
| 15108 6 | Ø 32,5 | 9 | 4 | ○ |

Schale, quadratisch „UNIVERSAL“
bowl, square
bol cuadrado
plat creux carré



| | □ cm | ↑ cm | ltr. | |
|---------|-------------|------|------|---|
| 15110 9 | 6,5 x 6,5 | 6 | 0,15 | ○ |
| 15111 6 | 9 x 9 | 4 | 0,15 | ○ |
| 15112 3 | 13 x 13 | 7 | 0,6 | ○ |
| 15113 0 | 20 x 20 | 7 | 1,5 | ○ |
| 15114 7 | 24 x 24 | 9 | 3,5 | ○ |
| 15115 4 | 26,5 x 26,5 | 9 | 4 | ○ |



Schale, rechteckig „UNIVERSAL“
bowl, rectangular
cuenco
plat creux rectangulaire



| | □ cm | ↑ cm | GN | ltr. | |
|---------|-------------|------|-----|------|---|
| 15116 1 | 26,5 x 16,2 | 7 | 1/4 | 1,5 | ○ |
| 15117 8 | 26,5 x 16,2 | 9 | 1/4 | 2,5 | ○ |



15210



15230

Schale, rund „UNIVERSAL“
bowl, round
cuenco, redondo
bol rond



Holzdekor Ahorn & Farbe
 maple wood decor & colour
 aspect érable & couleur
 textura de madera arce & color

| | ☐ cm | ↑ cm | litr. | |
|---------|--------|------|-------|-----|
| 15210 6 | Ø 13 | 7 | 0,6 | ● ○ |
| 15211 3 | Ø 20 | 7 | 1,5 | ● ○ |
| 15212 0 | Ø 24 | 9 | 2,7 | ● ○ |
| 15213 7 | Ø 26,5 | 9 | 3 | ● ○ |
| 15214 4 | Ø 32,5 | 9 | 4 | ● ○ |
| 15230 4 | Ø 20 | 7 | 1,5 | ● ● |
| 15231 1 | Ø 32,5 | 9 | 4 | ● ● |

Schale, quadratisch „UNIVERSAL“
bowl, square
bol cuadrado
plat creux carré



Holzdekor Eiche dunkel & Farbe
 oak wood decor & colour
 aspect chêne francé couleur
 textura de madera roble oscuro & color



15216



15233

| | ☐ cm | ↑ cm | litr. | |
|---------|-------------|------|-------|-----|
| 15215 1 | 13 x 13 | 7 | 0,6 | ● ○ |
| 15216 8 | 20 x 20 | 7 | 1,5 | ● ○ |
| 15217 5 | 24 x 24 | 9 | 3,5 | ● ○ |
| 15218 2 | 26,5 x 26,5 | 9 | 4 | ● ○ |
| 15232 8 | 20 x 20 | 7 | 1,5 | ● ● |
| 15233 5 | 26,5 x 26,5 | 9 | 4 | ● ● |

Schale, rechteckig „UNIVERSAL“
bowl, rectangular
cuenco
plat creux rectangulaire



Holzdekor Eiche dunkel & Farbe
 oak wood decor & colour
 aspect chêne francé couleur
 textura de madera roble oscuro & color

GN 1/4
 2 Höhen / 2 heights



15219



15234

| | ☐ cm | ↑ cm | GN | litr. | |
|---------|-------------|------|-----|-------|-----|
| 15219 9 | 26,5 x 16,2 | 7 | 1/4 | 1,5 | ● ○ |
| 15220 5 | 26,5 x 16,2 | 9 | 1/4 | 2,5 | ● ○ |
| 15234 2 | 26,5 x 16,2 | 7 | 1/4 | 1,5 | ● ● |
| 15235 9 | 26,5 x 16,2 | 9 | 1/4 | 2,5 | ● ● |



15235

**Schale „UNIVERSAL“
bowl
cuenco
bol**



15200



15204



15201



15205



15203

| Round | cm | ↑ cm | litr. | |
|---------|-------|------|-------|-----|
| 15200 7 | Ø 6,5 | 6 | 0,15 | ● ○ |
| 15201 4 | Ø 9 | 4 | 0,15 | ● ○ |
| 15202 1 | Ø 16 | 12 | 1,5 | ● ○ |
| 15203 8 | Ø 16 | 15 | 2,5 | ● ○ |

| Square | cm | ↑ cm | litr. | |
|---------|-----------|------|-------|-----|
| 15204 5 | 6,5 x 6,5 | 6 | 0,15 | ● ○ |
| 15205 2 | 9 x 9 | 4 | 0,15 | ● ○ |

**Deckel „UNIVERSAL“
cover
tapa
couvercle seul**



glasklar, mit Löffelaussparung
transparent, with notched for spoons
transparent, avec encoche pour la cuillère
Plástico, con espacio para oja cuchara



15340-15344



15345-15347



15348

| Round | cm | ↑ cm | |
|---------|--------|------|---------------|
| 15340 0 | Ø 16 | 1,5 | ○ transparent |
| 15341 7 | Ø 20 | 1,5 | ○ transparent |
| 15342 4 | Ø 24 | 1,5 | ○ transparent |
| 15343 1 | Ø 26,5 | 1,5 | ○ transparent |
| 15344 8 | Ø 32,5 | 1,5 | ○ transparent |

| Square | cm | ↑ cm | |
|---------|-------------|------|---------------|
| 15345 5 | 20 x 20 | 1,5 | ○ transparent |
| 15346 2 | 24 x 24 | 1,5 | ○ transparent |
| 15347 9 | 26,5 x 26,5 | 1,5 | ○ transparent |

| Rectangular | cm | ↑ cm | GN | |
|-------------|-------------|------|-----|---------------|
| 15348 6 | 26,5 x 16,2 | 1,5 | 1/4 | ○ transparent |



15205

+ Kompatibilität / compatibility / compatibilité / combinación

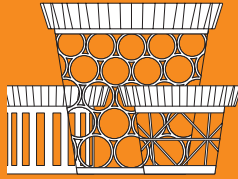

Baskets
risers

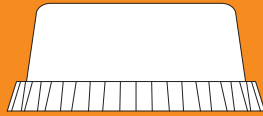

Cover
seal

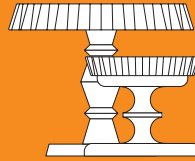

Wood
risers

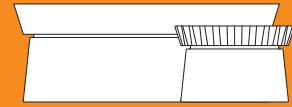

Bowls
risers



15140



15141



15142

Schale „PLISSEE“
bowl
cuenco
bol



| | cm | cm | |
|---------|--------|-----|---|
| 15140 6 | Ø 14,5 | 2,5 | ○ |
| 15141 3 | Ø 25 | 3,5 | ○ |
| 15142 0 | Ø 35 | 4 | ○ |



**Schale
bowl
cuenco
bol**



| | ☐ cm | ↑ cm | |
|---------|--------|------|---|
| 15135 2 | Ø 14,5 | 2,5 | ○ |
| 15136 9 | Ø 25 | 3,5 | ○ |
| 15137 6 | Ø 35 | 4 | ○ |

3 Größen / 3 sizes



15136



15137



15270

3 Größen / 3 sizes

**Schale
bowl
cuenco
bol**



Holzdekor Ahorn & Farbe
maple wood decor & colour
aspect érable & couleur
textura de madera arce & color

| | ☐ cm | ↑ cm | |
|---------|--------|------|-----|
| 15270 0 | Ø 14,5 | 2,5 | ● ○ |
| 15271 7 | Ø 25 | 3,5 | ● ○ |
| 15272 4 | Ø 35 | 4 | ● ○ |



15271



3mm Materialstärke

**Frischhalte-Haube
cover
campana
cloche bombée**



glasklar, Griff verchromt
transparent, chrome knob
transparent, asa cromada
transparente, ansa cromée

| | ☐ cm | ↑ cm | matches |
|---------|--------|------|-------------------------|
| 15351 6 | Ø 20,5 | 10 | 15141 15136 15271 |
| 06512 3 | Ø 30 | 11,5 | 15142 15137 15272 |



15351



06512

+ Kompatibilität / compatibility / compatibilit  / combinaci n

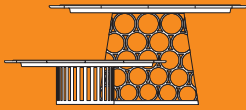

Baskets
risers

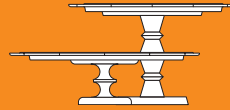

Wood
risers

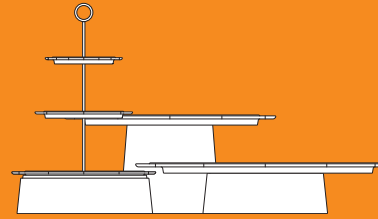

Universal
risers



**Tablett „BAKERY“
tray
bandeja
plateau**



| | □ cm | ↑ cm | |
|---------|--------|------|---|
| 15130 7 | Ø 18,5 | 1,5 | ○ |
| 15131 4 | Ø 23,5 | 1,5 | ○ |
| 15132 1 | Ø 35 | 1,5 | ○ |
| 15133 8 | Ø 42,5 | 1,5 | ○ |



15132
15133

**Etagère „BAKERY“
etagère
estante
presentoir**



| | □ cm | ↑ cm | |
|---------|----------------|------|---|
| 15160 4 | Ø 35/23,5/18,5 | 40 | ○ |



3mm Materialstärke



15350,
15351

**Frischhalte-Haube
cover
campana
cloche bombée**



glasklar, Griff verchromt
transparent, chrome
transparent, asa cromada
transparente, ansa cromée

| | □ cm | ↑ cm | matches | |
|---------|--------|------|---------|---------------|
| 15350 9 | Ø 16,5 | 10 | 15130 | ○ transparent |
| 15351 6 | Ø 20,5 | 10 | 15131 | ○ transparent |
| 06512 3 | Ø 30 | 11,5 | 15132 | ○ transparent |
| 06517 8 | Ø 33 | 12,5 | 15133 | ○ transparent |

Rolltop Cover

| | | | | |
|---------|------|----|-------|---------------|
| 18388 9 | Ø 38 | 20 | 15133 | ○ transparent |
|---------|------|----|-------|---------------|



15133



06517

15133

+ Kompatibilität / compatibility / compatibilité / combinación

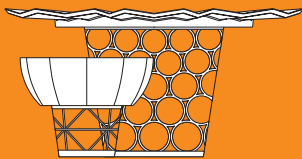

Baskets
risers

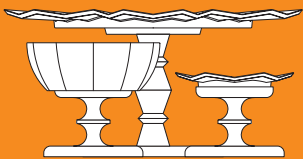

Wood
risers

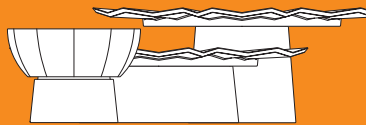

Universal
risers





○ 15152

Blattschale large „LOTUS“
leaf large
fuelle en forma de hoja
plat feuille



| | ☐ cm | ↑ cm | |
|---------|--------|------|--------------|
| 15152 9 | ∅ 46,5 | 2,5 | ○ white |
| 15257 1 | ∅ 46,5 | 2,5 | ● green |
| 15263 2 | ∅ 46,5 | 2,5 | ● dark green |



● 15267



● 15263



○ 15151

Blattschale medium „LOTUS“
leaf medium
fuelle en forma de hoja
plat feuille



| | ☐ cm | ↑ cm | |
|---------|--------|------|----------------|
| 15151 2 | ∅ 17,5 | 2,5 | ○ white |
| 15259 5 | ∅ 17,5 | 2,5 | ● yellow green |
| 15256 4 | ∅ 17,5 | 2,5 | ● green |
| 15262 5 | ∅ 17,5 | 2,5 | ● dark green |



● 15259



● 15256



● 15262



○ 15150

Blattschale small „LOTUS“
leaf medium
fuelle en forma de hoja
plat feuille



| | ☐ cm | ↑ cm | |
|---------|----------|------|----------------|
| 15150 5 | 15 x 8,5 | 2,5 | ○ white |
| 15258 8 | 15 x 8,5 | 2,5 | ● yellow green |
| 15255 7 | 15 x 8,5 | 2,5 | ● green |
| 15261 8 | 15 x 8,5 | 2,5 | ● dark green |

● 15261



● 15255

● 15258

○ 15150

Schale Water Lily „LOTUS“
leaf
fuente en forma de hoja
plat feuille



| | ▣ cm | ↑ cm | ltr. | |
|---------|-------|------|------|---|
| 15165 9 | Ø 8,5 | 4 | 0,1 | ○ |
| 15166 6 | Ø 13 | 6 | 0,3 | ○ |
| 15167 3 | Ø 20 | 7 | 1,25 | ○ |



15165
0,1 ltr.



15166
0,3 ltr.



15167
1,25 ltr.

Schale Water Lily „LOTUS“
leaf
fuente en forma de hoja
plat feuille



| | ▣ cm | ↑ cm | ltr. | |
|---------|-------|------|------|----|
| 15206 9 | Ø 8,5 | 4 | 0,1 | ●○ |
| 15207 6 | Ø 13 | 6 | 0,3 | ●○ |
| 15208 3 | Ø 20 | 7 | 1,25 | ●○ |



15206
0,1 ltr.



15207
0,3 ltr.



15208
1,25 ltr.

+ Kompatibilität / compatibility / compatibilité / combinación



Universal
bowls

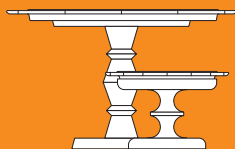

Tiles
plates

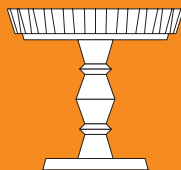

Antipasti
flat bowls



Lotus
plates/bowls

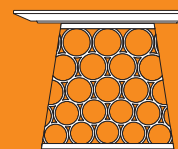

Baskets
risers



Tablett „WOOD“
tray
bandeja
plateau



- Eiche dunkel oder ● Ahorn
- oak or ● maple
- chêne foncé ou ● érable
- Roble oscuro o ● Arce

| | cm | cm | ↑ cm | matches |
|---------|--------|----|------|-------------------|
| 15300 4 | Ø 30 | 2 | ● | all stands, bowls |
| 15301 1 | Ø 30 | 2 | ● | all stands, bowls |
| 15302 8 | Ø 38,5 | 2 | ● | all stands, bowls |
| 15303 5 | Ø 38,5 | 2 | ● | all stands, bowls |



● 15312



● 15311

Ständer „WOOD“
stand
soporte
support



- Eiche dunkel oder ● Ahorn
- oak or ● maple
- chêne foncé ou ● érable
- Roble oscuro o ● Arce

| | cm | cm | ↑ cm | matches |
|---------|-----------|------|------|-------------------|
| 15310 3 | Ø 15/11,5 | 10,5 | ● | all plates, bowls |
| 15311 0 | Ø 15/11,5 | 10,5 | ● | all plates, bowls |
| 15312 7 | Ø 21/15 | 20 | ● | all plates, bowls |
| 15313 4 | Ø 21/15 | 20 | ● | all plates, bowls |



06517

15303

15313

Rolltop Cover
18388



Frischhalte-Haube
cover
campana
cloche



glasklar
clear
transparente
transparente

| | cm | cm | matches |
|---------|------|------|--------------|
| 06517 8 | Ø 33 | 12,5 | 15302, 15303 |
| 18388 9 | Ø 38 | 20 | 15302, 15303 |

+ Kompatibilität / compatibility / compatibilit  / combinaci n

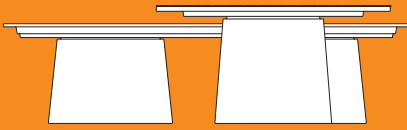

Bowls
risers

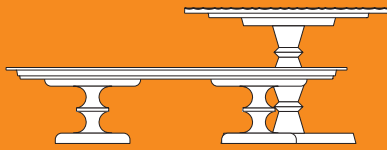

Wood
risers

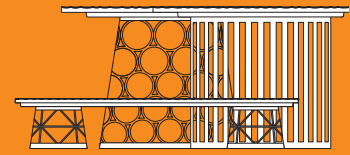

Baskets
risers



Tablett „TILES“
tray
bandeja
plat



| | ▣ cm | ↑ cm | GN | |
|---------|-----------|------|-----|---------|
| 15120 8 | 53 x 32,5 | 2 | 1/1 | ○ white |
| 15236 6 | 53 x 32,5 | 2 | 1/1 | ● black |

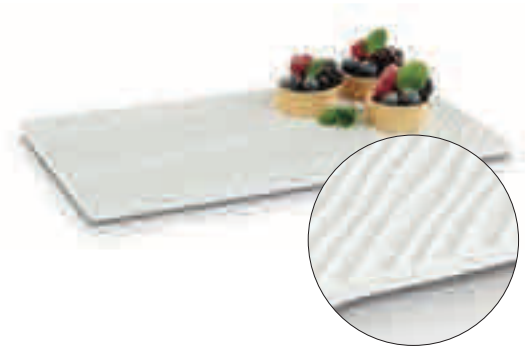

Tablett „TILES“
tray
bandeja
plat



weiß / white / blanc / blanco

| | ☐ cm | ↑ cm | GN | |
|---------|-------------|------|-----|---|
| 15125 3 | 26,5 x 16,2 | 1,5 | 1/4 | ○ |
| 15126 0 | 35,5 x 17,6 | 1,5 | 1/3 | ○ |
| 15128 4 | 32,5 x 26,5 | 1,5 | 1/2 | ○ |
| 15127 7 | 53 x 16,2 | 1,5 | 2/4 | ○ |



Tablett „TILES“
tray
bandeja
plat



schwarz / black / noir / negro

| | ☐ cm | ↑ cm | GN | |
|---------|-------------|------|-----|---|
| 15250 2 | 26,5 x 16,2 | 1,5 | 1/4 | ● |
| 15251 9 | 32,5 x 17,5 | 1,5 | 1/3 | ● |
| 15253 3 | 32,5 x 26,5 | 1,5 | 1/2 | ● |
| 15252 6 | 53,0 x 16,2 | 1,5 | 2/4 | ● |

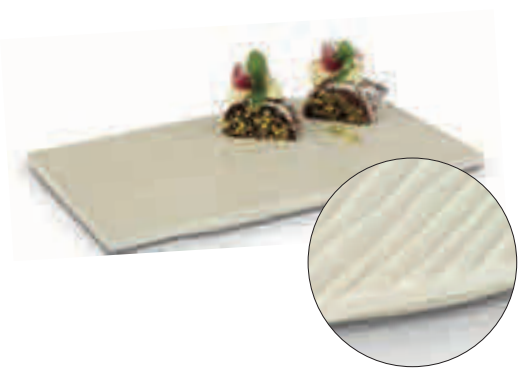

Tablett „TILES“
tray
bandeja
plat



Holzdekor Ahorn / maple wood decor / aspect érable / textura de madera arce

| | ☐ cm | ↑ cm | GN | |
|---------|-------------|------|-----|---|
| 15221 2 | 26,5 x 16,2 | 1,5 | 1/4 | ● |
| 15222 9 | 32,5 x 17,6 | 1,5 | 1/3 | ● |
| 15224 3 | 32,5 x 26,5 | 1,5 | 1/2 | ● |
| 15223 6 | 53 x 16,2 | 1,5 | 2/4 | ● |

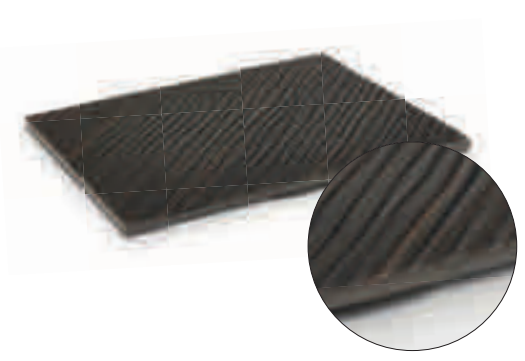

Tablett „TILES“
tray
bandeja
plat



Holzdekor Eiche dunkel / oak wood decor / aspect chêne foncé / textura de madera

| | ☐ cm | ↑ cm | GN | |
|---------|-------------|------|-----|---|
| 15225 0 | 26,5 x 16,2 | 1,5 | 1/4 | ● |
| 15226 7 | 32,5 x 17,5 | 1,5 | 1/3 | ● |
| 15228 1 | 32,5 x 26,5 | 1,5 | 1/2 | ● |
| 15227 4 | 53,0 x 16,2 | 1,5 | 2/4 | ● |

+ Kompatibilität / compatibility / compatibilité / combinación

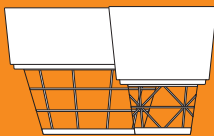

Universal
bowls

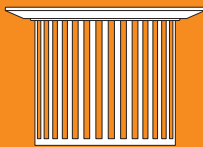

Wood
plates

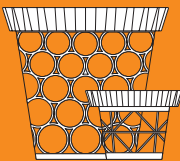

Antipasti
flat bowls

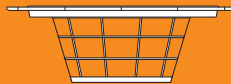

Tiles
plates

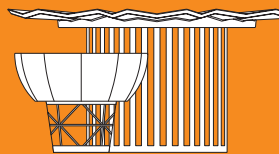

Lotus
plates/bowls





Korb/Ständer
basket/riser
cestas/soporte
corbeilles/support



schwarz / black / noir / negro

| | ☐ cm | ↑ cm | |
|---------|---------|------|---------|
| 15326 4 | Ø 21/15 | 21 | ● black |

15326 15326



Korb/Ständer
basket/riser
cestas/soporte
corbeilles/support



Metall / metal / métal / metálico

| | ☐ cm | ↑ cm | |
|---------|---------|------|----------------|
| 15321 9 | Ø 21/15 | 11 | ● chrome |
| 15325 7 | Ø 21/15 | 11 | ● gold brushed |
| 15323 3 | Ø 21/15 | 11 | ● copper |

15321 15325 15323



Korb/Ständer
basket/riser
cestas/soporte
corbeilles/support



Metall / metal / métal / metálico

| | ☐ cm | ↑ cm | |
|---------|----------|------|----------------|
| 15320 2 | Ø 10,5/8 | 8 | ● chrome |
| 15324 0 | Ø 10,5/8 | 8 | ● gold brushed |
| 15322 6 | Ø 10,5/8 | 8 | ● copper |

15322 15320 15324



Korb/Ständer
basket/riser
cestas/soporte
corbeilles/support



Chrom poliert / polished chrome / chrome poli / color plata brillante

| | ☐ cm | ↑ cm | |
|---------|------|------|----------|
| 15331 8 | Ø 15 | 10,5 | ● chrome |
| 15332 5 | Ø 21 | 20 | ● chrome |

15332 15331



Korb/Ständer
basket/riser
cestas/soporte
corbeilles/support



Gold, gebürstet / brushed gold / doré brossé / dorado cepillado

| | ☐ cm | ↑ cm | |
|---------|------|------|----------------|
| 15334 9 | Ø 15 | 10,5 | ● gold brushed |
| 15335 6 | Ø 21 | 20 | ● gold brushed |

15335 15334



Servierartikel aus Melamin
serving items melamine
artículos de servicio en melamina
pièces de service en mélamine

OAK LIGHT



NEW

Tablett „OAK LIGHT“
tray
bandeja
plateau



die Melaminplatten (Holzoptik Eiche) haben eine leichte Struktur und wirken optisch wie aus Holz gefertigt

superb oak wood effect, cutting edge gourmet presentation idea, never produce mould or sawdust, clean and hygienic, no more worries about crack

melamina imitación madera de roble, para recetas auténticas

mélamine imitation chêne, pour vos recettes authentiques



84262
Ø 35 cm



84263
Ø 44 cm



84264



84265

| | □ cm | ↑ cm |
|---------|---------|------|
| 84262 5 | Ø 35 | 3 |
| 84263 2 | Ø 44 | 3 |
| 84264 9 | 44 x 25 | 1,5 |
| 84265 6 | 65 x 26 | 3 |

Tablett „OAK LIGHT“
tray
bandeja
plateau



die Melaminplatten (Eiche-Holzoptik) haben eine leicht wellige Oberfläche und wirken optisch wie aus Holz gefertigt

imagine the durability of melamine and the beauty of oak-wood - fantastic imitation of wood
 melamina imitación madera: madera con la durabilidad de la melamina gracias a la superficie ligeramente irregular de la melamina

mélamine imitation bois: toute bois mais avec la durabilité de la mélamine, la surface irrégulière renforce l'aspect naturel

| | ☐ cm | ↑ cm | GN |
|---------|-------------|------|-----|
| 84205 2 | 53,0 x 32,5 | 1,5 | 1/1 |
| 84206 9 | 32,5 x 26,5 | 1,5 | 1/2 |
| 84207 6 | 32,5 x 17,6 | 1,5 | 1/3 |
| 84208 3 | 26,5 x 16,2 | 1,5 | 1/4 |
| 84209 0 | 53,0 x 16,2 | 1,5 | 2/4 |

Gastronorm - Außenmaße

Gastronorm - size

Gastronorm - medidas exteriores

Gastronorme - Diensions extérieures



GN1/2
84206

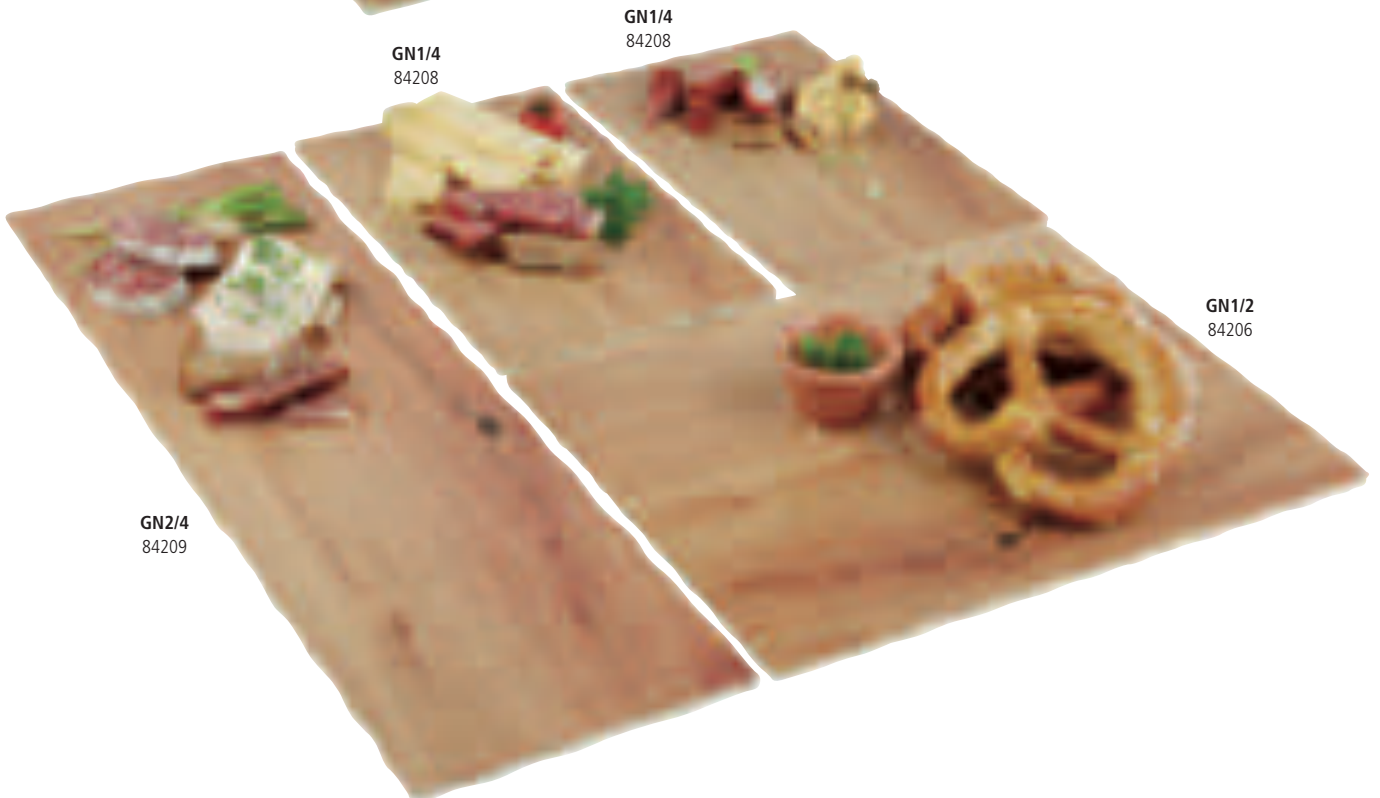

GN1/4
84208

GN1/4
84208

GN1/2
84206

GN2/4
84209



Platte „TIMBER“
plate
bandeja
plateau



die Melaminplatten (Holzoptik Fichte) haben eine leichte Struktur und wirken optisch wie aus Holz gefertigt

superb spruce wood effect (timber), cutting edge gourmet presentation idea, never produce mould or sawdust, clean and hygienic, no more worries about crack

melamina imitación madera de picea, para recetas auténticas

mélamine imitation spruce, pour vos recettes authentiques



Ø 35 cm
 Ø 44 cm

| | □ cm | ↑ cm |
|---------|---------|------|
| 84266 3 | Ø 35 | 3 |
| 84267 0 | Ø 44 | 3 |
| 84268 7 | 44 x 25 | 1,5 |
| 84269 4 | 65 x 26 | 3 |



84268



84269



OAK



Tablett „OAK“
tray
bandeja
plateau



84177

die Melaminplatten (Holzoptik Eiche) haben eine leichte Struktur und wirken optisch wie aus Holz gefertigt

superb oak wood effect, cutting edge gourmet presentation idea, never produce mould or sawdust, clean and hygienic, no more worries about crack

melamina imitación madera de roble, para recetas auténticas

mélamine imitation chêne, pour vos recettes authentiques

| | □ cm | ↑ cm | Grifflänge / handle cm |
|---------|---------|------|------------------------|
| 84177 2 | Ø 30 | 1,5 | 12 |
| 84178 9 | 40 x 20 | 1,5 | 13 |
| 84179 6 | 48 x 20 | 1,5 | 13 |



84178



84179

Holzoptik



Gastronorm - Außenmaße
Gastronorm - size
Gastronorm - medidas exteriores
Gastronorme - Diensions extérieures

Tablett „DRIFTWOOD“
tray
bandeja
plateau



die Melaminplatten (Holzoptik) haben eine leicht wellige Oberfläche und wirken optisch wie aus Holz gefertigt

imagine the durability of melamine and the beauty of wood - fantastic imitation of wood

melamina imitación madera: madera con la durabilidad de la melamina gracias a la superficie ligeramente irregular de la melamina.

mélamine imitation bois: toute bois mais avec la durabilité de la mélamine, la surface irrégulière renforce l'aspect naturel

| | ☐ cm | ↑ cm | GN |
|---------|-------------|------|-----|
| 84180 2 | 53,0 x 32,5 | 1,5 | 1/1 |
| 84181 9 | 32,5 x 26,5 | 1,5 | 1/2 |
| 84182 6 | 32,5 x 17,6 | 1,5 | 1/3 |
| 84183 3 | 26,5 x 16,2 | 1,5 | 1/4 |
| 84184 0 | 53,0 x 16,2 | 1,5 | 2/4 |



GN1/3
84182

Granitoptik



Gastronorm - Außenmaße
Gastronorm - size
Gastronorm - medidas exteriores
Gastronorme - Diensions extérieures

Tablett „GRANIT“
tray
bandeja
plateau



die Melaminplatten (Granitoptik) haben eine leicht wellige Oberfläche und wirken optisch wie der Naturstein Granit

fantastic imitation of granit stone

Melamina: excelente imitación del granito natural con el acabado irregular de la superficie de la melamina.

Mélamine imitation granit naturel. La surface irrégulière renforce l'aspect de la pierre naturelle.

| | ☐ cm | ↑ cm | GN |
|---------|-------------|------|-----|
| 84190 1 | 53,0 x 32,5 | 1,5 | 1/1 |
| 84191 8 | 32,5 x 26,5 | 1,5 | 1/2 |
| 84192 5 | 32,5 x 17,6 | 1,5 | 1/3 |
| 84193 2 | 26,5 x 16,2 | 1,5 | 1/4 |
| 84194 9 | 53,0 x 16,2 | 1,5 | 2/4 |



GN1/4
84193

ZERO



Gastronorm - Außenmaße
Gastronorm - size
Gastronorm - medidas exteriores
Gastronorme - Diensions extérieures

Tablett „ZERO“
tray
bandeja
plat



| | ▣ cm | ↑ cm | GN | |
|---------|-------------|------|-----|---|
| 84185 7 | 53,0 x 32,5 | 1,5 | 1/1 | ○ |
| 84186 4 | 32,5 x 26,5 | 1,5 | 1/2 | ○ |
| 84187 1 | 32,5 x 17,6 | 1,5 | 1/3 | ○ |
| 84188 8 | 26,5 x 16,2 | 1,5 | 1/4 | ○ |
| 84189 5 | 53,0 x 16,2 | 1,5 | 2/4 | ○ |
| 84195 6 | 53,0 x 32,5 | 1,5 | 1/1 | ● |
| 84196 3 | 32,5 x 26,5 | 1,5 | 1/2 | ● |
| 84197 0 | 32,5 x 17,6 | 1,5 | 1/3 | ● |
| 84198 7 | 26,5 x 16,2 | 1,5 | 1/4 | ● |
| 84199 4 | 53,0 x 16,2 | 1,5 | 2/4 | ● |



glatte Oberfläche
smooth surface

mit Antirutsch-Füßchen
non-slip feet
con pies antideslizantes
avec pieds anti-dérapants

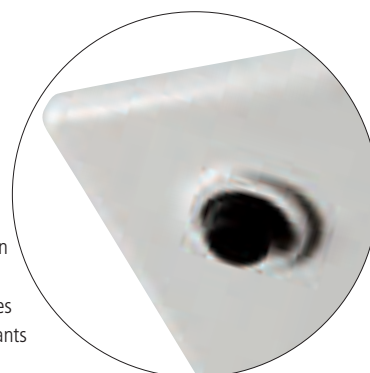



84312



84314



84217

Schale „FULLIES“ bowl bol plat



| | □ cm | ↑ cm | ltr. | |
|---------|------|------|------|----------------|
| 84312 7 | Ø 8 | 4 | 0,1 | ● white/mint |
| 84314 1 | Ø 8 | 4 | 0,1 | ● white/yellow |
| 84217 5 | Ø 8 | 4 | 0,1 | ● black/white |



84315



84317



84218

Schale „FULLIES“ bowl bol plat



| | □ cm | ↑ cm | ltr. | |
|---------|-------|------|------|----------------|
| 84315 8 | Ø 8,5 | 3,5 | 0,05 | ● white/mint |
| 84317 2 | Ø 8,5 | 3,5 | 0,05 | ● white/yellow |
| 84218 2 | Ø 8,5 | 3,5 | 0,05 | ● black/white |



Tablett „SLATE“
tray
bandeja
plat



| | cm | ↑ cm | Grifflänge (cm) | Loch (cm) |
|---------|--------|------|-----------------|-----------|
| 84240 3 | Ø 18,5 | 1,5 | 8,5 | 1,5 |
| 84241 0 | Ø 23 | 1,5 | 10 | 2 |
| 84242 7 | Ø 34 | 1,5 | 14 | 2,5 |
| 84243 4 | Ø 37 | 1,5 | 15,5 | 3 |



passende Hauben / covers
15350, 15351

Zubehör / spare parts / recambios / pièces de rechange



Haube / cover / campana / cloche

| | cm | ↑ cm | matches |
|---------|--------|------|---------|
| 15350 9 | Ø 16,5 | 10 | 84240 |
| 15351 6 | Ø 20,5 | 10 | 84241 |
| 06512 3 | Ø 30 | 11,5 | 84242 |
| 06517 8 | Ø 33 | 12,5 | 84243 |

passende Hauben / covers
06512, 80657



passende Tablett / trays
84240, 84241



passende Tablett / trays
84242, 84243

SLATE



Die schwarzen Melaminplatten überzeugen mit ihrem edlen und schlichten Schieferlook.

Fantastic imitation of slate. This plates add a rustic feel to your display. Perfect Presentation for cheese, chocolates, pastry and meat.

Las bandejas de melamina negras ofrecen un aspecto de pizarra elegante y discreto.

Les plats en mélamine noire offrent l'aspect de l'ardoise, élégants et discrets.

NEW

Tablett „SLATE“ tray bandeja plat



mit Antirutsch-Füßchen

| | cm | cm |
|---------|------|----|
| 83992 2 | Ø 30 | 1 |
| 83994 6 | Ø 40 | 1 |



Ø 30 cm



Ø 40 cm

mit Antirutsch-Füßchen
non-slip feet
con pies antideslizantes
pieds anti-dérapants

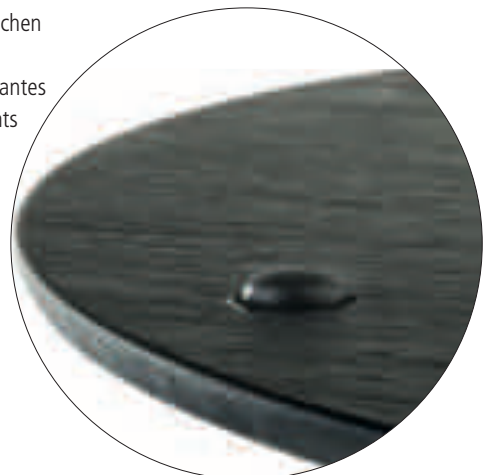



GN 1/1

GN-Tablett „SLATE“
tray
bandeja
plat



| | cm | ↑ cm | GN |
|---------|-------------|------|-----|
| 83981 6 | 53,0 x 32,5 | 1,5 | 1/1 |

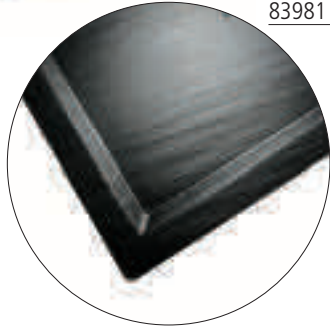

Schieferoptik



Gastronorm-Maße
gastronorm-sizes

Tablett „SLATE“
tray
bandeja
plat



| | cm | ↑ cm | GN |
|---------|-------------|------|-----|
| 83955 7 | 53,0 x 32,5 | 1 | 1/1 |
| 83956 4 | 32,5 x 26,5 | 1 | 1/2 |
| 83957 1 | 32,5 x 17,5 | 1 | 1/3 |
| 83958 8 | 26,5 x 16,2 | 1 | 1/4 |
| 83971 7 | 53,0 x 16,2 | 1 | 2/4 |



4 cm

Tablett „SLATE HOCHSTAPLER“
tray
bandeja
plat empilable système catering



massive Metallgriffe verchromt inkl. fest verschraubten 4 cm Distanzstücken
chrome plated handles, incl. mounted 4 cm distance pillars
asas cromadas, incluye distanciadores a 4 cm
poignées chromées, distance approx. 4 cm



GN 1/1

| | cm | ↑ cm | GN |
|---------|-------------|------|-----|
| 83980 9 | 53,0 x 32,5 | 6 | 1/1 |

Schieferoptik



Schale „SLATE“
bowl
cuenco
bol



| | cm | ↑ cm | ltr. |
|---------|-------------|------|------|
| 84245 8 | 25,0 x 25,0 | 12 | 3,8 |



Das Wechselspiel zwischen den hoch glänzenden Innenflächen und dem matten Rand bilden einen stilvollen Rahmen für die Präsentation Ihrer Speisen. Der breite Rand sorgt dabei für ein optimales und unkompliziertes Handling im täglichen Einsatz. Die in den Farben Weiss und Terrakotta erhältlichen Artikel eignen sich gleichermaßen für die Speisenpräsentation auf dem Tisch, in der Theke oder auf dem Buffet.

The interplay between mirror shiny insides and matt finished edges is the base for a stylish presentation of your food. An optimally and uncomplicated handling due to the wide edge in your daily use is guaranteed.

The articles are available in white and terracotta colored. They are similarly suitable for the food presentation for table top, countertop or buffet setting.

El contraste entre el exterior y bordes an acabado mate y el interior brillante da un toque elegante y de calidad a sus presentaciones culinarias.

La colección se declina en 2 colores: arcilla y blanco. La colección es perfecta tanto para la mesa como para el mostrador, las vitrinas o el buffet.

Style et élégance : La finition mate de l'extérieur et des rebords offre un élégant contraste avec l'intérieur brillant des différentes pièces de la collection qui se décline en deux couleurs : blanc et argile. La gamme s'adapte parfaitement pour le service de table, comme pour le comptoir ou le buffet.



GN 1/1
GN 1/2

Tablett „TIERRA“
tray
bandeja
plateau



| | ▣ cm | ↑ cm | GN | |
|---------|-------------|------|-----|---|
| 84270 0 | 53,0 x 32,5 | 2,5 | 1/1 | ● |
| 84271 7 | 32,5 x 26,5 | 2,5 | 1/2 | ● |
| 84280 9 | 53,0 x 32,5 | 2,5 | 1/1 | ○ |
| 84281 6 | 32,5 x 26,5 | 2,5 | 1/2 | ○ |



GN 2/4

Tablett „TIERRA“
tray
bandeja
plateau



| | ▣ cm | ↑ cm | GN | |
|---------|-------------|------|-----|---|
| 84272 4 | 53,0 x 16,2 | 2,5 | 2/4 | ● |
| 84282 3 | 53,0 x 16,2 | 2,5 | 2/4 | ○ |



oval

Schale, oval „TIERRA“
bowl, oval
cuenco, ovalada
bol, ovale



| | ▣ cm | ↑ cm | | |
|---------|---------|------|--|---|
| 84275 5 | 40 x 20 | 2,5 | | ● |
| 84285 4 | 40 x 20 | 2,5 | | ○ |



1 Liter und 2,5 Liter

Schale „TIERRA“
bowl
cuenco
bol



| | ▣ cm | ↑ cm | ltr. | |
|---------|---------|------|------|---|
| 84273 1 | 19 x 19 | 8 | 1 | ● |
| 84274 8 | 25 x 25 | 10 | 2,5 | ● |
| 84283 0 | 19 x 19 | 8 | 1 | ○ |
| 84284 7 | 25 x 25 | 10 | 2,5 | ○ |



Ø 32 cm und
Ø 40,5 cm

Teller „TIERRA“
tray
bandera
plateau



| | ▣ cm | ↑ cm | | |
|---------|--------|------|--|---|
| 84276 2 | Ø 32,0 | 3,5 | | ● |
| 84277 9 | Ø 40,5 | 5,5 | | ● |
| 84286 1 | Ø 32,0 | 3,5 | | ○ |
| 84287 8 | Ø 40,5 | 5,5 | | ○ |

Schale „TIERRA“
bowl
cuenco
bol



| | □ cm | ↑ cm | litr. | |
|---------|------|------|-------|---|
| 84290 8 | Ø 10 | 7 | 0,13 | ● |
| 84295 3 | Ø 10 | 7 | 0,13 | ○ |

Teller „TIERRA“
tray
bandeja
plateau



| | □ cm | ↑ cm | litr. | |
|---------|--------|------|-------|---|
| 84291 5 | Ø 13,5 | 3 | 0,13 | ● |
| 84296 0 | Ø 13,5 | 3 | 0,13 | ○ |

Tablett „TIERRA“
tray
bandeja
plateau



oval flach

| | □ cm | ↑ cm | |
|---------|-------------|------|---|
| 84292 2 | 21,5 x 10,5 | 1,5 | ● |
| 84297 7 | 21,5 x 10,5 | 1,5 | ○ |

Schale „TIERRA“
bowl
cuenco
bol



oval hoch

| | □ cm | ↑ cm | litr. | |
|---------|------------|------|-------|---|
| 84293 9 | 17,0 x 8,5 | 4 | 0,2 | ● |
| 84298 4 | 17,0 x 8,5 | 4 | 0,2 | ○ |



Teller/Tablett „LA VIDA“
plate/tray
plato/bandeja
assiette/plateau



| | □ cm | ↑ cm | | GN |
|---------|-------------|------|---|-----|
| 84161 1 | Ø 32,0 | 3,5 | ● | |
| 84170 3 | Ø 40,5 | 5,5 | ● | |
| 84165 9 | Ø 32,0 | 3,5 | ● | |
| 84168 0 | Ø 40,5 | 5,5 | ● | |
| 84171 0 | Ø 32,0 | 3,5 | ● | |
| 84172 7 | Ø 40,5 | 5,5 | ● | |
| 84144 4 | 53,0 x 32,5 | 2,5 | ● | 1/1 |
| 84145 1 | 32,5 x 26,5 | 2,5 | ● | 1/2 |
| 84146 8 | 53,0 x 16,2 | 2,5 | ● | 2/4 |
| 84147 5 | 53,0 x 32,5 | 2,5 | ● | 1/1 |
| 84148 2 | 32,5 x 26,5 | 2,5 | ● | 1/2 |
| 84149 9 | 53,0 x 16,2 | 2,5 | ● | 2/4 |

NEW

NEW

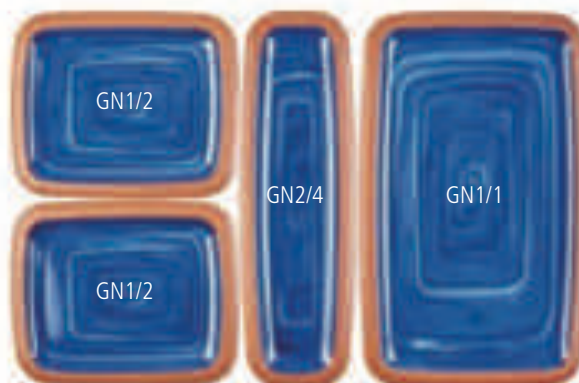



84320



rund/round

**Tablett/Teller „AIKO“
tray
bandeja
plat**



Steinoptik
appearance stoneware
su aspecto recuerda al gres
l'aspect de la mélamine rappelle le grès

| | ☐ cm | ↑ cm | |
|---------|--------|------|---|
| 84320 2 | Ø 16 | 2 | ○ |
| 84321 9 | Ø 16 | 2 | ● |
| 84322 6 | Ø 26,5 | 2,5 | ○ |
| 84323 3 | Ø 26,5 | 2,5 | ● |



84322

Tablett/Teller „AIKO“
tray
bandeja
plat



oval

Steinoptik
appearance stoneware
su aspecto recuerda al gres
l'aspect de la mélamine rapelle le grès

| | ▣ cm | ↑ cm | |
|---------|---------|------|---|
| 84324 0 | 33 x 25 | 2,5 | ○ |
| 84325 7 | 33 x 25 | 2,5 | ● |

Schale „AIKO“
bowl
cuenco
bol



84327

oval

Steinoptik
appearance stoneware
su aspecto recuerda al gres
l'aspect de la mélamine rapelle le grès

| | ▣ cm | ↑ cm | ltr. | |
|---------|-------------|------|------|---|
| 84326 4 | 26,5 x 19,5 | 6 | 0,9 | ○ |
| 84327 1 | 26,5 x 19,5 | 6 | 0,9 | ● |

Schale „AIKO“
bowl
cuenco
bol



84328



84331

Steinoptik
appearance stoneware
su aspecto recuerda al gres
l'aspect de la mélamine rapelle le grès

| | ▣ cm | ↑ cm | ltr. | |
|---------|--------|------|------|---|
| 84328 8 | Ø 8 | 4 | 0,07 | ○ |
| 84329 5 | Ø 8 | 4 | 0,07 | ● |
| 84330 1 | Ø 11,5 | 6 | 0,2 | ○ |
| 84331 8 | Ø 11,5 | 6 | 0,2 | ● |

Schale „AIKO“
bowl
cuenco
bol



0,3 - 1,2 ltr.

84337

Steinoptik
appearance stoneware
su aspecto recuerda al gres
l'aspect de la mélamine rapelle le grès

| | ▣ cm | ↑ cm | ltr. | |
|---------|--------|------|------|---|
| 84332 5 | Ø 12,5 | 6 | 0,3 | ○ |
| 84333 2 | Ø 12,5 | 6 | 0,3 | ● |
| 84334 9 | Ø 16 | 7 | 0,6 | ○ |
| 84335 6 | Ø 16 | 7 | 0,6 | ● |
| 84336 3 | Ø 20,5 | 8 | 1,2 | ○ |
| 84337 0 | Ø 20,5 | 8 | 1,2 | ● |

MARONE



schwarze Serie in Naturoptik mit braunem Rand

Body in black with brown edge

Formas orgánicas con aspecto parecido a materiales naturales, color negro con borde marrón

Formes organiques à l'apparence proche du naturel, couleur noire avec rebords marron.



84100

Blattschale „MARONE“
leaf
fuente en forma de hoja
plat fenille



| | cm | cm | litr. |
|---------|-----------|-----|-------|
| 84100 0 | 25,5 x 14 | 5,5 | 0,4 |
| 84101 7 | 36 x 19 | 8 | 0,9 |



84101

Tablett „MARONE“
tray
bandeja
plat



| | cm | cm |
|---------|-------------|----|
| 84103 1 | 14,5 x 14,5 | 2 |



Tablett „MARONE“
tray
bandeja
plat



| | cm | cm |
|---------|-----------|----|
| 84104 8 | 22,5 x 15 | 3 |
| 84105 5 | 27,5 x 11 | 2 |



Tablett „MARONE“
tray
bandeja
plat



| | cm | cm |
|---------|-------------|----|
| 84106 2 | 26,5 x 16,5 | 4 |

NEW



Schale „MARONE“
bowl
cuenco
bol



| | cm | cm | ltr. |
|---------|-------------|-----|------|
| 84114 7 | 23,5 x 23,5 | 6,5 | 0,70 |

NEW



84116

Schale „MARONE“
bowl
cuenco
bol



| | cm | cm | ltr. |
|---------|------|-----|------|
| 84115 4 | Ø 11 | 3,5 | 0,13 |
| 84116 1 | Ø 14 | 4 | 0,20 |



84113

Schale „MARONE“
bowl
cuenco
bol



| | cm | cm | ltr. |
|---------|------|-----|------|
| 84110 9 | Ø 14 | 6 | 0,30 |
| 84111 6 | Ø 19 | 8 | 0,80 |
| 84112 3 | Ø 21 | 8,5 | 1,00 |
| 84113 0 | Ø 24 | 9,5 | 1,40 |



Schale „MARONE“
bowl
cuenco
bol



| | cm | cm | ltr. |
|---------|------|-----|------|
| 84109 3 | Ø 11 | 5,5 | 0,2 |



Schale „MARONE“
tray
bandeja
plat



| | cm | cm | ltr. |
|---------|-------|-----|------|
| 84107 9 | Ø 8,5 | 2,5 | 0,05 |



Schale „MARONE“
bowl
cuenco
bol



| | cm | cm | ltr. |
|---------|--------|----|------|
| 84108 6 | Ø 11,5 | 3 | 0,04 |

ZEN

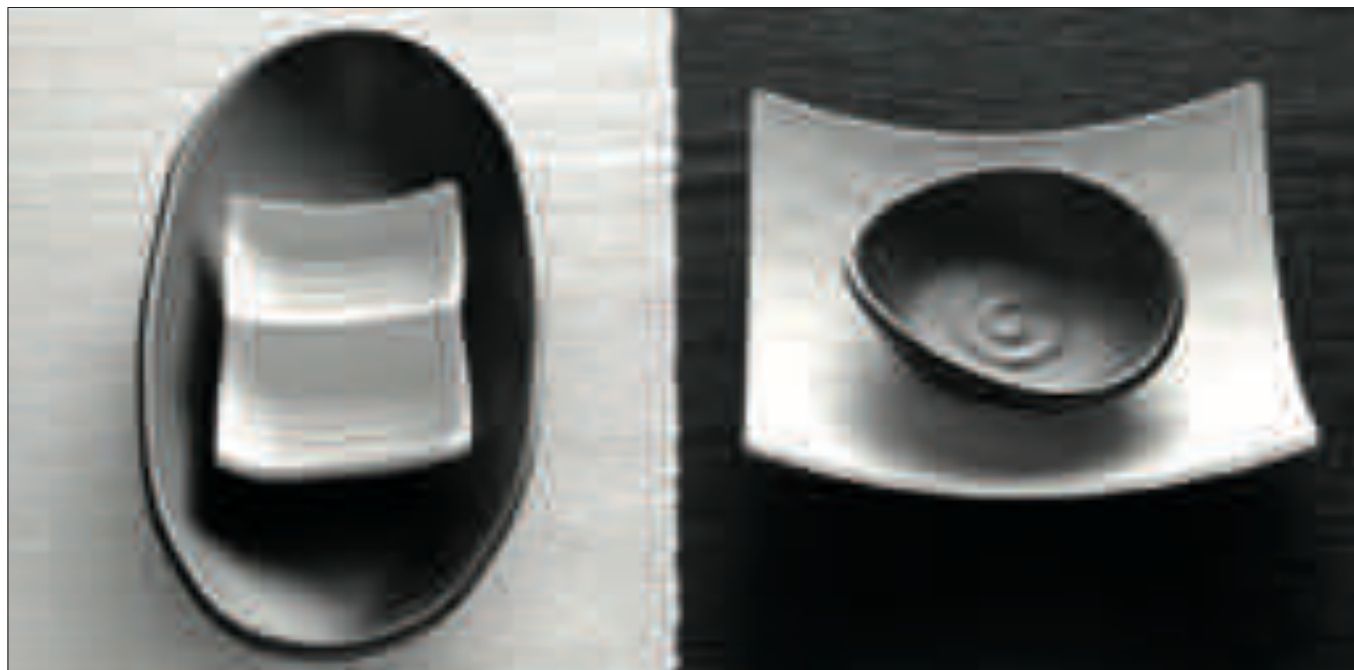

Fernöstliche Tisch- und Buffetartikel präsentiert die Serie **ZEN**.

Japanische und chinesische Köstlichkeiten können traditionell in Szene gesetzt werden. Die Optik entspricht dem japanischen Steingut.

The **ZEN** series presents Far Eastern table and buffet articles.

Japanese and Chinese specialties can be served in a traditional setting.

The appearance is that of Japanese stoneware.

La colección **ZEN** presenta artículos de bufé y mesa para cocina oriental. Las delicias japonesas y chinas se pueden poner en escena siguiendo la tradición. Su aspecto recuerda al gres japonés.

La collection **ZEN** présente des articles de buffet et de table pour la cuisine orientale. Les délices japonaises et chinoises entrent en scène selon la plus pure tradition. L'aspect de la mélamine rappelle le grès japonais.



Schale „ZEN“
bowl
cuenco
bol



| | ▣ cm | ↑ cm | |
|---------|------|------|---|
| 83928 1 | Ø 31 | 8,5 | ○ |
| 83929 8 | Ø 31 | 8,5 | ● |



Schale „ZEN“
bowl
cuenco
bol



| | ▣ cm | ↑ cm | ltr. | |
|---------|---------|------|------|---|
| 83710 2 | 21 x 21 | 11 | 1,4 | ○ |
| 83712 6 | 21 x 21 | 11 | 1,4 | ● |

NEW



**Schale „ZEN“
bowl
cuenco
bol**



| | □ cm | ↑ cm | litr. | |
|---------|--------|------|-------|---|
| 84354 7 | Ø 22,5 | 12,5 | 0,80 | ○ |
| 84355 4 | Ø 22,5 | 12,5 | 0,80 | ● |

NEW



84351

**Schale „ZEN“
bowl
cuenco
bol**



| | □ cm | ↑ cm | litr. | |
|---------|--------|------|-------|---|
| 84348 6 | Ø 10 | 7 | 0,08 | ○ |
| 84349 3 | Ø 10 | 7 | 0,08 | ● |
| 84350 9 | Ø 12,5 | 8,5 | 0,15 | ○ |
| 84351 6 | Ø 12,5 | 8,5 | 0,15 | ● |
| 84352 3 | Ø 16 | 10 | 0,30 | ○ |
| 84353 0 | Ø 16 | 10 | 0,30 | ● |

NEW



84341

**Schale „ZEN“
bowl
cuenco
bol**



| | □ cm | ↑ cm | litr. | |
|---------|-----------|------|-------|---|
| 84340 0 | 7 x 7 | 2 | 0,03 | ○ |
| 84341 7 | 7 x 7 | 2 | 0,03 | ● |
| 84342 4 | 9 x 9 | 2,5 | 0,06 | ○ |
| 84343 1 | 9 x 9 | 2,5 | 0,06 | ● |
| 84344 8 | 13,5 x 13 | 4 | 0,20 | ○ |
| 84345 5 | 13,5 x 13 | 4 | 0,20 | ● |
| 84346 2 | 16 x 15,5 | 4,5 | 0,30 | ○ |
| 84347 9 | 16 x 15,5 | 4,5 | 0,30 | ● |

NEW



**Schale „ZEN“
bowl
cuenco
bol**



| | □ cm | ↑ cm | litr. | |
|---------|------------|------|-------|---|
| 83729 4 | 18 x 10 | 3,5 | 0,10 | ○ |
| 83731 7 | 18 x 10 | 3,5 | 0,10 | ● |
| 83733 1 | 25 x 13,5 | 4 | 0,25 | ○ |
| 83735 5 | 25 x 13,5 | 4 | 0,25 | ● |
| 83737 9 | 30,5 x 7,5 | 5 | 0,60 | ○ |
| 83739 3 | 30,5 x 7,5 | 5 | 0,60 | ● |



**Schale „ZEN“
bowl
cuenco
bol**



| | □ cm | ↑ cm | litr. | |
|---------|-------------|------|-------|---|
| 83714 0 | 17,5 x 17,5 | 7 | 0,5 | ○ |
| 83716 4 | 17,5 x 17,5 | 7 | 0,5 | ● |

NEW



Dipschälchen „ZEN“
bowl
cuencos para salsas
ramequin



| | cm | cm | litr. | |
|---------|-----|-----|-------|---|
| 83721 8 | Ø 8 | 1,5 | 0,03 | ○ |
| 83723 2 | Ø 8 | 1,5 | 0,03 | ● |

NEW



Schale „ZEN“
bowl
cuenco
bol



| | cm | cm | litr. | |
|---------|-------------|----|-------|---|
| 83725 6 | 10,5 x 10,5 | 3 | 0,06 | ○ |
| 83727 0 | 10,5 x 10,5 | 3 | 0,06 | ● |



Schale „ZEN“
bowl
cuenco
bol



| | cm | cm | litr. | |
|---------|---------|-----|-------|---|
| 83726 3 | 13 x 11 | 3,5 | 0,1 | ○ |
| 83728 7 | 13 x 11 | 3,5 | 0,1 | ● |



Schale „ZEN“
bowl
cuenco
bol



| | cm | cm | litr. | |
|---------|---------|----|-------|---|
| 83718 8 | 12 x 12 | 4 | 0,2 | ○ |
| 83720 1 | 12 x 12 | 4 | 0,2 | ● |



Schale „ZEN“
bowl
fuente alargada
plat long



| | cm | cm | | |
|---------|-----------|----|--|---|
| 83938 0 | 32,5 x 14 | 4 | | ○ |
| 83939 7 | 32,5 x 14 | 4 | | ● |



Schale „ZEN“
bowl
cuenco
bol



| | cm | cm | litr. | |
|---------|---------|----|-------|---|
| 83730 0 | 11 x 10 | 3 | 0,04 | ○ |
| 83732 4 | 11 x 10 | 3 | 0,04 | ● |



Schale „ZEN“
bowl
cuenco
bol



| | cm | cm | litr. | |
|---------|-------------|-----|-------|---|
| 83722 5 | 17,5 x 15,5 | 5,5 | 0,2 | ○ |
| 83724 9 | 17,5 x 15,5 | 5,5 | 0,2 | ● |



Schale „ZEN“
bowl
cuenco
bol



| | cm | cm | litr. | |
|---------|-------------|----|-------|---|
| 83934 2 | 14,5 x 12,5 | 5 | 0,2 | ○ |
| 83935 9 | 14,5 x 12,5 | 5 | 0,2 | ● |



Schale „ZEN“
bowl
cuenco
bol



| | cm | cm | litr. | |
|---------|--------|----|-------|---|
| 83932 8 | Ø 11,5 | 4 | 0,15 | ○ |
| 83933 5 | Ø 11,5 | 4 | 0,15 | ● |



Schale „ZEN“
bowl
cuenco
bol



| | cm | cm | litr. | |
|---------|-------|-----|-------|---|
| 83946 5 | 9 x 7 | 2,5 | 0,05 | ○ |
| 83947 2 | 9 x 7 | 2,5 | 0,05 | ● |



Tablett/Teller „ZEN“
tray
bandeja
plat



| | cm | cm | |
|---------|------|----|---|
| 83940 3 | Ø 28 | 3 | ○ |
| 83941 0 | Ø 28 | 3 | ● |



Tablett „ZEN“
tray
bandeja
plat



| | cm | cm | |
|---------|-----------|----|---|
| 83936 6 | 24 x 12,5 | 2 | ○ |
| 83937 3 | 24 x 12,5 | 2 | ● |



Tablett „ZEN“
tray
bandeja
plat



| | cm | cm | |
|---------|-----------|-----|---|
| 83734 8 | 23 x 23,5 | 5,5 | ○ |
| 83736 2 | 23 x 23,5 | 5,5 | ● |



Tablett, Sushiboard „ZEN“
tray, sushiboard
bandeja para sushi
plat sushi



| | cm | cm | |
|---------|------------|----|---|
| 83742 3 | 22,5 x 9,5 | 3 | ○ |
| 83744 7 | 22,5 x 9,5 | 3 | ● |



Tablett, Sushiboard „ZEN“
tray, sushiboard
bandeja para sushi
plat sushi



| | cm | cm | |
|---------|---------|----|---|
| 83738 6 | 22 x 12 | 3 | ○ |
| 83740 9 | 22 x 12 | 3 | ● |



83942



83943

Tablett, quadratisch „ZEN“
tray, square
bandeja cuadrada
plateau carré



| | cm | cm | |
|---------|---------|-----|---|
| 83942 7 | 20 x 20 | 4,5 | ○ |
| 83944 1 | 25 x 25 | 5,5 | ○ |
| 83943 4 | 20 x 20 | 4,5 | ● |
| 83945 8 | 25 x 25 | 5,5 | ● |



Schale „ZEN“
bowl
cuenco
bol



| | cm | cm | |
|---------|--------|-----|---|
| 83948 9 | 14 x 9 | 2,5 | ○ |
| 83949 6 | 14 x 9 | 2,5 | ● |

FUSION



Tisch- und Buffetservierartikel präsentiert die Serie FUSION. Die Oberflächen der Artikel sind innen hoch glänzend und außen mattiert. Das besondere Design beansprucht höchste Aufmerksamkeit und bringt Speisen optimal zur Geltung. Somit werden die Speisen noch mehr in den Blickpunkt gerückt.

The FUSION presents table and buffet articles. The design and surface is unique. Mirror shiny inside, outside matt.

La línea FUSION presenta artículos para la mesa y el buffet. El diseño y el acabado son únicos, interior pulido brillante y exterior acabado en mate.

La ligne FUSION présente des articles pour la table et le buffet. Le design et la finition sont tout à fait uniques. Intérieur poli brillant et extérieur mat.



84022
Ø 11 cm

Schale „FUSION“ bowl bol plat



| | ☐ cm | ↑ cm | ltr. |
|---------|------|------|------|
| 84022 5 | Ø 11 | 7,0 | 0,3 |
| 84023 2 | Ø 17 | 8,5 | 1,0 |
| 84024 9 | Ø 20 | 8,0 | 1,2 |



84023

Ø 17 cm



84023



84024

Ø 20 cm



84024



84025

Tablett „FUSION“ tray bandeja plateau



| | ☐ cm | ↑ cm |
|---------|------------|------|
| 84025 6 | 23,5 x 7,5 | 2,0 |
| 84026 3 | 24,5 x 6,5 | 1,5 |



84025



84026



84026

HALFTONE



NEW



Löffel „HALFTONE“
spoon
cuchara
cuillère



| | □ cm | ↑ cm |
|---------|-------|------|
| 84158 1 | Ø 5,5 | 7 |

NEW



84227

Teller „HALFTONE“
plate
plato
assiette



| | □ cm | ↑ cm |
|---------|--------|------|
| 84226 7 | Ø 13,5 | 2,5 |
| 84227 4 | Ø 16 | 3 |

NEW



84217

Schale „HALFTONE“
bowl
cuenco
bol



| | □ cm | ↑ cm | ltr. |
|---------|-------|------|------|
| 84217 5 | Ø 8 | 4 | 0,1 |
| 84218 2 | Ø 8,5 | 3,5 | 0,05 |



84218



Fingerfood Löffel „HALFTONE“
party spoon
cuchara party
cuillère party



| | cm | cm |
|---------|------------|-----|
| 84128 4 | 14,5 x 4,5 | 4,5 |



Schale „HALFTONE“
bowl
cuenco
bol



| | cm | cm | ltr. |
|---------|-----------|-----|------|
| 84129 1 | 7,5 x 7,5 | 3,5 | 0,05 |



Schale „HALFTONE“
bowl
cuenco
bol



| | cm | cm | ltr. |
|---------|----------|-----|------|
| 84130 7 | 11,5 x 7 | 4 | 0,05 |
| 84131 4 | 14 x 8 | 4,5 | 0,1 |
| 84132 1 | 15 x 9,5 | 5 | 0,15 |



Schale „HALFTONE“
bowl
cuenco
bol



| | cm | cm | ltr. |
|---------|-------------|-----|------|
| 84133 8 | 17,5 x 13,5 | 6,5 | 0,35 |
| 84134 5 | 24 x 17,5 | 7,5 | 0,8 |



Schale „HALFTONE“
bol
cuenco
bol



| | cm | cm | ltr. |
|---------|--------|-----|------|
| 84135 2 | Ø 16,5 | 7,5 | 0,65 |
| 84136 9 | Ø 19 | 8,5 | 1 |



84120



84120

Blattschale „HALFTONE“
leaf
fuente en forma de hoja
plat feuille



| | cm | cm | cm |
|---------|-------------|-----|----|
| 84120 8 | 37,5 x 15,5 | 4,5 | |
| 84121 5 | 46,5 x 21 | 6,5 | |

Blattschale „HALFTONE“
leaf
fuente en forma de hoja
plat feuille



| | cm | cm | cm |
|---------|---------|----|----|
| 84122 2 | 34 x 13 | 3 | |

Teller „HALFTONE“
plate
plato
assiette



| | cm | cm | cm |
|---------|------|-----|----|
| 84123 9 | Ø 16 | 2,5 | |

Tablett „HALFTONE“
tray
bandeja
assiette



84124, 84125,
84127



84126

| | cm | cm | cm |
|---------|-------------|----|----|
| 84124 6 | 20,5 x 12,5 | 3 | |
| 84125 3 | 24,5 x 15 | 3 | |
| 84127 7 | 34,5 x 21,5 | 3 | |
| 84126 0 | 29 x 18 | 4 | |

Schale „HALFTONE“
bowl
cuenco
bol



| | cm | cm | litr. |
|---------|------|----|-------|
| 84137 6 | Ø 26 | 9 | 1,5 |

SINUS

designed by **CULTURE FORM**

Charakterstark und mit dem hohen Anspruch an Funktionalität und Design präsentiert sich die Buffetserie SINUS. Die großzügigen Flächen für die Speisenpräsentation sind ausdrucksstark eingefasst und gewährleisten ein optimales Handling im Gastronomiealltag.

Buffetrange SINUS presents a modern look and feel of this endearing Gastro Norm series disguises the functional and versatile features.

SINUS: carácter, funcionalidad y diseño para el buffet. Las generosas dimensiones de las piezas SINUS se combinan para crear un montaje de buffet práctico y con personalidad apto al uso profesional a diario.

SINUS: Caractère, fonctionnalité et design. Les généreuses dimensions des pièces de la collection et leur combinaison permettent le montage d'un buffet à la fois pratique et de caractère, apte à un intensif usage quotidien.



GN Tablett „SINUS“ tray bandeja plat



GN2/4
84261



GN1/1
84230

84231



84261

| | □ cm | GN | ↑ cm | |
|---------|-----------|-----|------|---|
| 84230 4 | 53 x 32,5 | 1/1 | 2 | ○ |
| 84231 1 | 53 x 16,2 | 2/4 | 2 | ○ |
| 84260 1 | 53 x 32,5 | 1/1 | 2 | ● |
| 84261 8 | 53 x 16,2 | 2/4 | 2 | ● |



4 Größen



0,1 ltr. bis 3,5 ltr.

Schale „SINUS“ bowl cuenco bol



| | □ cm | ↑ cm | litr. |
|---------|-------------|------|-------|
| 84229 8 | 10,5 x 10,5 | 4,0 | 0,1 |
| 84232 8 | 21,0 x 21,0 | 9,0 | 1,5 |
| 84233 5 | 25,0 x 25,0 | 11,0 | 2,4 |
| 84234 2 | 28,5 x 28,5 | 12,5 | 3,5 |

TAO



Tisch- und Buffetservierartikel präsentiert die Serie TAO.
Die Oberflächen der Artikel sind innen hoch glänzend und außen mattiert. Das besondere Design beansprucht höchste Aufmerksamkeit und bringt Speisen optimal zur Geltung. Somit werden die Speisen noch mehr in den Blickpunkt gerückt.

The TAO presents table and buffet articles. The design and surface is unique.
Mirror shiny inside, outside matt.

La línea TAO presenta artículos para la mesa y el buffet.
El diseño y el acabado son únicos, interior pulido brillante y exterior acabado en mate.

La ligne TAO présente des articles pour la table et le buffet.
Le design et la finition sont tout à fait uniques. Intérieur poli brillant et extérieur mat.

Die Schalen sind mit rutschfesten Füßchen
ausgestattet, diese verhindern das Verrutschen.

Bowls have non-slip feet to avoid slipping.

Los boles grandes tienen pies antideslizantes.

Pieds anti-dérapants pour les bols de grande capacité





83640

Schale, rechteckig „TAO“
bowl, rectangular
cuenco
plat creux rectangulaire



| | cm | cm | litr. | |
|---------|-------------|----|-------|---|
| 83639 6 | 32,5 x 17,5 | 10 | 1,8 | ○ |
| 83640 2 | 32,5 x 17,5 | 10 | 1,8 | ● |



83642

Schale, quadratisch „TAO“
bowl, square
bol cuadrado
plat creux carré



| | cm | cm | litr. | |
|---------|-------------|----|-------|---|
| 83642 6 | 30,5 x 30,5 | 10 | 3,3 | ○ |
| 83643 3 | 30,5 x 30,5 | 10 | 3,3 | ● |



83643



83646

Schale, quadratisch „TAO“
bowl, square
bol cuadrado
plat creux carré irrégulier



| | cm | cm | litr. | |
|---------|-------------|------|-------|---|
| 83645 7 | 33,5 x 33,5 | 13,5 | 3,8 | ○ |
| 83646 4 | 33,5 x 33,5 | 13,5 | 3,8 | ● |



Schale „TAO“
bowl
cuenco
plat ovale creux



| | cm | cm | |
|---------|-------------|-----|---|
| 83630 3 | 18,0 x 10,0 | 3,5 | ○ |
| 83633 4 | 25,0 x 13,5 | 4,5 | ○ |
| 83636 5 | 30,5 x 17,5 | 5,0 | ○ |
| 83631 0 | 18,0 x 10,0 | 3,5 | ● |
| 83634 1 | 25,0 x 13,5 | 4,5 | ● |
| 83637 2 | 30,5 x 17,5 | 5,0 | ● |



TAO

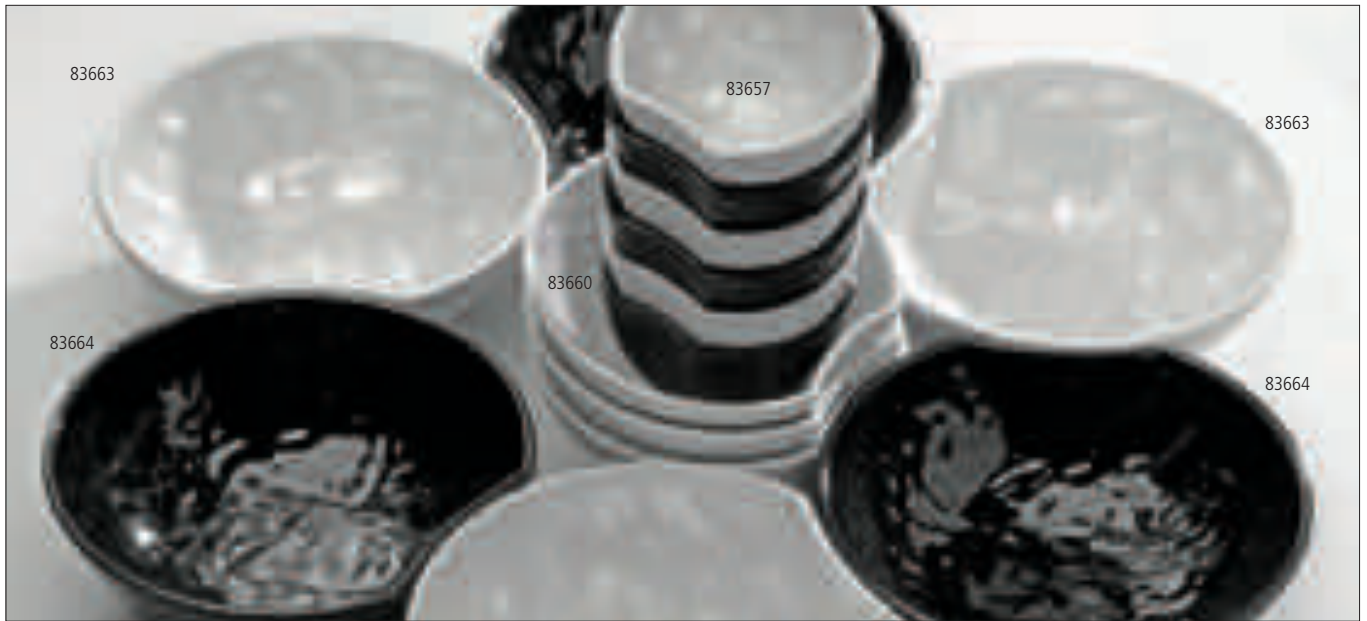

**Schale, rund „TAO“
bowl, round
bol redondo
bol rond avec encoche**



| | ▣ cm | ↑ cm | litr. | |
|---------|-------------|------|-------|---|
| 83657 0 | 9,5 x 9 | 6,0 | 0,15 | ○ |
| 83660 0 | 14,5 x 13,5 | 6,0 | 0,4 | ○ |
| 83663 1 | 18,0 x 16,5 | 6,5 | 0,7 | ○ |
| 83658 7 | 9,5 x 9 | 6,0 | 0,15 | ● |
| 83661 7 | 14,5 x 13,5 | 6,0 | 0,4 | ● |
| 83664 8 | 18,0 x 16,5 | 6,5 | 0,7 | ● |

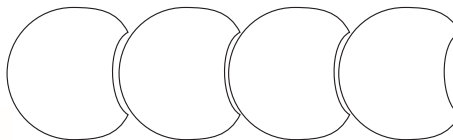

**Schale, rund „TAO“
bowl, round
bol redondo
bol rond coupe optique**



| | ▣ cm | ↑ cm | litr. | |
|---------|-------------|------------|-------|---|
| 83648 8 | 10,5 x 10,0 | 6,5 / 3,0 | 0,07 | ○ |
| 83651 8 | 13,5 x 12,5 | 8,5 / 4,0 | 0,15 | ○ |
| 83654 9 | 17,0 x 16,0 | 10,5 / 4,5 | 0,3 | ○ |
| 83649 5 | 10,5 x 10,0 | 6,5 / 3,0 | 0,07 | ● |
| 83652 5 | 13,5 x 12,5 | 8,5 / 4,0 | 0,15 | ● |
| 83655 6 | 17,0 x 16,0 | 10,5 / 4,5 | 0,3 | ● |



Tablett 83625

GLOBAL BUFFET



Schale „GLOBAL BUFFET“
bowl
cuenco
bol



| | □ cm | ↑ cm | ltr. | |
|---------|-------------|------|------|---|
| 83785 0 | 32,5 x 32,5 | 12,0 | 3,0 | ○ |
| 83786 7 | 35,0 x 35,0 | 12,5 | 3,5 | ○ |
| 83787 4 | 40,0 x 40,0 | 13,5 | 5,0 | ○ |
| 84785 9 | 32,5 x 32,5 | 12,0 | 3,0 | ● |
| 84786 6 | 35,0 x 35,0 | 12,5 | 3,5 | ● |
| 84787 3 | 40,0 x 40,0 | 13,5 | 5,0 | ● |

Schale „GLOBAL BUFFET“
bowl
cuenco
bol



| | □ cm | ↑ cm | ltr. | |
|---------|--------|------|------|---|
| 83799 7 | ∅ 25,5 | 13,0 | 3,0 | ○ |
| 83788 1 | ∅ 32,0 | 16,5 | 4,5 | ○ |
| 83789 8 | ∅ 35,0 | 17,0 | 6,0 | ○ |
| 83790 4 | ∅ 40,0 | 17,5 | 8,0 | ○ |
| 83779 9 | ∅ 25,5 | 13,0 | 3,0 | ● |
| 84788 0 | ∅ 32,0 | 16,5 | 4,5 | ● |
| 84789 7 | ∅ 35,0 | 17,0 | 6,0 | ● |
| 84790 3 | ∅ 40,0 | 17,5 | 8,0 | ● |

Schale „GLOBAL BUFFET“
bowl
cuenco
bol



| | □ cm | ↑ cm | ltr. |
|---------|---------|------|------|
| 83791 1 | 32 x 32 | 12,0 | 2,5 |
| 83792 8 | 36 x 36 | 12,5 | 4,0 |
| 83793 5 | 40 x 40 | 14,0 | 5,5 |

Tablett „GLOBAL BUFFET“
tray
bandeja
plat



| | □ cm | ↑ cm | |
|---------|-------------|------|------------------------|
| 83794 2 | 30,5 x 30,5 | 4 | quadratisch/square |
| 83795 9 | 36,0 x 36,0 | 5 | quadratisch/square |
| 83796 6 | 38,5 x 29,5 | 5 | rechteckig/rectangular |
| 83797 3 | 44,0 x 34,5 | 5 | rechteckig/rectangular |

83796, 83797

BALANCE designed by CULTURE FORM



stapelbar
stackable
apilables
empilable



0,4 - 5,0 ltr.

Das Gleichgewicht von Eleganz und Funktionalität prägt das Design der Serie **BALANCE**. Dabei garantiert der charakteristische „Kragen“ optimales Handling und perfekte Stapelbarkeit. In Kombination mit unseren Buffetständern setzt die neue Serie Akzente auf Ihrem Buffet.

The balance of elegance and function makes the design of the range **BALANCE**. There by the characteristics of the „collar“ guarantees perfect handling and stackability. In combination with our buffet stands this new range makes the different on your buffet.

El equilibrio entre la elegancia y la funcionalidad constituyen el diseño de la gama **BALANCE**. Además las características del borde con un escalón garantizan un perfecto manejo y apilamiento.

L'équilibre entre l'élégance et la fonctionnalité constituent le design de la collection **BALANCE**. Le rebord supérieur garantit un empilage parfait et facile manipulation.



Schale „BALANCE“
bowl
cuenco
saladier



| | □ cm | ↑ cm | ltr. | |
|---------|--------|------|------|---|
| 84040 9 | Ø 14,5 | 9,0 | 0,4 | ○ |
| 84041 6 | Ø 21,0 | 13,0 | 1,5 | ○ |
| 84042 3 | Ø 24,5 | 15,0 | 2,5 | ○ |
| 84043 0 | Ø 30,0 | 19,5 | 5,0 | ○ |
| 85040 8 | Ø 14,5 | 9,0 | 0,4 | ● |
| 85041 5 | Ø 21,0 | 13,0 | 1,5 | ● |
| 85042 2 | Ø 24,5 | 15,0 | 2,5 | ● |
| 85043 9 | Ø 30,0 | 19,5 | 5,0 | ● |



84042

passende
Buffet-Ständer
03622, 03623

mit Antirutsch-Füßchen
non-slip feet
con pies antideslizantes
avec pieds anti-dérapants



designed by **CULTURE FORM**

Tablett „BALANCE“
tray
bandeja
assiette



26,5 x 26,5 - 84978

| | ▣ cm | ↑ cm | GN | |
|---------|-------------|------|-----|---|
| 84970 9 | 53,0 x 32,5 | 3 | 1/1 | ○ |
| 84972 3 | 32,5 x 26,5 | 3 | 1/2 | ○ |
| 84974 7 | 53,0 x 16,2 | 3 | 2/4 | ○ |
| 84976 1 | 26,5 x 16,2 | 3 | 1/4 | ○ |
| 84978 5 | 26,5 x 26,5 | 3 | | ○ |
| 84971 6 | 53,0 x 32,5 | 3 | 1/1 | ● |
| 84973 0 | 32,5 x 26,5 | 3 | 1/2 | ● |
| 84975 4 | 53,0 x 16,2 | 3 | 2/4 | ● |
| 84977 8 | 26,5 x 16,2 | 3 | 1/4 | ● |
| 84979 2 | 26,5 x 26,5 | 3 | | ● |



GN1/1 - 84970



GN2/4 - 84974



GN1/4 - 84977

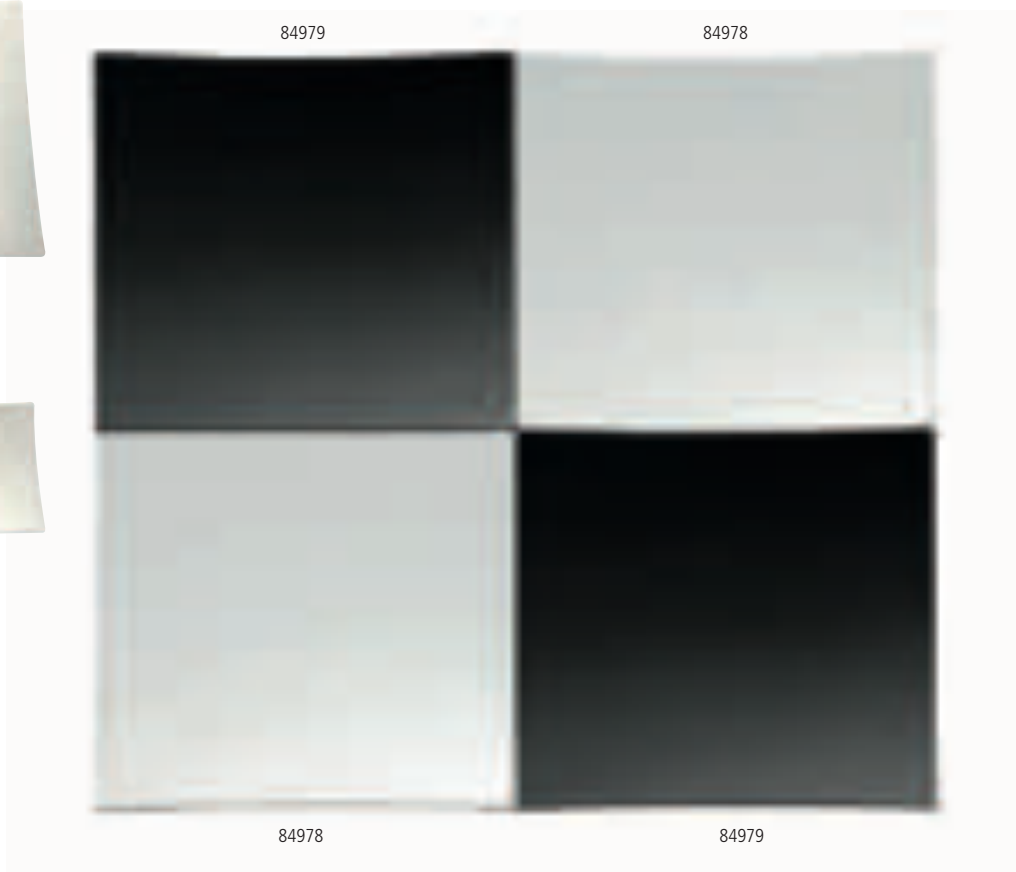

84977

Melamin
melamine

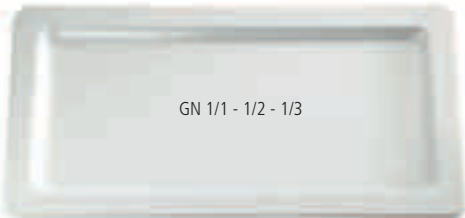

Tablett „APART“
tray
bandeja
plateau



| | □ cm | ↑ cm | GN |
|---------|-------------|------|-----|
| 83828 4 | 53,0 x 32,5 | 2,5 | 1/1 |
| 83830 7 | 32,5 x 26,5 | 2,5 | 1/2 |
| 83832 1 | 32,5 x 17,6 | 2,5 | 1/3 |

| | | | |
|---------|-------------|-----|--|
| 83834 5 | 23,0 x 23,0 | 2,5 | |
| 83836 9 | 33,0 x 33,0 | 2,5 | |
| 83838 3 | 53,0 x 53,0 | 2,5 | |



Tablett, rund „APART“
tray, round
bandeja, redonda
plateau rond



| | □ cm | ↑ cm |
|---------|------|------|
| 83840 6 | Ø 37 | 2,5 |

Einzelteile / spare parts / piezas sueltas / pièces détachées



Frischhalte-Haube / cover / campana / cloche

| | | | |
|---------|------|------|--|
| 06515 4 | Ø 33 | 12,5 | |
| 06516 1 | Ø 33 | 12,5 | schwarzer Griff / black handle botón negro / bouton noir |
| 06517 8 | Ø 33 | 12,5 | mit verchromtem Griff chrom plated handle botón cromado bouton chromé |

06515



**Schale, rund „APART“
bowl, round
cuenco, redonda
saladier rond**



| | □ cm | ↑ cm | ltr. |
|---------|--------|------|-------|
| 83800 0 | Ø 6,5 | 3,0 | 0,045 |
| 83802 4 | Ø 10,0 | 4,5 | 0,130 |
| 83804 8 | Ø 15,0 | 6,5 | 0,500 |
| 83806 2 | Ø 20,0 | 9,0 | 1,200 |



**Schale „APART“
bowl
cuenco
saladier carré**



| | □ cm | ↑ cm | ltr. |
|---------|-----------|------|------|
| 83808 6 | 6,6 x 6,6 | 3,0 | 0,05 |
| 83810 9 | 10 x 10 | 4,5 | 0,17 |
| 83812 3 | 15 x 15 | 6,5 | 0,50 |
| 83814 7 | 20 x 20 | 9,0 | 1,60 |
| 83816 1 | 25 x 25 | 9,0 | 2,60 |



**Schale „APART“
bowl
cuenco
saladier carré profond**



| | □ cm | ↑ cm | ltr. |
|---------|---------|------|------|
| 83818 5 | 25 x 25 | 12,5 | 3,8 |
| 83820 8 | 30 x 30 | 12,5 | 4,5 |



**Schale „APART“
bowl
cuenco
plat rectangulaire creux**



| | □ cm | ↑ cm | ltr. |
|---------|---------|------|------|
| 83822 2 | 30 x 15 | 6,5 | 1,2 |
| 83824 6 | 40 x 20 | 6,5 | 2,4 |



GN2/4

**Schale „APART“
bowl
cuenco
plat rectangulaire allongé**



| | □ cm | ↑ cm | ltr. | GN |
|---------|-------------|------|------|-----|
| 83826 0 | 53,0 x 16,2 | 6,5 | 3 | 2/4 |



SYSTEM-THEKE designed by CULTURE FORM

professionelle Lebensmittelpräsentation



Baukasten-System



Das System umfasst 34 Schalen und Platten in den Farben schwarz und weiß. Passend zu den Schalen sind 5 transparente Deckel im Angebot. Die Vorteile: Ein flexibles Baukastensystem für Thekentieffen 70 bis 90 cm. Keine Lücken in der Theke, variable Füllmengen und einheitliche Optik. Ein größerer Radius ermöglicht ein einfaches Handling, die Elemente lassen sich leicht aus der Theke nehmen, mit Stapelnocke.

System consists of 34 bowls and trays each in black and white colour. Properly to the bowls 5 transparent covers are available. Advantages: flexible modular system for counter depth 70 to 90 cm, no gap inside the counter, variable filling quantities, uniform design. The stable edge allows an easy and fast stackle and therefore no scratching or jamming of the bowls.

El sistema para mostradores de alimentación consiste en 34 bandejas y cuencos disponibles en blanco o negro, con 5 modelos distintos de tapas transparentes. Todo son ventajas. El sistema permite combinaciones flexibles para mostradores de 70 a 90 cm de profundidad, sin huecos en el mostrador, con capacidades variables y con un diseño elegante y uniforme. Las esquinas dejan el espacio suficiente para que se pueda quitar y poner los recipientes con fácil manejo, sin roces ni ralladuras.

Ce système élégant et pratique de présentation pour vitrines d'alimentation comprend 34 références de plats et bols en noir et en blanc. Et 5 couvercles transparents. Avantages: système modulaire flexible pour comptoirs prof. 70-90 cm, sans espaces vides et en même temps commodité de préhension grâce à la forme des angles des récipients, pour les retirer ou remettre facilement.

Deckel transparent, mit Löffelaussparung
cover, transparent, with notched for spoons
tapa transparente, con espacio para la cuchara
couvercle transparent avec encoche pour la cuillère



| | | matches |
|--------------|---|-------------|
| 84054 | 6 | 22 x 14,5 |
| 84050-84053, | | 84150-84153 |
| 84058 | 4 | 22 x 22,0 |
| 84055-84057, | | 84155-84157 |
| 84061 | 4 | 29 x 22,0 |
| 84059-84060, | | 84159-84160 |
| 84065 | 2 | 29 x 29,0 |
| 84062-84064, | | 84162-84164 |
| 84068 | 3 | 44 x 22,0 |
| 84066-84067, | | 84166-84167 |



Tablett 84050, 84062, 84066, 84069



quadratisch
und
rechteckig



„SYSTEM-THEKE“
System-counter
Sistema para mostrador
Système-Comptoir



| | □ cm | ↑ cm | litr. | |
|---------|-----------|------|-------|---|
| 84050 8 | 22 x 14,5 | 2 | - | ○ |
| 84051 5 | 22 x 14,5 | 4 | 0,7 | ○ |
| 84052 2 | 22 x 14,5 | 6 | 1,0 | ○ |
| 84053 9 | 22 x 14,5 | 9 | 1,7 | ○ |
| 84055 3 | 22 x 22,0 | 4 | 1,0 | ○ |
| 84056 0 | 22 x 22,0 | 6 | 1,8 | ○ |
| 84057 7 | 22 x 22,0 | 9 | 3,0 | ○ |
| 84073 7 | 28 x 21,0 | 4 | 1,5 | ○ |
| 84059 1 | 29 x 22,0 | 4 | 1,3 | ○ |
| 84060 7 | 29 x 22,0 | 6 | 2,1 | ○ |
| 84062 1 | 29 x 29,0 | 2 | - | ○ |
| 84063 8 | 29 x 29,0 | 4 | 1,5 | ○ |
| 84064 5 | 29 x 29,0 | 6 | 3,0 | ○ |
| 84076 8 | 42 x 28,0 | 4 | 3,0 | ○ |
| 84066 9 | 44 x 22,0 | 2 | - | ○ |
| 84067 6 | 44 x 22,0 | 4 | 2,0 | ○ |
| 84069 0 | 44 x 29,0 | 2 | - | ○ |



Tablett 84150, 84162, 84166, 84169



rechteckig
und
quadratisch



| | □ cm | ↑ cm | litr. | |
|---------|-----------|------|-------|---|
| 84150 5 | 22 x 14,5 | 2 | - | ● |
| 84151 2 | 22 x 14,5 | 4 | 0,7 | ● |
| 84152 9 | 22 x 14,5 | 6 | 1,0 | ● |
| 84153 6 | 22 x 14,5 | 9 | 1,7 | ● |
| 84155 0 | 22 x 22,0 | 4 | 1,0 | ● |
| 84156 7 | 22 x 22,0 | 6 | 1,8 | ● |
| 84157 4 | 22 x 22,0 | 9 | 3,0 | ● |
| 84173 4 | 28 x 21,0 | 4 | 1,5 | ● |
| 84159 8 | 29 x 22,0 | 4 | 1,3 | ● |
| 84160 4 | 29 x 22,0 | 6 | 2,1 | ● |
| 84162 8 | 29 x 29,0 | 2 | - | ● |
| 84163 5 | 29 x 29,0 | 4 | 1,5 | ● |
| 84164 2 | 29 x 29,0 | 6 | 3,0 | ● |
| 84176 5 | 42 x 28,0 | 4 | 3,0 | ● |
| 84166 6 | 44 x 22,0 | 2 | - | ● |
| 84167 3 | 44 x 22,0 | 4 | 2,0 | ● |
| 84169 7 | 44 x 29,0 | 2 | - | ● |

GASTRONORMBEHÄLTER

GASTRONORM-CONTAINER / FUENTE GASTRONORM / BACS GASTRONORME

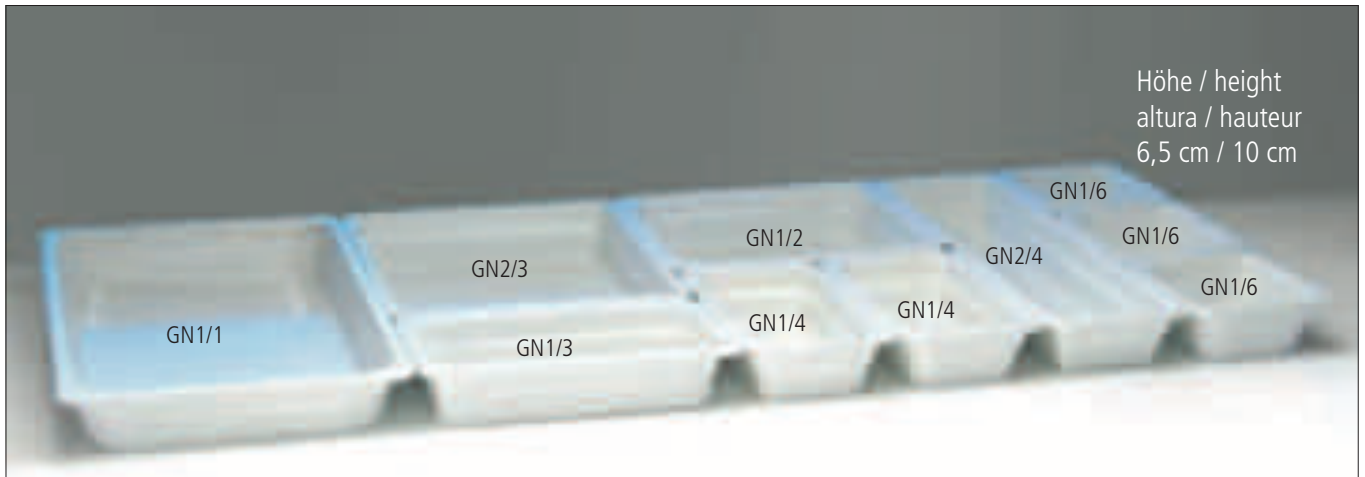

Höhe / height
altura / hauteur
6,5 cm / 10 cm



- Melamin, elfenbein - weiß
- mit Stapelnocke
- superleichtes Stapeln und Entstapeln

- melamin, ivory - white
- with notching edge
- clean ladling and pouring
- not recommend in cookware

- melamina, blanco
- con borde para apilamiento
- muy fáciles de apilar y desapilar
- no recomendado para su uso en marmitas u ollas

- mélamine, blanc ivoirie, encoche pour une louche, faciles à empiler et sésempiler
- usage non recommandé pour marmites ou casseroles



GN-Behälter „HIGHLINE“
GN-container
cubetas GN
bacs Gastronorme



extrem bruchsticher, glänzende und harte Oberfläche, tiefkühlfest, keinen Temperaturschocks unterziehen, nicht auf heißen Flächen liegen lassen, elfenbein - weiß

durable, top quality, hard and glossy surface, avoid thermal shocks, do not leave on hot surfaces, ivory - white

duradera, alta calidad, superficie brillante y resistente. Hay que evitar los cambios térmicos bruscos. No apoyar en superficies calientes, blanco

durable, haute qualité, surface brillante et résistante. Eviter les chocs thermiques et ne pas poser sur une surface chaude, blanc ivoirie



83762



83763

| | □ cm | ↓ mm | GN | litr. |
|---------|-------------|------|-----|-------|
| 83772 0 | 53,0 x 32,5 | 65 | 1/1 | 7,10 |
| 83770 6 | 35,0 x 32,5 | 65 | 2/3 | 4,60 |
| 83768 3 | 32,5 x 26,5 | 65 | 1/2 | 3,40 |
| 83766 9 | 53,0 x 16,2 | 65 | 2/4 | 3,00 |
| 83764 5 | 32,5 x 17,6 | 65 | 1/3 | 2,00 |
| 83762 1 | 26,5 x 16,2 | 65 | 1/4 | 1,35 |
| 83760 7 | 17,6 x 16,2 | 65 | 1/6 | 0,80 |
| 83773 7 | 53,0 x 32,5 | 100 | 1/1 | 11,0 |
| 83769 0 | 32,5 x 26,5 | 100 | 1/2 | 5,50 |
| 83765 2 | 32,5 x 17,6 | 100 | 1/3 | 3,15 |
| 83763 8 | 26,5 x 16,2 | 100 | 1/4 | 2,20 |
| 83761 4 | 17,6 x 16,2 | 100 | 1/6 | 1,25 |

**HOT
PRICE**

GN-Behälter „ECOLINE“
GN container
GN cubeta superior
GN bac supérieur



mit Stapelnocke
 with notching edge
 con borde marcado para el apilado
 avec rebord pour l'empilage



GN1/1
 83759 65 mm
 84300 100 mm



GN1/2
 83756 65 mm
 84307 100 mm



GN2/4
 83755 65 mm
 84302 100 mm



GN1/3
 83752 65 mm
 84309 100 mm



GN1/4
 83751 65 mm
 84304 100 mm



GN1/6
 83748 65 mm
 84311 100 mm



GN1/6
 83749 65 mm
 84305 100 mm



GN2/4
 83754 65 mm
 84308 100mm

| | □ cm | ↓ mm | GN | litr. | |
|---------|-------------|------|-----|-------|---|
| 83759 1 | 53,0 x 32,5 | 65 | 1/1 | 7,10 | ○ |
| 83757 7 | 32,5 x 26,5 | 65 | 1/2 | 3,40 | ○ |
| 83755 3 | 53,0 x 16,2 | 65 | 2/4 | 3,00 | ○ |
| 83753 9 | 32,5 x 17,6 | 65 | 1/3 | 2,00 | ○ |
| 83751 5 | 26,5 x 16,2 | 65 | 1/4 | 1,35 | ○ |
| 83749 2 | 17,6 x 16,2 | 65 | 1/6 | 0,80 | ○ |
| <hr/> | | | | | |
| 83758 4 | 53,0 x 32,5 | 65 | 1/1 | 7,10 | ● |
| 83756 0 | 32,5 x 26,5 | 65 | 1/2 | 3,40 | ● |
| 83754 6 | 53,0 x 16,2 | 65 | 2/4 | 3,00 | ● |
| 83752 2 | 32,5 x 17,6 | 65 | 1/3 | 2,00 | ● |
| 83750 8 | 26,5 x 16,2 | 65 | 1/4 | 1,35 | ● |
| 83748 5 | 17,6 x 16,2 | 65 | 1/6 | 0,80 | ● |
| <hr/> | | | | | |
| 84300 4 | 53,0 x 32,5 | 100 | 1/1 | 10,6 | ○ |
| 84301 1 | 32,5 x 26,5 | 100 | 1/2 | 4,7 | ○ |
| 84302 8 | 53,0 x 16,2 | 100 | 2/4 | 4,3 | ○ |
| 84303 5 | 32,5 x 17,6 | 100 | 1/3 | 2,7 | ○ |
| 84304 2 | 26,5 x 16,2 | 100 | 1/4 | 1,9 | ○ |
| 84305 9 | 17,6 x 16,2 | 100 | 1/6 | 1,0 | ○ |
| <hr/> | | | | | |
| 84306 6 | 53,0 x 32,5 | 100 | 1/1 | 10,6 | ● |
| 84307 3 | 32,5 x 26,5 | 100 | 1/2 | 4,7 | ● |
| 84308 0 | 53,0 x 16,2 | 100 | 2/4 | 4,3 | ● |
| 84309 7 | 32,5 x 17,6 | 100 | 1/3 | 2,7 | ● |
| 84310 3 | 26,5 x 16,2 | 100 | 1/4 | 1,9 | ● |
| 84311 0 | 17,6 x 16,2 | 100 | 1/6 | 1,0 | ● |

CASCADE

designed by CULTURE FORM



Gastronorm - size

Gastronorm - Medidas exteriores

Gastronorme - Diensions extérieures

Das **CASCADE** System
The **CASCADE** system
El sistema **CASCADE**
Le système **CASCADE**

Tablett kann als Deckel eingesetzt werden!
tray is also useable as a cover!
¡La bandeja se puede usar como tapa!
Le plat s'utilise aussi comme couvercle



**Schale „CASCADE“
bowl
cuenco
bol**



GN1/2 - 83960



GN2/4 - 83961



GN1/4 - 83962

| | ☐ cm | ↑ cm | GN | ltr. |
|---------|-------------|------|-----|------|
| 83960 1 | 32,5 x 26,5 | 7,5 | 1/2 | 3,65 |
| 83961 8 | 53,0 x 16,2 | 7,5 | 2/4 | 3,65 |
| 83962 5 | 26,5 x 16,2 | 7,5 | 1/4 | 1,50 |
| 83963 2 | 28,5 x 25,5 | 7,5 | | 2,90 |



28,5 x 25,5
83963



83965



83966



83967



83964

**Tablett „CASCADE“
tray
bandeja
plat**



| | ☐ cm | ↑ cm | matches | GN |
|---------|---------|------|---------|-----|
| 83965 6 | 32 x 27 | 2,4 | 83960 | 1/2 |
| 83966 3 | 52 x 16 | 2,4 | 83961 | 2/4 |
| 83967 0 | 26 x 16 | 2,4 | 83967 | 1/2 |
| 83964 9 | 28 x 25 | 2,4 | 83963 | |

Tablett kann als Deckel eingesetzt werden!
tray is also useable as a cover!

¡La bandeja se puede usar como tapa!

Le plat s'utilise aussi comme couvercle



rutschfest stapeln

FLOAT designed by EsserDesign



- inklusive Deckel stapelbar
- Schalenboden fixiert sich auf dem Deckel
- rutschfest (Antirutschfüßchen)

- with spoon and cover stackable
- non-slip feet

- apilables
- con tapa apilable
- la base se fija a la tapa
- apilado estable (pies anti-deslizantes)

- avec couvercle qui permet un empilage parfait
- le pied du bol supérieur s'encadre dans le couvercle
- anti-dérapant



SAN
KUNSTSTOFF



Deckel, transparent, mit Löffelaussparung
 cover, transparent, with notched for spoons
 tapa transparente, con espacio para la cuchara
 couvercle transparent avec encoche pour la louche



83923



83924

**Tablett GN „FLOAT“
tray GN
bandeja GN
plateau GN**



| | ▣ cm | ↑ cm | GN | |
|---------|-------------|------|-----|---|
| 83923 6 | 53,0 x 32,5 | 3 | 1/1 | ○ |
| 83925 0 | 32,5 x 26,5 | 3 | 1/2 | ○ |
| 83924 3 | 53,0 x 32,5 | 3 | 1/1 | ● |
| 83926 7 | 32,5 x 26,5 | 3 | 1/2 | ● |



0,03 ltr. - 1,90 ltr



**Schale, rund „FLOAT“
bowl, round
cuenco, redondo
saladier rond**



| | ▣ cm | ↑ cm | ltr. | |
|---------|--------|------|------|---|
| 83900 7 | ∅ 5,5 | 3,0 | 0,03 | ○ |
| 83902 1 | ∅ 9,0 | 4,5 | 0,15 | ○ |
| 83904 5 | ∅ 13,0 | 6,5 | 0,45 | ○ |
| 83906 9 | ∅ 15,0 | 7,5 | 0,70 | ○ |
| 83908 3 | ∅ 20,5 | 10,0 | 1,90 | ○ |
| 83901 4 | ∅ 5,5 | 3,0 | 0,03 | ● |
| 83903 8 | ∅ 9,0 | 4,5 | 0,15 | ● |
| 83905 2 | ∅ 13,0 | 6,5 | 0,45 | ● |
| 83907 6 | ∅ 15,0 | 7,5 | 0,70 | ● |
| 83909 0 | ∅ 20,5 | 10,0 | 1,90 | ● |



0,03 ltr. - 4,70 ltr



**Schale „FLOAT“
bowl
cuenco
saladier**



| | ▣ cm | ↑ cm | ltr. | |
|---------|-------------|------|------|---|
| 83910 6 | 5,5 x 5,5 | 3,0 | 0,03 | ○ |
| 83912 0 | 9,0 x 9,0 | 4,5 | 0,16 | ○ |
| 83914 4 | 12,5 x 12,5 | 6,0 | 0,50 | ○ |
| 83916 8 | 19 x 19 | 9,5 | 1,90 | ○ |
| 83918 2 | 25 x 25 | 12,0 | 4,70 | ○ |
| 83911 3 | 5,5 x 5,5 | 3,0 | 0,03 | ● |
| 83913 7 | 9,0 x 9,0 | 4,5 | 0,16 | ● |
| 83915 1 | 12,5 x 12,5 | 6,0 | 0,50 | ● |
| 83917 5 | 19 x 19 | 9,5 | 1,90 | ● |
| 83919 9 | 25 x 25 | 12,0 | 4,70 | ● |



83920



83921
83922

**Deckel „FLOAT“, mit Löffelaussparung
cover, with notched for spoons
tapa, con espacio para la cuchara
couverture, avec encoche pour la louche**



| | ▣ cm | ↑ cm | matches |
|---------|---------|------|--------------|
| 83920 5 | ∅ 20,5 | 1,3 | 83908, 83909 |
| 83921 2 | 19 x 19 | 1,3 | 83916, 83917 |
| 83922 9 | 25 x 25 | 1,3 | 83918, 83919 |



Buffet-Gestell „FLOAT SMALL“
buffet stand
soporte bufé
support buffet



Metall verchromt, für 3 Schalen Nr. 83916, 83917
 metal chrome plated, for 3 bowls no. 83916, 83917
 metal cromado, para 3 cuencos N° 83916, 83917
 métal chromé, pour 3 coupelles 83916, 83917

| | ☐ cm | ↑ cm |
|---------|-----------|------|
| 33241 6 | 55,5 x 19 | 15,5 |



Buffet-Gestell „FLOAT BIG“
buffet stand
soporte bufé
support buffet



Metall verchromt, für 3 Schalen Nr. 83914, 83915, für 1 Schale Nr. 83918, 83919
 metal chrome plated, for 3 bowls no. 83914, 83915, for 1 bowl no. 83918, 83919
 metal cromado, para 3 cuencos N° 83914, 83915, para 1 cuenco N° 83918, 83919
 métal chromé, pour 3 coupelles 83914, 83915 ou 1 bol 83918, 83919

| | ☐ cm | ↑ cm |
|---------|---------|------|
| 33242 3 | 39 x 39 | 17 |



- vielseitig einsetzbar
- rutschfest

- multi usable
- non-slip

- versátil
- antideslizante

- utilisations multiples
- anti-dérapant

CLASSIC WAVE designed by EsserDesign



Wellen - Dekor
wave - decor

vielseitig einsetzbar- ideal für den Einsatz am Buffet, Theken, Vorspeisenwagen

versatile - ideal for use on buffets, salad bars or appetizer trays

versátil, ideal para uso en bufés, mostradores, bandejas de aperitivos.

utilisations multiples, anti-dérapant

Schale, oval „CLASSIC WAVE“
owl, oval
fuelle, ovalada
plat ovale



| | ☐ cm | ↑ cm | ltr. |
|---------|---------|------|------|
| 83875 8 | 27 x 17 | 4,0 | 0,80 |
| 83876 5 | 34 x 21 | 4,5 | 1,30 |
| 83877 2 | 47 x 29 | 5,0 | 3,20 |



PURE



Tablett „PURE“
tray
bandeja
plat



| | ▣ cm | ↑ cm | GN | |
|---------|-------------|------|------------|---|
| 83401 9 | 53,0 x 32,5 | 3 | 1/1 | ○ |
| 83480 4 | 32,5 x 26,5 | 3 | 1/2 | ○ |
| 83481 1 | 32,5 x 17,6 | 3 | 1/3 | ○ |
| 83588 7 | 35,4 x 32,5 | 3 | 2/3 | ○ |
| 83482 8 | 26,5 x 16,2 | 3 | 1/4 | ○ |
| 83433 0 | 53,0 x 16,2 | 3 | 2/4 | ○ |
| 83882 6 | 65,0 x 26,5 | 3 | | ○ |
| 83597 9 | 40 x 30 | 3 | Bäcker-Maß | ○ |
| 83598 6 | 60 x 20 | 3 | Bäcker-Maß | ○ |
| 83599 3 | 60 x 40 | 3 | Bäcker-Maß | ○ |
| 83592 4 | 40 x 30 | 3 | Bäcker-Maß | ● |
| 83593 1 | 60 x 20 | 3 | Bäcker-Maß | ● |
| 83594 8 | 60 x 40 | 3 | Bäcker-Maß | ● |
| 83479 8 | 53,0 x 32,5 | 3 | 1/1 | ● |
| 83490 3 | 32,5 x 26,5 | 3 | 1/2 | ● |
| 83491 0 | 32,5 x 17,6 | 3 | 1/3 | ● |
| 83589 4 | 35,4 x 32,5 | 3 | 2/3 | ● |
| 83492 7 | 26,5 x 16,2 | 3 | 1/4 | ● |
| 83434 7 | 53,0 x 16,2 | 3 | 2/4 | ● |



Tablett, Sushiplatte „PURE“
tray
bandeja
plat sushi



| | ▣ cm | ↑ cm | |
|---------|-------------|------|---|
| 83625 9 | 31,0 x 10,5 | 2 | ○ |
| 83417 0 | 30,0 x 21,0 | 3 | ○ |
| 83403 3 | 35,5 x 18,0 | 3 | ○ |
| 83402 6 | 53,0 x 18,0 | 3 | ○ |
| 83626 6 | 31,0 x 10,5 | 2 | ● |
| 83483 5 | 53,0 x 18,0 | 3 | ● |



Tablett quadratisch „PURE“
tray square
bandeja cuadradas
plateau carrés



| | ▣ cm | ↑ cm | |
|---------|-------------|------|---|
| 83418 7 | 18,0 x 18,0 | 3 | ○ |
| 83407 1 | 21,0 x 21,0 | 3 | ○ |
| 83406 4 | 26,5 x 26,5 | 3 | ○ |
| 83405 7 | 37,0 x 37,0 | 3 | ○ |
| 83404 0 | 51,0 x 51,0 | 3 | ○ |
| 83400 2 | 51,0 x 51,0 | 3 | ● |



Tablett/Teller „PURE“
tray
bandeja
plat



| | ▣ cm | ↑ cm | |
|---------|------|------|---|
| 83884 0 | Ø 31 | 2,5 | ○ |
| 83869 7 | Ø 38 | 2,5 | ○ |
| 83886 4 | Ø 41 | 2,5 | ○ |
| 83484 2 | Ø 51 | 2,5 | ○ |



Schale / Pastateller „PURE“
bowl
cuenco
assiette creuse



| | ▣ cm | ↑ cm | ltr. | |
|---------|--------|------|------|---|
| 83412 5 | Ø 32,0 | 7,5 | 1,5 | ○ |
| 83411 8 | Ø 45,5 | 9,0 | 1,7 | ○ |



oval

Teller oval „PURE“
plate oval
plato oval
asslette ovale



| | ▣ cm | ↑ cm | |
|---------|-------------|------|---|
| 83517 7 | 27,0 x 19,5 | 3 | ○ |
| 83493 4 | 30,5 x 22,5 | 3 | ○ |
| 83494 1 | 38,0 x 28,0 | 3 | ○ |



**Schale „PURE“
bowl
cuenco
bol**



| | ☐ cm | ↑ cm | litr. | |
|---------|--------|------|-------|---|
| 83450 7 | Ø 5,5 | 4,0 | 0,02 | ○ |
| 83419 4 | Ø 9,5 | 4,5 | 0,09 | ○ |
| 83453 8 | Ø 13,0 | 6,5 | 0,30 | ○ |
| 83455 2 | Ø 15,0 | 7,5 | 0,45 | ○ |
| 83415 6 | Ø 20,0 | 10,5 | 1,25 | ○ |
| 83451 4 | Ø 5,5 | 4,0 | 0,02 | ● |
| 83452 1 | Ø 9,5 | 4,5 | 0,09 | ● |
| 83454 5 | Ø 13,0 | 6,5 | 0,30 | ● |
| 83456 9 | Ø 15,0 | 7,5 | 0,45 | ● |
| 83457 6 | Ø 20,0 | 10,5 | 1,25 | ● |



**Schale „PURE BICOLOR“
bowl
cuenco
bol**



| | ☐ cm | ↑ cm | litr. | |
|---------|-------------|------|-------|---|
| 84414 8 | 9,0 x 9,0 | 4,0 | 0,14 | ◐ |
| 84410 0 | 12,5 x 12,5 | 6,5 | 0,40 | ◐ |
| 84409 4 | 19,0 x 19,0 | 9,0 | 1,50 | ◐ |
| 84408 7 | 25,0 x 25,0 | 12,0 | 3,80 | ◐ |
| 84415 5 | 9,0 x 9,0 | 4,0 | 0,14 | ◑ |
| 84416 2 | 12,5 x 12,5 | 6,5 | 0,40 | ◑ |
| 84417 9 | 19,0 x 19,0 | 9,0 | 1,50 | ◑ |
| 84418 6 | 25,0 x 25,0 | 12,0 | 3,80 | ◑ |
| 84420 9 | 9,0 x 9,0 | 4,0 | 0,14 | ◒ |
| 84421 6 | 12,5 x 12,5 | 6,5 | 0,40 | ◒ |
| 84422 3 | 19,0 x 19,0 | 9,0 | 1,50 | ◒ |
| 84423 0 | 25,0 x 25,0 | 12,0 | 3,80 | ◒ |



**Schale „PURE COLOR“
bowl
cuenco
bol**



| | ☐ cm | ↑ cm | litr. | |
|---------|-------------|------|-------|---|
| 83414 9 | 9,0 x 9,0 | 4,0 | 0,14 | ○ |
| 83410 1 | 12,5 x 12,5 | 6,5 | 0,40 | ○ |
| 83409 5 | 19,0 x 19,0 | 9,0 | 1,50 | ○ |
| 83408 8 | 25,0 x 25,0 | 12,0 | 3,80 | ○ |
| 83466 8 | 9,0 x 9,0 | 4,0 | 0,14 | ● |
| 83467 5 | 12,5 x 12,5 | 6,5 | 0,40 | ● |
| 83468 2 | 19,0 x 19,0 | 9,0 | 1,50 | ● |
| 83469 9 | 25,0 x 25,0 | 12,0 | 3,80 | ● |
| 83568 9 | 9,0 x 9,0 | 4,0 | 0,14 | ◐ |
| 83570 2 | 12,5 x 12,5 | 6,5 | 0,40 | ◐ |
| 83572 6 | 19,0 x 19,0 | 9,0 | 1,50 | ◐ |
| 83574 0 | 25,0 x 25,0 | 12,0 | 3,80 | ◐ |
| 83569 6 | 9,0 x 9,0 | 4,0 | 0,14 | ◑ |
| 83571 9 | 12,5 x 12,5 | 6,5 | 0,40 | ◑ |
| 83573 3 | 19,0 x 19,0 | 9,0 | 1,50 | ◑ |
| 83575 7 | 25,0 x 25,0 | 12,0 | 3,80 | ◑ |

NEW



83600

Deckel „PURE“, mit Löffelaussparung
cover, with notched for spoons
tapa, con espacio para la cuchara
couvercle, avec encoche pour la louche



| | cm | cm | matches |
|---------|---------|-----|---|
| 83600 6 | 19 x 19 | 1,5 | 84410, 84417, 84422, 83409 83572, 83468, 83573, 84429 |
| 83601 3 | 25 x 25 | 1,5 | 84408, 84418, 84423, 83469, 83574, 83575, 83408, 84430 |

designed by **sieger design**



GN 1/1 - 1/2 - 1/3

Tablett „FRAMES“
tray
bandeja
plat



| | cm | cm | GN | |
|---------|-------------|----|-----|---|
| 84046 1 | 53,0 x 32,5 | 2 | 1/1 | ○ |
| 84047 8 | 32,5 x 26,5 | 2 | 1/2 | ○ |
| 84048 5 | 32,5 x 17,6 | 2 | 1/3 | ○ |



taupe

lemon-grün

Tablett „PURE COLOR“
tray
bandeja
plat



| | cm | cm | GN | |
|---------|-------------|----|-----|---|
| 83560 3 | 53,0 x 32,5 | 3 | 1/1 | ● |
| 83562 7 | 32,5 x 26,5 | 3 | 1/2 | ● |
| 83564 1 | 53,0 x 18,0 | 3 | | ● |
| 83566 5 | 35,5 x 18,0 | 3 | | ● |
| 83561 0 | 53,0 x 32,5 | 3 | 1/1 | ● |
| 83563 4 | 32,5 x 26,5 | 3 | 1/2 | ● |
| 83565 8 | 53,0 x 18,0 | 3 | | ● |
| 83567 2 | 35,5 x 18,0 | 3 | | ● |



Granitoptik

84440
GN 1/1 - 1/2 - 2/4

GN Tablett „PURE GRANIT“
GN tray
GN bandeja
GN plateau



| | cm | cm | GN |
|---------|-------------|----|-----|
| 84440 7 | 53,0 x 32,5 | 3 | 1/1 |
| 84441 4 | 32,5 x 26,5 | 3 | 1/2 |
| 84442 1 | 53,0 x 16,2 | 3 | 2/4 |

Granitoptik



1,5 ltr.
3,8 ltr.

Schale „PURE GRANIT“
bowl
cuenco
bol



| | cm | cm | ltr. |
|---------|---------|----|------|
| 84429 2 | 19 x 19 | 9 | 1,5 |
| 84430 8 | 25 x 25 | 12 | 3,8 |

**Schale „PURE“
bowl
cuenco
bol**



83497
0,8 ltr.



83498
1,5 ltr.



83499
2,4 ltr.

| | □ cm | ↑ cm | ltr. |
|---------|-------------|------|------|
| 83497 2 | 22,5 x 15,5 | 7,5 | 0,8 |
| 83498 9 | 38,5 x 15,5 | 7,5 | 1,5 |
| 83499 6 | 51,0 x 15,5 | 7,5 | 2,4 |



30120



30122

**Tablett „PURE“
tray
bandeja
plat**



Edelstahl matt poliert, passend für Melamin-Schalen 83414 oder 83466
stainless steel satin polished finish, for melamin bowls 83414 or 83466
acero inoxidable mate, apta para cuencos de melamina 83414 o 83466
inox mat, concient pour bols mélamine 83414 et 83466

| | □ cm | |
|---------|---------|---|
| 30120 7 | 20 x 11 | für 2 Schalen / for 2 bowls apta para 2 cuencos / pour 2 bols |
| 30122 1 | 20 x 20 | für 4 Schalen / for 4 bowls apta para 4 cuencos / pour 4 bols |
| 30121 4 | 29 x 20 | für 6 Schalen / for 6 bowls apta para 6 cuencos / pour 6 bols |



30121
Tablett

83414
Schale



83414
Schale

30120
Tablett



**Menage „PURE“
menage
conjunto aperitivo
set apéritif**



5-teilig: 1 Ständer, Edelstahl matt poliert + 4 Melamin-Schalen, weiß (Nr. 83414)
 5 pcs. set: 1 stainless stand satin polished finish + 4 square white bowls (No. 83414)
 5 unidades: 1 soporte, acero inoxidable mate + 4 cuencos de melamina blancos redondos (N° 83414)
 5 pièces: 1 support inox mat + 4 coupelles rondes mélamine blanche ref 83414)

| | | |
|---------|---------|------|
| | ☐ cm | ↑ cm |
| 09923 4 | 17 x 17 | 16 |



**Menage „PURE“
menage
conjunto aperitivo
set apéritif**



4-teilig: 1 Ständer, Edelstahl matt poliert + 3 Melamin-Schalen, weiß (Nr. 83419)
 4 pcs. set: 1 stainless stand satin polished finish + 3 white bowls (No. 83419)
 4 unidades: 1 soporte, acero inoxidable mate + 3 cuencos de melamina blancos redondos (N° 83419)
 4 pièces: 1 support inox mat + 3 coupelles rondes mélamine blanche ref 83419)

| | | |
|---------|---------|------|
| | ☐ cm | ↑ cm |
| 09924 1 | 14 x 14 | 16 |

**drehbar /
schwenkbar**



**Serviergestell „FLEXIBEL“
serving stand
expositor
présentoir**



3-stufig „beweglich / drehbar“, platzsparend zerlegbar
 3 tier, flexible frame, space saving
 3 alturas, marco flexible, ahorra espacio
 3 hauteurs, cadre souple, gagne de la place

| | | |
|---------|-----------|------|
| | ☐ cm | ↑ cm |
| 33243 0 | 45,5 x 32 | 21,5 |



passende Tablett
 83403, 83566 und 83567



**Serviergestell „S-PURE“
serving stand
soporte
support buffet**



für 3 Tablett **quadratisch** 83407 oder 83418
 for 3 trays **square** 83407 or 83418
 para 3 bandeja **cuadradas** 83407 o 83418
 pour 3 plats **carrés** 83407 ou 83418

| | | |
|---------|---------|------|
| | ☐ cm | ↑ cm |
| 33226 3 | 29 x 17 | 41 |

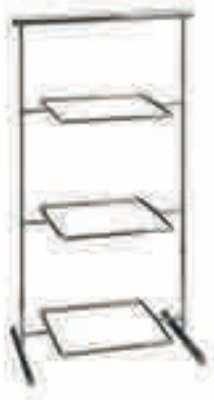

Serviergestell „M-PURE“
serving stand
soporte
support buffet



für 3 Tablett **quadratisch** 83406 oder 83407
 for 3 trays **square** 83406 or 83407
 para 3 bandejas **cuadradas** 83406 o 83407
 pour 3 plats **carrés** 83406 o 83407

| | ☐ cm | ↑ cm | matches |
|---------|---------|------|--------------|
| 33227 0 | 33 x 21 | 44 | 83406, 83407 |



Serviergestell „L-PURE“
serving stand
soporte
support buffet



für 3 Tablett **rechteckig** 83417
 for 3 trays **rectangular** 83417
 para 3 bandejas **rectangulares** 83417
 pour 3 plats **rectangulaires** 83417

| | ☐ cm | ↑ cm | matches |
|---------|---------|------|---------|
| 33228 7 | 37 x 21 | 44 | 83417 |

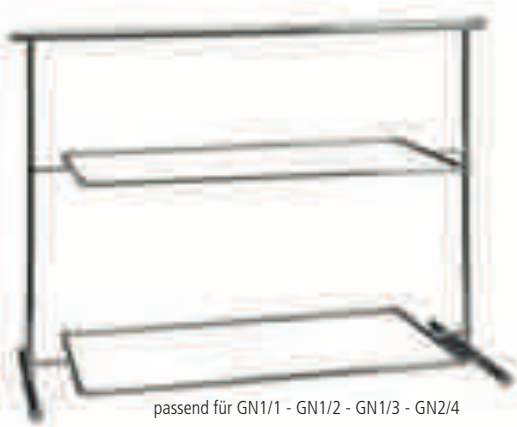

Serviergestell GN „XL-PURE“
serving stand GN
soporte GN
support buffet GN



Passend für Tablett PURE GN1/1, GN1/2, GN1/3, GN2/4
 suitable for tray GN1/1, GN1/2, GN1/3, GN2/4
 aptas para bandejas GN1/1, GN1/2, GN1/3, GN2/4
 convient pour les plats GN1/1, GN1/2, GN1/3, GN2/4

| | ☐ cm | ↑ cm | matches |
|---------|---------|------|-------------------|
| 33222 5 | 63 x 27 | 44,5 | all PURE GN-trays |



Serviergestell „XXL-PURE“
serving stand
soporte
support buffet



für 3 Tablett **quadratisch** 83405 (37 x 37 cm)
 for 3 trays **square** 83405 (37 x 37 cm)
 para 3 bandejas **cuadradas** 83405 (37 x 37 cm)
 pour 3 plats **carrés** 83405 (37 x 37 cm)

| | ☐ cm | ↑ cm | matches |
|---------|---------|------|---------|
| 33234 8 | 45 x 37 | 72 | 83405 |

BASKET

designed by CULTURE FORM

Melamin
melamine



Gastronorm - Außenmaße
Gastronorm - size
Gastronorm - medidas exteriores
Gastronorme - Diensions extérieures



stapelbar
stackable



GN1/2 - 84000



GN1/4 - 84004



GN2/4 - 84003

Schale „BASKET“
bowl
cuenco
bol



| | □ cm | ↑ cm | GN | litr. | |
|---------|-------------|------|-----|-------|---|
| 84000 3 | 32,5 x 26,5 | 8,5 | 1/2 | 3,50 | ○ |
| 84002 7 | 53,5 x 16,2 | 8,5 | 2/4 | 3,20 | ○ |
| 84004 1 | 26,5 x 16,2 | 8,5 | 1/4 | 1,40 | ○ |
| 84006 5 | 25,0 x 25,0 | 10 | | 2,80 | ○ |
| 84001 0 | 32,5 x 26,5 | 8,5 | 1/2 | 3,50 | ● |
| 84003 4 | 53,5 x 16,2 | 8,5 | 2/4 | 3,20 | ● |
| 84005 8 | 26,5 x 16,2 | 8,5 | 1/4 | 1,40 | ● |
| 84007 2 | 25,0 x 25,0 | 10 | | 2,80 | ● |

NATURAL COLLECTION



Blattschale „NATURAL COLLECTION“ leaf fuente en forma de hoja plat feuille



84083, 84086



84084, 84087

| | cm | cm | |
|---------|-----------|-----|---|
| 84083 6 | 40 x 18,5 | 3,5 | ○ |
| 84086 7 | 52 x 25,0 | 4,0 | ○ |
| 84084 3 | 40 x 18,5 | 3,5 | ● |
| 84087 4 | 52 x 25,0 | 4,0 | ● |
| 84085 0 | 40 x 18,5 | 3,5 | ● |
| 84088 1 | 52 x 25,0 | 4,0 | ● |



84085, 84088

Palmbattschale „NATURAL COLLECTION“ bowl fuente en forma de hoja de palmera plat feuille de palme



84080



84081



84082

| | cm | cm | litr. | |
|---------|-----------|----|-------|---|
| 84080 5 | 40 x 18,5 | 10 | 1,8 | ○ |
| 84081 2 | 40 x 18,5 | 10 | 1,8 | ● |
| 84082 9 | 40 x 18,5 | 10 | 1,8 | ● |

stapelbar, mit Löffelablage
stackable, for spoons
apilable, práctico para cubiertos de servicio
empilable, pratique pour déposer les couverts





83864



83863



83862

Blattschale „NATURAL COLLECTION“
leaf
fuente en forma de hoja
plat feuille



| | cm | cm | |
|---------|----------|-----|---|
| 83864 2 | 34,5 x 8 | 2,5 | ○ |
| 83863 5 | 34,5 x 8 | 2,5 | ● |
| 83862 8 | 34,5 x 8 | 2,5 | ● |



Blattschale „NATURAL COLLECTION“
leaf
fuente en forma de hoja
plat feuille



| | cm | cm | |
|---------|---------|-----|---|
| 83435 4 | 36 x 16 | 3,0 | ○ |
| 83438 5 | 45 x 24 | 3,0 | ○ |
| 83441 5 | 53 x 29 | 3,5 | ○ |
| 83436 1 | 36 x 16 | 3,0 | ● |
| 83439 2 | 45 x 24 | 3,0 | ● |
| 83442 2 | 53 x 29 | 3,5 | ● |
| 83437 8 | 36 x 16 | 3,0 | ● |
| 83440 8 | 45 x 24 | 3,0 | ● |
| 83443 9 | 53 x 29 | 3,5 | ● |



Palmbattschale „NATURAL COLLECTION“
tray
fuente en forma de hoja de palmera
plat feuille de palme



| | cm | cm | |
|---------|---------|-----|---|
| 83871 0 | 27 x 27 | 4,5 | ○ |
| 83444 6 | 35 x 34 | 4,5 | ○ |
| 83873 4 | 42 x 42 | 4,5 | ○ |
| 83872 7 | 27 x 27 | 4,5 | ● |
| 83445 3 | 35 x 34 | 4,5 | ● |
| 83874 1 | 42 x 42 | 4,5 | ● |
| 83865 9 | 27 x 27 | 4,5 | ● |
| 83446 0 | 35 x 34 | 4,5 | ● |
| 83866 6 | 42 x 42 | 4,5 | ● |



Palmbattschale „NATURAL COLLECTION“
bowl
fuente en forma de hoja de palmera
plat feuille de palme



| | cm | cm | ltr. | |
|---------|------|------|------|---|
| 83447 7 | ∅ 30 | 10,0 | 1,5 | ○ |
| 83896 3 | ∅ 35 | 12,5 | 4,5 | ○ |
| 83448 4 | ∅ 30 | 10,0 | 1,5 | ● |
| 83895 6 | ∅ 35 | 12,5 | 4,5 | ● |
| 83449 1 | ∅ 30 | 10,0 | 1,5 | ● |
| 83894 9 | ∅ 35 | 12,5 | 4,5 | ● |

CASUAL



2 Größen



Schälchen „CASUAL MINI“
bowl
bol
bol mini



| | cm | cm | litr. | |
|---------|-------|-----|-------|---|
| 83880 2 | Ø 6 | 2,5 | 0,02 | ○ |
| 83881 9 | Ø 7,5 | 3,5 | 0,05 | ○ |

5 Größen



Schale „CASUAL MAXI“
bowl
cuenco
bol



| | cm | cm | litr. | |
|---------|------|------|-------|---|
| 83696 9 | Ø 10 | 4,5 | 0,15 | ○ |
| 83698 3 | Ø 12 | 5,5 | 0,25 | ○ |
| 83700 3 | Ø 14 | 6,5 | 0,50 | ○ |
| 83704 1 | Ø 20 | 9,2 | 1,80 | ○ |
| 83702 7 | Ø 23 | 10,5 | 2,50 | ○ |
| 83697 6 | Ø 10 | 4,5 | 0,15 | ● |
| 83699 0 | Ø 12 | 5,5 | 0,25 | ● |
| 83701 0 | Ø 14 | 6,5 | 0,50 | ● |
| 83705 8 | Ø 20 | 9,2 | 1,80 | ● |
| 83703 4 | Ø 23 | 10,5 | 2,50 | ● |

passender Ø 20 cm Deckel 83920
für Schalen 83704 und 83705

6 Größen



Dip-Schälchen „CASUAL“
bowl
cuencos para salsas
ramequin



| | cm | cm | litr. | |
|---------|-------|-----|-------|---|
| 83780 5 | Ø 6,0 | 3,7 | 0,04 | ○ |
| 83781 2 | Ø 7,0 | 3,7 | 0,05 | ○ |
| 83782 9 | Ø 7,8 | 4,0 | 0,08 | ○ |
| 83783 6 | Ø 8,5 | 4,5 | 0,11 | ○ |
| 83784 3 | Ø 9,8 | 4,5 | 0,14 | ○ |
| 83798 0 | Ø 6,0 | 3,7 | 0,04 | ● |
| 83777 5 | Ø 6,0 | 3,5 | 0,03 | ● |

Serviergestell „CASUAL“
servicing stand
expositor
présentoir



ohne Schalen / Körbe
 without bowls / baskets
 sin bols / cestas
 sans bols / corbeilles

| | □ cm | ↑ cm | |
|---------|------|------|----------|
| 33244 7 | Ø 35 | 46 | 4 x Ø 14 |
| 33245 4 | Ø 48 | 49 | 4 x Ø 20 |



Schale - Ø 14 cm
83700

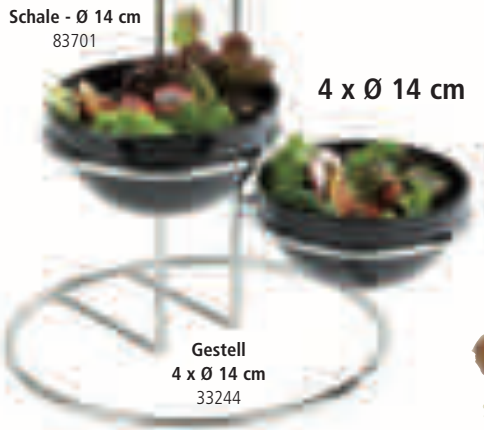

Schale - Ø 14 cm
83701

4 x Ø 14 cm

Gestell
4 x Ø 14 cm
33244



Körbe - Ø 20 cm
50605, 50606 oder 50607

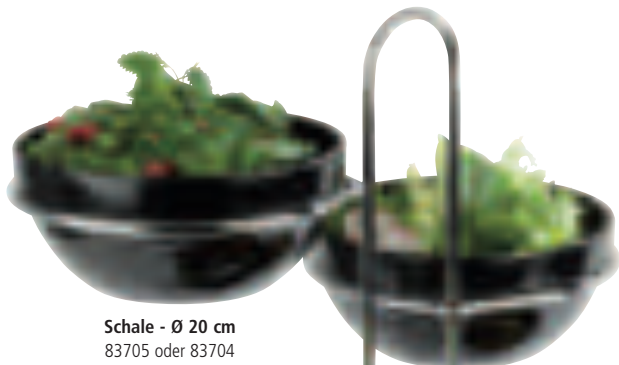

Schale - Ø 20 cm
83705 oder 83704



Gestell
4 x Ø 20 cm
33245



4 x Ø 14 cm

Gestell
4 x Ø 20 cm
33245

Etagère „CASUAL“
etagère
expositor de bombones o bocaditos
présentoir à mignardises



inkl. Schild
 incl. sign
 incluida la inscripción
 avec inscription

| | □ cm | ↑ cm | |
|---------|----------------|------|---|
| 34248 4 | Ø 31 - 41 - 51 | 55 | 3-stufig / 3-tier 3 niveles / 3 étages |
| 34247 7 | Ø 31 - 41 | 35 | 2-stufig / 2-tier 2 niveles / 2 étages |



3-stufig / 3-tier

einsteckbares Edstahlschild,
 beschriftbar (Schild ist nicht beschriftet)



2-stufig / 2-tier



Fischplatte „CASUAL“
fish platter
fuelle pescado
plat à poisson



| | □ cm | ↑ cm | |
|---------|-------------|------|--|
| 83995 3 | 28,0 x 17,0 | 2,5 | |
| 83997 7 | 48,0 x 22,5 | 2,5 | |



0,6 ltr.
 1,2 ltr.

Fischschale „CASUAL“
fish bowl
cuenco para pescado
plat creux à poisson



| | □ cm | ↑ cm | litr. |
|---------|---------|------|-------|
| 83991 5 | 24 x 27 | 5,5 | 0,6 |
| 83993 9 | 30 x 35 | 7,5 | 1,2 |

Fischplatte „BIG“
fish plate
cuenco para pescado
plat creux à poisson



| | □ cm | ↑ cm | ltr. |
|---------|-------------|------|------|
| 83996 0 | 58,5 x 28,0 | 5,5 | 2,0 |



Schale „BOAT“
bowl
cuenco
bol



| | □ cm | ↑ cm | ltr. |
|---------|-------------|------|------|
| 84037 9 | 21,5 x 13,0 | 5,0 | 0,45 |
| 84038 6 | 29,0 x 18,5 | 7,5 | 1,50 |



84037

Tablett / Sushiboard
sushi board
bandeja
plateau



| | □ cm | ↑ cm | |
|---------|-------------|------|---|
| 84980 8 | 24,0 x 10,5 | 2,5 | ○ |
| 84981 5 | 24,0 x 10,5 | 2,5 | ● |



84980

Schale „LEAF“
bowl
cuenco
bol



| | □ cm | ↑ cm | ltr. | |
|---------|-------------|------|------|---|
| 84200 7 | 42,0 x 19,5 | 6,5 | 1,0 | ○ |
| 84202 1 | 50,0 x 23,0 | 7,5 | 1,5 | ○ |
| 84201 4 | 42,0 x 19,5 | 6,5 | 1,0 | ● |
| 84203 8 | 50,0 x 23,0 | 7,5 | 1,5 | ● |



**Schale „SCANTIC“
bowl
cuenco
bol**

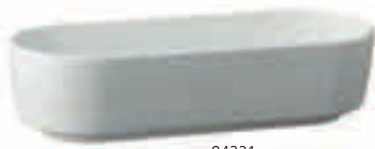

84221

| | cm | cm | litr. |
|---------|-------------|-----|-------|
| 84221 2 | 26,5 x 10,5 | 6,5 | 1 |
| 84222 9 | 53,0 x 10,5 | 6,5 | 2 |

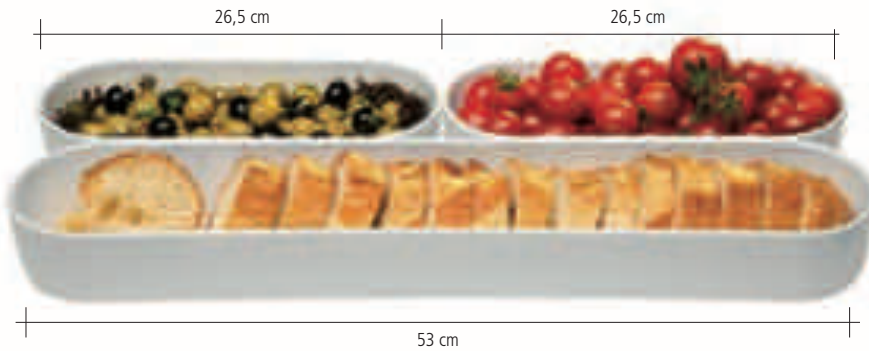

84215

84216

**Schale „CASUAL“
bowl
cuenco
bol**



| | cm | cm | litr. |
|---------|------|-----------|-------|
| 84215 1 | Ø 10 | 6,5 / 8,5 | 0,2 |
| 84216 8 | Ø 12 | 7,5 / 9,5 | 0,3 |

**Schale „PALMA“
bowl
cuenco
bol**

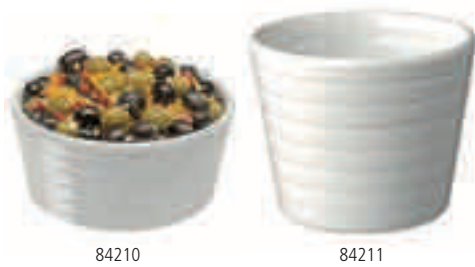

84210

84211

mit rutschfestem Boden
with non-slip bottom
con pies antideslizantes
pieds anti-dérapants

| | cm | cm | litr. |
|---------|------|------|-------|
| 84210 6 | Ø 14 | 6,5 | 0,60 |
| 84211 3 | Ø 13 | 10,5 | 0,75 |

**Dipschale „CASUAL“
bowl
cuenco
plateau**



| | cm | cm |
|---------|------------|-----|
| 84220 5 | 29,0 x 9,0 | 3,0 |



83878



83879

Fingerfood-Teller „FLYING BUFFET“
plate
plato
plato
assiette



| | cm | cm | |
|---------|-----------|-----------|---|
| 83878 9 | 9,5 x 9,5 | 1,5 / 3,5 | ○ |
| 83879 6 | 9,5 x 9,5 | 1,5 / 3,5 | ● |

Einzelteile / spare parts / piezas sueltas / pièces détachées

Edelstahl Tablett / stainless steel platter / bandeja / plateau

11119 6 53 x 32,5

Tablett „APART“ / tray / bandeja / plateau

83828 4 53,0 x 32,5 2,5

Schale „FLOAT“ / bowl / cuenco / saladier

83912 0 9,0 x 9,0 4,5 ○ 0,16

Schale „FLOAT“ / bowl / cuenco / saladier

83913 7 9,0 x 9,0 4,5 ● 0,16

passend für 15 Fingerfoodteller
oder 15 Schalen (83912 oder 83913)



Edelstahl Tablett
GN1/1
11119

stainless tray
GN1/1
11119

Melamin Tablett
GN1/1
83828

melamin tray
GN1/1
83828

designed by EsserDesign



Schale „ORGANIC“
bowl
cuenco
bol



| | cm | cm | ltr. | |
|---------|-----------|-----|------|---|
| 84235 9 | 32,5 x 17 | 5,5 | 1 | ○ |
| 84236 6 | 50,0 x 26 | 6,5 | 3,5 | ○ |
| 84237 3 | 32,5 x 17 | 5,5 | 1 | ● |
| 84238 0 | 50,0 x 26 | 6,5 | 3,5 | ● |



84235

84238

**Schale „BIG WAVE“
bowl
cuenco
bol**



| | ▣ cm | ↑ cm | ltr. |
|---------|-------------|------|------|
| 83587 0 | 33,0 x 24,0 | 8,5 | 1 |

**Schale
bowl
cuenco
bol**



0,45 und 0,80 Liter

| | ▣ cm | ↑ cm | ltr. |
|---------|-------------|------|------|
| 84028 7 | 21,0 x 14,5 | 9 | 0,45 |
| 84029 4 | 26,5 x 16,5 | 12 | 0,80 |

**Besteck-Ablage
cutlery rest
reposa cuchara
pose-cuillère**



mit rutschfestem Boden
with non-slip bottom
con pies antideslizantes
pieds anti-dérapants



| | ▣ cm | ↑ cm |
|---------|---------|------|
| 83897 0 | 26 x 13 | 4,5 |

Tablett „GOURMET“
tray
bandeja
plateau



mit 3 Absätzen Ø 4 cm
with 3 holes Ø 4 cm
con 3 agujeros Ø 4 cm
avec 3 trous Ø 4 cm

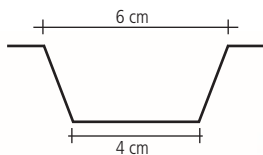

| | cm | cm | cm |
|---------|------------|-----|----|
| 84017 1 | 30,5 x 9,5 | 2,5 | |



Schälchen „GOURMET“
bowl
cuenco
bol



| | cm | cm | ml |
|---------|-----|----|----|
| 84018 8 | Ø 7 | 6 | 50 |



passend für Tablett
„Gourmet“
Nr. 84017

designed by **CULTURE FORM**

Serviertablett „KAFFEEHAUS“
tray
bandeja
tablette



rutschfeste Oberfläche
non-slip surface
superficie anti-deslizante
surface anti-dérapante

| | cm | cm | |
|---------|-------------|-----|---|
| 84250 2 | 26,0 x 20,0 | 1,5 | ○ |
| 84252 6 | 28,5 x 21,5 | 1,5 | ○ |
| 84251 9 | 26,0 x 20,0 | 1,5 | ● |
| 84253 3 | 28,5 x 21,5 | 1,5 | ● |





Tortenplatte
cake tray
bandeja para tarta
plat à tarte

Rand fixiert die Haube, mit Antirutsch-Füßchen
 carved edge fixes the cover, non-slip feet
 ranura para fijar bien la campana, pies antideslizantes
 bord rainuré pour maintien ferme de la cloche, pieds anti-glisse



Ø 31 cm - 00468



Ø 31 cm - 00469



06510

| | □ cm | ↑ cm | |
|---------|------|------|---|
| 00468 9 | Ø 31 | 4 | ○ |
| 00469 6 | Ø 31 | 4 | ● |

Einzelteile / spare parts / piezas sueltas / pièces détachées



Frischhalte-Haube / cover / campana / cloche

| | | | |
|---------|------|------|--|
| 06510 9 | Ø 30 | 11,5 | |
| 06511 6 | Ø 30 | 11,5 | schwarzer Griff / black handle botón negro / bouton noir |
| 06512 3 | Ø 30 | 11,5 | mit verchromtem Griff chrom plated handle botón cromado bouton chromé |



Servierplatte
plate
bandeja para servir
plat de service

mit Antirutsch-Füßchen
 non-slip feet
 con pies antideslizantes
 avec pieds anti-dérapants



Ø 38 cm

| | □ cm | ↑ cm | |
|---------|------|------|---|
| 83869 7 | Ø 38 | 2,5 | ○ |

Einzelteile / spare parts / piezas sueltas / pièces détachées



Rolltop-Haube / rolltop cover / campana abatible / cloche basculante

| | | | |
|---------|------|----|---|
| 18388 9 | Ø 38 | 20 | mit verchromtem Kugelgriff chrome plated handle pomo cromado bouton chromé |
|---------|------|----|---|



18388



83890

↑ 8 cm



83891

↑ 16 cm

Servier- und Tortenplatte „CASUAL“
 cake plate
 porta pateles
 présentoir à gâteaux



| | □ cm | ↑ cm |
|---------|------|------|
| 83890 1 | Ø 31 | 8 |
| 83891 8 | Ø 31 | 16 |



83890



83892

↑ 8 cm



83893

↑ 16 cm

Servier- und Tortenplatte „CASUAL“
 cake plate
 porta pateles
 présentoir à gâteaux



| | □ cm | ↑ cm |
|---------|---------|------|
| 83892 5 | 31 x 31 | 8 |
| 83893 2 | 31 x 31 | 16 |



83893

designed by sieger design



GN 1/1 - 1/2 - 1/3

84046

Tablett „FRAMES“
 tray
 bandeja
 plat



| | □ cm | ↑ cm | GN |
|---------|-------------|------|-----|
| 84046 1 | 53,0 x 32,5 | 2 | 1/1 |
| 84047 8 | 32,5 x 26,5 | 2 | 1/2 |
| 84048 5 | 32,5 x 17,6 | 2 | 1/3 |

NEW

Eierbecher, 4er Set
egg holder, 4 pcs. set
huevera, set de 4 unidades
coquetier, pack de 4



| | □ cm | ↑ cm | pcs. |
|---------|------|------|------|
| 83851 2 | Ø 8 | 3 | 4 |

Eierbecher, 4er Set
egg holder, 4 pcs. set
huevera, set de 4 unidades
coquetier, pack de 4



| | □ cm | ↑ cm | pcs. |
|---------|-------|------|------|
| 83848 2 | Ø 8,5 | 2 | 4 |

Teller, rund „CASUAL“
plate, round
plato redondo
assiette ronde



| | □ cm | ↑ cm |
|---------|--------|------|
| 83500 9 | Ø 22,5 | 2,5 |
| 83514 6 | Ø 26,5 | 2,5 |

Kaffeebecher „CASUAL“
coffee cup
taza de café
tasse à café



| | □ cm | ↑ cm | ltr. |
|---------|-------|------|------|
| 83513 9 | Ø 9,5 | 10 | 0,4 |

FRUITS designed by EsserDesign



83951



83952



83953



83954

Schale „FRUITS“ bowl cuenco saladier FRUITS



innen weiß
white inside
interior blanco
intérieur blanc

| | cm | cm | ltr. | |
|---------|------|-----|------|---|
| 83951 9 | Ø 15 | 7,5 | 0,45 | außen Erdbeer-Dekor outside strawberry decor exterior motivo de fresa extérieur motif fraise |
| 83952 6 | Ø 15 | 7,5 | 0,45 | außen Orangen-Dekor outside orange decor exterior motivo de naranja extérieur motif orange |
| 83953 3 | Ø 15 | 7,5 | 0,45 | außen Zitronen-Dekor outside lemon decor exterior motivo de limón extérieur motif citron |
| 83954 0 | Ø 15 | 7,5 | 0,45 | außen Kiwi-Dekor outside kiwi decor exterior motivo de kiwi extérieur motif kiwi |



3,3 ltr.
83968
ohne Dekor



3,3 ltr.
83969
ohne Dekor

Schale „FRUITS“ bowl cuenco saladier FRUITS



innen weiß
white inside
interior blanco
intérieur blanc

| | cm | cm | ltr. | |
|---------|------|----|------|---|
| 83968 7 | Ø 28 | 14 | 3,3 | außen rot / outside red exterior rojo / extérieur rouge uni |
| 83969 4 | Ø 28 | 14 | 3,3 | außen grün / outside green exterior verde / extérieur vert uni |

FINGERFOOD LÖFFEL

PARTY SPOON / CUCHARA PARTY / CUILÈRE PARTY



NEW



Löffel „HALFTONE“
spoon
cuchara
cuillère



| | □ cm | ↑ cm | | |
|---------|-------|------|---|---------------|
| 84158 1 | Ø 5,5 | 7 | ● | white / black |



84128

Fingerfood Löffel „BOAT“
party spoon
cuchara party
cuillère party



| | □ cm | ↑ cm | | |
|---------|------------|------|---|---------------|
| 84128 4 | 14,5 x 4,5 | 4,5 | ● | white / black |
| 84140 6 | 14,5 x 4,5 | 4,5 | ○ | white |
| 84141 3 | 14,5 x 4,5 | 4,5 | ● | black |
| 84142 0 | 14,5 x 4,5 | 4,5 | ● | lemon-green |
| 84143 7 | 14,5 x 4,5 | 4,5 | ● | mint |



84143

84142

84140

84141

84128



Fingerfood-Löffel „HONG KONG“
party spoon
cuchara party
cuillère party



| | ☐ cm | ↑ cm | |
|---------|----------|------|---|
| 83486 6 | 13 x 4,5 | 4,5 | ○ |
| 83487 3 | 13 x 4,5 | 4,5 | ● |
| 83424 8 | 13 x 4,5 | 4,5 | ● |
| 83426 2 | 13 x 4,5 | 4,5 | ● |

designed by **EsserDesign**



Fingerfood-Löffel „MING HING“
party spoon
cuchara party
cuillère party



| | ☐ cm | ↑ cm | |
|---------|----------|------|---|
| 83842 0 | 11 x 4,5 | 4 | ○ |
| 83843 7 | 11 x 4,5 | 4 | ● |

designed by **EsserDesign**



Fingerfood-Löffel „YING YANG“
party spoon
cuchara party
cuillère party



| | ☐ cm | ↑ cm | |
|---------|----------|------|---|
| 83844 4 | 10 x 4,5 | 1,5 | ○ |
| 83845 1 | 10 x 4,5 | 1,5 | ● |

designed by **formel²³**
PRODUKTDESIGN



Fingerfood-Löffel „LEAF“
party spoon
cuchara party
cuillère Party



| | ☐ cm | ↑ cm | |
|---------|----------|------|---|
| 83887 1 | 10 x 4,5 | 1,5 | ○ |
| 83888 8 | 10 x 4,5 | 1,5 | ● |
| 83889 5 | 10 x 4,5 | 1,5 | ● |



Fingerfood-Löffel „FISH“
party spoon
cuchara party
cuillère party



| | ☐ cm | ↑ cm | |
|---------|------------|------|--|
| 83850 5 | 10,5 x 4,5 | 2,5 | |

NEW

HOT PRICE

Dressinglöffel
dressing spoon
cuchara de aliño
cuillère à sauce

SAN
KUNSTSTOFF



| | cm | → cm | |
|---------|-----|------|---|
| 88636 0 | Ø 6 | 34 | ○ |
| 88609 4 | Ø 6 | 34 | ● |

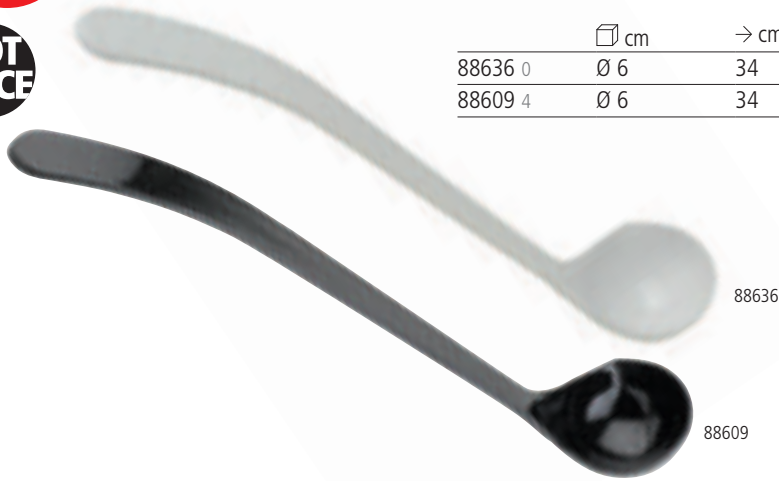

Dressingtopf „CASUAL“
dressing pot
salsera alta
saucière

MF
MELAMINE



| | cm | ↑ cm | ltr. | |
|---------|------|------|------|---|
| 83867 3 | Ø 12 | 21,5 | 1 | ○ |
| 83868 0 | Ø 12 | 21,5 | 1 | ● |

PROFI-QUALITY

Salat-Löffel
salad spoon
cuchara
cuillère

MF
MELAMINE



PROFI-QUALITY



| | cm | ↑ cm |
|---------|--------|------|
| 84036 2 | 24 x 7 | 4 |

Salat-Löffel
salad spoon
cuchara
cuillère

MF
MELAMINE



| | cm | ↑ cm |
|---------|--------|------|
| 84035 5 | 24 x 7 | 4,5 |

**HOT
PRICE**



Feinkostlöffel, 6er Set
delicatessen spoon, 6 pcs. set
juego de 6 cucharas gourmet
jeu de 6 cuillères gourmet

SAN
KUNSTSTOFF



| | cm | → cm | pcs. | |
|---------|-----|------|------|---------------|
| 88626 1 | ∅ 6 | 23 | 6 | ○ transparent |

**HOT
PRICE**



Feinkostlöffel, 6er Set
delicatessen spoon, 6 pcs. set
juego de 6 cucharas gourmet
jeu de 6 cuillères gourmet

SAN
KUNSTSTOFF



| | cm | → cm | pcs. | |
|---------|-----|------|------|---|
| 88627 8 | ∅ 6 | 23 | 6 | ○ |

**HOT
PRICE**



Feinkostlöffel, 6er Set
delicatessen spoon, 6 pcs. set
juego de 6 cucharas gourmet
jeu de 6 cuillères gourmet

SAN
KUNSTSTOFF



| | cm | → cm | pcs. | |
|---------|-----|------|------|---|
| 88628 5 | ∅ 6 | 23 | 6 | ● |

**HOT
PRICE**



Feinkost- / Olivenlöffel, 6er Set
delicatessen / oliven spoon, 6 pcs. set
juego de 6 cucharas para olivas
jeu de 6 cuillères à olives

SAN
KUNSTSTOFF



gelocht
perforated
perforadas
perforées

| | cm | → cm | pcs. | |
|---------|-------|------|------|---|
| 88598 1 | 6 x 9 | 27 | 6 | ● |

designed by **CULTURE FORM**



84020



84021



Servierlöffel „PROFI“
serving-spoon
cuchara
cuillère



| | cm | → cm | |
|---------|---------|------|---|
| 84020 1 | 7 x 6,5 | 26,5 | ○ |
| 84021 8 | 7 x 6,5 | 26,5 | ● |



rutschsicher /
slip-proof



gerade
Portionierkante /
easy cutting



einfach abstreifen /
simply wipe off



Tiefe Ecken? - Kein Problem!
Deep corners? No problem!



10 Schilderhalter „FLEX CLIP“
10 sign holders
pack de 10 clips
pack de 10 porte-étiquettes



Durch die bewegliche Verbindung der Klemme und Schilderhalterung ein extrem flexibler Cliphalter!

multi angle ticket clip
 inclinable con pinza
 inclinable avec pince
 → cm

| | | | |
|-------|---|------|-------------|
| 71472 | 4 | 9,5 | ○ elfenbein |
| 71473 | 1 | 12,5 | ○ elfenbein |
| 71474 | 8 | 9,5 | ● |
| 71475 | 5 | 12,5 | ● |

Zubehör / spare parts / recambios / pièces de rechange

passende Schilder, 10er Set / fitting signs, 10 pcs. set
 set de 10 cartelitos / set de 10 étiquettes

| | cm | pcs. |
|-------|-------------|------|
| 11879 | 9 7,7 x 5,2 | 10 |
| 12879 | 8 5,0 x 3,0 | 10 |



10 Beschriftungsclips, inkl. 10 Schilder
10 sign holders, with 10 signs
10 soportes + 10 cartelitos
10 supports + 10 étiquettes



| | cm | pcs. |
|-------|-----------|------|
| 71482 | 3 6 x 2,7 | 10 ○ |
| 71483 | 0 6 x 2,7 | 10 ● |

Einzelteile / spare parts / piezas sueltas / pièces détachées

passende Schilder, 10er Set / fitting signs, 10 pcs. set
 set de 10 cartelitos / set de 10 étiquettes

| | | |
|-------|-------------|----|
| 11879 | 9 7,7 x 5,2 | 10 |
|-------|-------------|----|



in 2 Längen
erhältlich

Schilderhalter „FLEXIBEL“
sign holder
soporte para cartelito
support pour menu de table



biegsamer Draht mit zwei Klemmen, extrem flexibel, die Klemmen lassen sich weit öffnen
 bedable metal coil adds visual interest, two metal clip open
 metal cromado flexible, 2 pinzas con gran apertura
 métal chromé, flexible, 2 pinces à grande ouverture

| | → cm | |
|-------|------|--|
| 71470 | 0 12 | ohne Schilder / without signs sin cartelitos / sans étiquette |
| 71471 | 7 23 | ohne Schilder / without signs sin cartelitos / sans étiquette |
| 71480 | 9 12 | inkl. 10 Schilder 11879 / incl. 10 signs 11879 con 10 cartelitos 11879 / avec 10 étiquettes 11879 |
| 71481 | 6 23 | inkl. 10 Schilder 11879 / incl. 10 signs 11879 con 10 cartelitos 11879 / avec 10 étiquettes 11879 |

BUFFET-STÄNDER KING designed by CULTURE FORM



Buffet-Ständer „KING“ buffet stand soporte para bufet présentoir buffet



kein Verrutschen, Arme und Boden sind mit Antirutschflächen ausgestattet, schwere standsichere Qualität, Fuß dient als Löffelablage

the arms and base are equipped with non-slip surfaces, stable quality, base serves as spoon holder

anti-deslizante: revestimiento antideslizante en las puntas de los brazos y en la base. Estable y alta calidad. la base sirve como reposacuchara

anti-glisse - : revêtement anti-dérapant sur les extrémités des 3 pieds et sur la base. Robuste, stable et bonne qualité. La base sert de support pour les couverts



| | cm | cm |
|---------|------|----|
| 03622 2 | Ø 15 | 14 |
| 03623 9 | Ø 15 | 21 |

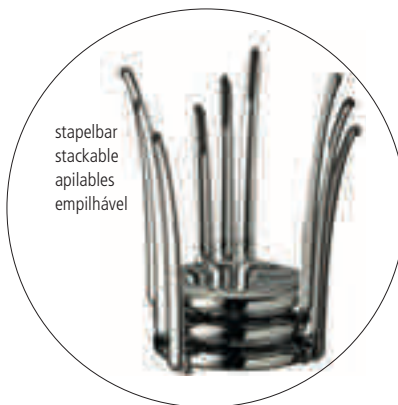

Servierartikel aus Edelstahl . Porzellan . Glas . Holz . Schiefer
serving items stainless steel . porcelain . glass . wood . slate
artículos de servicio en inox . porcelana . vidrio . madera y pizarra
pièces de service en inox . porcelaine . verre . bois et ardoise

OLIVE



Servier-Brett „OLIVE“
servicing board
Tabla de servir en madera de olivo
Planche de service en bois d'olivier



00870



00874



00876

Servierbrett im Naturschnitt, aus Olivenholz. Jedes Brett wird handgefertigt und lackiert mit 19 mm Aufhäng Bohrung. Nach Gebrauch mit lauwarmen Wasser und etwas Spülmittel abwaschen und sofort abtrocknen. Alle Produkte unterscheiden sich naturbedingt in Form, Maserung und Größe!

Olive Wood is known for its versatility and striking appearance with each piece having its own unique features. Each piece being carefully crafted by hand therefore size, shape and finish will vary from piece to piece. All sizes are approximate due to the natural variation in shape. They should be washed in warm soapy water and not to soak!

El olivo es conocido por su versatilidad y aspecto espectacular y único en cada pieza. Por su fabricación a mano de forma artesanal, todas las piezas varían en tamaño, forma y acabado, lo que hace de cada una un ejemplar único. Por la misma razón, los tamaños indicados son aproximados. Al ser de madera natural, las tablas no se deben lavar con agua caliente y jabón ni ser sumergidas en agua.

Le bois d'olivier est reconnu pour sa versatilité et son esthétique spectaculaire. De par leur fabrication artisanale à la main, toutes les pièces varient quant à leur taille, forme et finition, de telle sorte que chacune est un exemplaire unique. Pour les mêmes raisons, les dimensions indiquées sont approximatives. S'agissant de bois naturel, les planches ne doivent pas être lavées à l'eau chaude ni avec des détergents, ni être submergées.

| | cm | cm | |
|---------|-------------|-----|----------------------|
| 00870 0 | 25,0 x 17,0 | 1,5 | |
| 00871 7 | 30,0 x 20,5 | 2,0 | |
| 00872 4 | 35,0 x 24,0 | 2,0 | |
| 00873 1 | 40,0 x 15,0 | 1,5 | Griff / handle 11 cm |
| 00874 8 | 44,0 x 20,0 | 2,0 | Griff / handle 12 cm |
| 00875 5 | 19,0 x 12,5 | 1,5 | Griff / handle 6 cm |
| 00876 2 | 25,0 x 16,0 | 1,5 | Griff / handle 8 cm |
| 00877 9 | 31,0 x 20,0 | 1,5 | Griff / handle 9 cm |

designed by **CULTURE FORM**

Buffet-Brett „XXL“
board
tabla
planche



Ø 50 cm

Buchenholz geölt, mit Antirutsch-Füßchen
beech wood oiled, with non-slip feet
Madera de haya tratada con aceite, pies antideslizantes
Bois hêtre huilé, pieds anti-glisse

| | ☐ cm | ↑ cm |
|---------|------|------|
| 00866 3 | Ø 50 | 4,5 |

passende Rolltophaube / suitable rolltop cover / campana abatible / cloche basculante

| | | |
|---------|------|----|
| 18380 3 | Ø 50 | 26 |
|---------|------|----|

18380



00866

designed by **CULTURE FORM**

Buffet-Brett
board
tabla para el buffet
planche à découper buffet



11016

00865

Buchenholz, mit Antirutsch-Füßchen
beech wood, with non-slip feet
haya, pies antideslizantes
hêtre, pieds anti-dérapants

| | ☐ cm | ↑ cm |
|---------|---------|------|
| 00865 6 | 58 x 38 | 2,5 |

passende Rolltophaube / suitable rolltop cover / campana abatible / cloche basculante

| | ☐ cm | ↑ cm | Seite/page |
|---------|-------------|------|------------|
| 11016 8 | 53 x 32,5 | 19 | 449 |
| 11008 3 | 53 x 32,5 | 19 | 449 |
| 11010 6 | 53,0 x 32,5 | 19 | 449 |



Griffmulde

SNACK-HOLDER

Originelles Servieren



Servier-Frittierkorb „SNACK-HOLDER“ stainless steel fry baskets cestitas inox para el servicio mesa paniers inox pour le service sur table



Die Mini-Edestahlkörbchen dienen dem portionsweisen Servieren.
Zum originellen Servieren von Beilagen geeignet, aber auch zum Frittieren selbst.

The mini frying baskets are used to present individual portions in an original way, but can still be used to fry

Las cestas de freir ofrecen una presentación original para el servicio de tapas o raciones individuales de patatas, aperitivos, fritos, etc. También se pueden usar para freir

Les paniers à friture offrent une présentation originale pour servir apéritifs, snacks, tapas et autres rations individuelles. Également aptes pour frire

| | □ cm | ↑ cm | Griff cm |
|---------|-------------|------|----------|
| 40600 1 | Ø 8 | 7,5 | 9,5 |
| 40601 8 | Ø 9 | 8,5 | 9,0 |
| 40610 0 | 21,5 x 10,5 | 4,5 | 9,5 |
| 40611 7 | 26 x 13 | 5,0 | 9,5 |
| 40620 9 | 10,0 x 8,5 | 6,5 | 9,0 |
| 40621 6 | 13,0 x 10,5 | 9,0 | 13,5 |



Servier- / Saucen-Eimer „SNACK-HOLDER“
mini stainless steel bucket
cubo inox en formato mini
seau mini inox



| | □ cm | ↑ cm | ltr. | pcs. |
|---------|------|------|------|------|
| 40630 8 | Ø 7 | 6,5 | 0,15 | 4 |
| 40631 5 | Ø 9 | 8,5 | 0,33 | 1 |



40630
4er Set

40631
1 Stk. / 1 pc.

40630
4er Set



Mini-Milchkanne „SNACK-HOLDER“
mini milk can
lechera en formato mini
pot à lait mini



| | □ cm | ↑ cm | ltr. | pcs. |
|---------|-------|------|------|------|
| 40640 7 | Ø 4,5 | 5 | 0,08 | 4 |
| 40641 4 | Ø 7,5 | 9,5 | 0,45 | 1 |



40640
4er Set

40641
1 Stk. / 1 pc.

40640
4er Set



Mini-Seiher „SNACK-HOLDER“
mini colander
colador en formato mini
passoire mini



| | □ cm | ↑ cm |
|---------|------|------|
| 40650 6 | Ø 10 | 6 |
| 40651 3 | Ø 13 | 6 |

40650

40651



Mini-Servierpfanne „SNACK-HOLDER“
mini pan
sartén en formato mini
poêle à frire mini



| | □ cm | ↑ cm | ltr. |
|---------|------------|-----------|------|
| 40660 5 | 14,5 x 9,5 | 4,5 / 6,5 | 0,5 |

SNACK HOLDER

Originelles Servieren



NEW

Snack Holder
serving cup
sirve el vaso
sers le gobelet



| | □ cm | ↑ cm | ltr. | |
|---------|-------|------------|------|-----------------------------------|
| 40605 6 | Ø 9,5 | 8,5 / 11,5 | 0,35 | |
| 40606 3 | Ø 8,5 | 8,5 | 0,3 | |
| 40607 0 | Ø 8,5 | 8,5 | 0,3 | gehämmerte Oberfläche hammered |



40605



40606



40607
gehämmerte Oberfläche
hammered



Wachspapier „SNACK-HOLDER“, 500 Stck.
greaseproof paper squares, 500 pcs.
papel alimenticio para cucurucho, 500 pz.
papier alimentaire pour cornet, 500 pc.

| | cm | pcs. | |
|---------|---------|------|--------------------|
| 40670 4 | 42 x 25 | 500 | Motiv: Zeitung |
| 40671 1 | 42 x 25 | 500 | blank |
| 40672 8 | 42 x 25 | 500 | Motiv: rote Karos |
| 40673 5 | 42 x 15 | 500 | Motiv: blaue Karos |

NEW

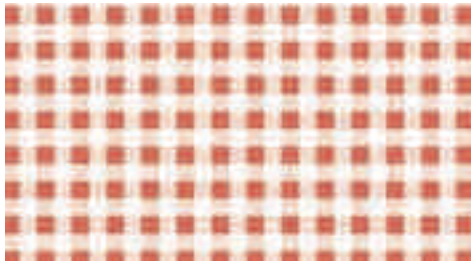

40672

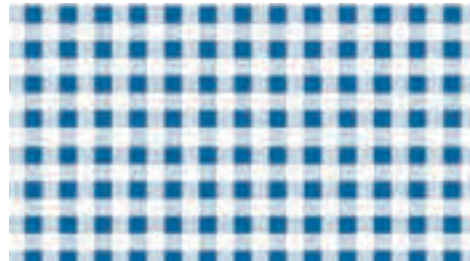

40673



40672

00536



6 Löffel

Gourmetlöffel, 6er Set
gourmet spoons, 6 pcs. set
cucharas gourmet, el pack de 6
cuillères gourmet, le pack de 6



hochglanzpoliert, zur Präsentation von Vorspeisen
mirror polished finish, perfect to present appetiser
acabado brillante, perfecto para presentar aperitivos
poli brillant, parfait pour les apéritifs et entrées

| | cm | pcs. |
|---------|--------|------|
| 00682 9 | 11 x 4 | 6 |



6er Set:
3 stehende + 3 liegende Gabeln

Canapee-Gabeln, 6er Set
canapé forks, 6 pcs. set
tenedores canapé, el pack de 6
fourchettes a canapés, le pack de 6



6-teilig: 3 stehende Gabeln 7 x 3 x 4 cm + 3 liegende Gabeln 11,5 x 2,5 x 1,5 cm
6 pcs. set: 3 forks standing 7 x 3 x 4 cm + and 3 forks lying 11,5 x 2,5 x 1,5 cm
set de 6 piezas: 3 tenedores de pie, 7 x 3 x 4 cm + tres tenedores tumbados, 11,5 x 2,5 x 1,5 cm
Set 6 pièces: 3 fourchettes 7x3x4 cm +3 fourchettes 11,5x2,5x1,5 cm

| | pcs. |
|---------|------|
| 16905 0 | 6 |

NATURSCHIEFER



rutschfeste,
möbelschonende
Füßchen

GN 1/1
00990



GN 1/2
00991

GN 1/3
00992



GN 1/4
00993

Naturschieferplatten GN natural slate tray GN bandeja de pizarra natural GN plat ardoise naturelle GN



hervorragende Kältespeicherung durch Naturschiefer, um die typische Struktur des Materials hervorzuheben sind die Kanten der Platten gebrochen und nicht gesägt

excellent coldness store, food safe, waterproof

excelente conservador del frio, para reforzar la estética natural, los bordes ofrecen un canto irregular

excellent maintien du froid, les bords sont volontainement cassés pour renforcer l'esthétique naturelle

| | cm | mm | GN |
|---------|-------------|-------|-----|
| 00990 5 | 53,0 x 32,5 | 5 - 8 | 1/1 |
| 00991 2 | 32,5 x 26,5 | 4 - 7 | 1/2 |
| 00992 9 | 32,5 x 17,6 | 4 - 7 | 1/3 |
| 00993 6 | 26,5 x 16,2 | 4 - 7 | 1/4 |
| 00973 8 | 53,0 x 16,2 | 4 - 7 | 2/4 |



Naturschieferplatte rechteckig natural slate tray rectangular bandeja de pizarra natural rectangular plat ardoise naturelle rectangulaire



| | cm | mm |
|---------|---------|-------|
| 00996 7 | 45 x 30 | 4 - 7 |



Naturschieferplatte quadratisch natural slate tray square bandeja de pizarra natural cuadrada plat ardoise naturelle carré



| | cm | mm |
|---------|---------|-------|
| 00994 3 | 25 x 25 | 4 - 7 |
| 00995 0 | 30 x 30 | 4 - 7 |



Tortenplatte / Servierplatte Drehbar
Cake stand
sporte para pastel
présentoir à gâteaux



| | □ cm | ↑ cm |
|---------|------|------|
| 00975 2 | Ø 32 | 2,5 |

drehbar



Naturschieferplatten rund
natural slate tray round
bandeja de pizarra natural redonda
plat ardoise naturelle rond



| | □ cm | ✱ mm |
|---------|------|-------|
| 00968 4 | Ø 22 | 4 - 7 |
| 00969 1 | Ø 28 | 4 - 7 |
| 00998 1 | Ø 33 | 4 - 7 |
| 00999 8 | Ø 38 | 4 - 7 |

00968



2-stufige Etagère
2 tier tray
bandeja dos alturas
plat carré 2 hauteurs



| | □ cm | ↑ cm | ✱ mm |
|---------|-----------|------|-------|
| 00989 9 | Ø 25 / 20 | 24 | 4 - 7 |

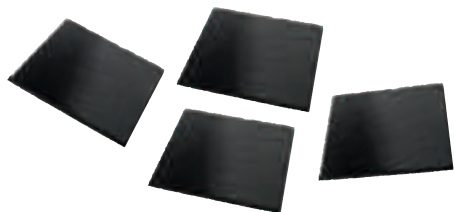

Naturschieferplatten, 4er Set
natural slate tray, 4 pcs. set
set de 4 piezas, pizarra natural
set de 4 pièces, ardoise naturelle



| | □ cm | ✱ mm |
|---------|---------|-------|
| 00997 4 | 10 x 10 | 4 - 7 |



Buffet-Set, 3-teilig
rolltop-set, 3 pcs.
set roll top 3 piezas
set rolltop 3 pièces



1 Edelmetalltablett Ø 38 cm + 1 Naturschieferplatte Ø 33 cm + 1 Rolltop-Haube Ø 38 cm

1 stainless tray Ø 38 cm + 1 natural slate tray Ø 33 cm + 1 rolltop cover Ø 38 cm

Bandeja de acero inoxidable Ø 38 cm + 1 bandeja de pizarra natural Ø 33 cm + 1 tapa abatible Ø 38 cm

plat inox 38 cm + plat ardoise naturelle 33 cm + cloche 38 cm

| | □ cm | ↑ cm |
|---------|------|------|
| 01000 0 | Ø 38 | 24 |



00941



00945



00942

Naturschieferplatte
natural slate
bandejas de pizarra natural
plateau ardoise naturelle



| | cm | mm |
|---------|-------------|----|
| 00941 7 | 24,0 x 15,0 | 5 |
| 00945 5 | 47,0 x 10,0 | 5 |
| 00942 4 | 26,5 x 20,5 | 5 |
| 00988 2 | 30,0 x 12,0 | 5 |

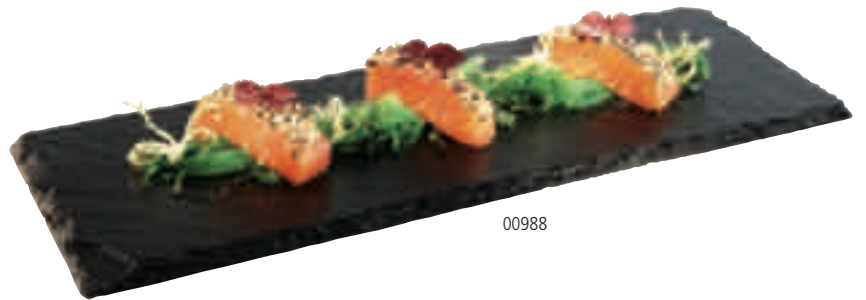

00988

„Highlight Präsentation“
Schieferplatten einlegbar
in Melamintabletts

Melamintablett GN2/4 83433
Schieferplatte 00945

Melamintablett 83417
Schieferplatte 00941

Melamintablett GN1/2 83480
Schieferplatte 00942

Melamintablett 83403
Schieferplatte 00988

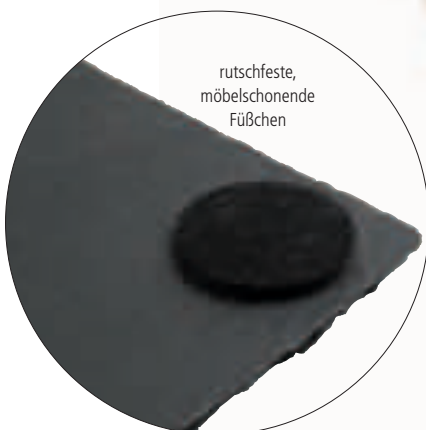

rutschfeste,
möbelschonende
Füßchen

2 Absätze
Ø 6 cm



Salzmühle
40541



Pfeffermühle
40540

Naturschieferplatte / Untersetzer
natural slate tray
bandeja pizarra natural
plat ardoise naturelle



mit 2 Absätzen Ø 6 cm
with 2 holes Ø 6 cm
con 2 agujeros Ø 6 cm
avec 2 trous Ø 6 cm

| | cm | mm |
|---------|--------|-------|
| 00971 4 | 15 x 8 | 4 - 7 |



Weck-Glas
220 ml - 82316



Naturschieferplatte, 2-teilig
natural slate tray, 2 pcs. set
bandeja de pizarra natural y campana
plateau ardoise naturelle et cloche en verre



mit Glashaube
with glass cover
con tapa de cristal
avec cloche en verre

| | cm | cm | mm |
|---------|--------|----|-------|
| 00984 4 | Ø 10,5 | 8 | 4 - 7 |



Naturschieferplatte
natural slate tray
bandeja pizarra natural
plat ardoise naturelle



mit Absatz Ø 5,5 cm
with hole Ø 5,5 cm
con agujero, Ø 5,5 cm
avec trou diam. 5,5 cm

| | cm | mm |
|---------|---------|-------|
| 00986 8 | 25 x 12 | 4 - 7 |



Weck-Gläser
82310, 82312 und 82314

Naturschieferplatte
natural slate tray
bandeja pizarra natural
plat ardoise naturelle



mit 3 Absätzen, Ø 5,5 cm
with 3 holes, Ø 5,5 cm
con 3 agujeros, Ø 5,5 cm
avec 3 trous diam. 5,5 cm

| | cm | mm |
|---------|---------|-------|
| 00987 5 | 28 x 10 | 4 - 7 |

GASTRONORM SPIEGELPLATTEN

GN MIRROR GLASS PLATTER / ESPEJOS GN / MIROIRS GN

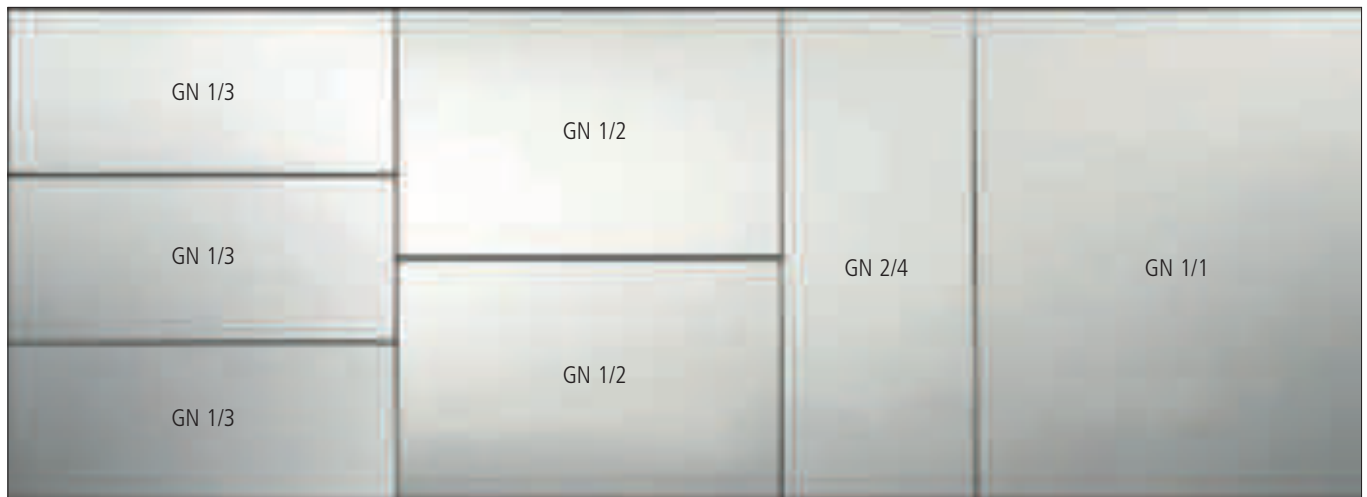

Glasplatte „MIRROR SILVER“ glass platter espejos sobre vidrio plateau miroir en verre



silber spiegelndes Glas, mit Antirutsch-Füßchen
silver mirror glas, non-slip feet
espejo plateado, pies antideslizantes
plateau miroir argenté, pieds anti-glisse



| | ▣ cm | ↑ cm | GN |
|---------|-------------|------|-----|
| 00961 5 | 53 x 32,5 | 3 | 1/1 |
| 00962 2 | 32,5 x 26,5 | 3 | 1/2 |
| 00963 9 | 32,5 x 17,6 | 3 | 1/3 |
| 00964 6 | 53 x 16,2 | 3 | 2/4 |



Glasplatte „MIRROR BLACK“ glass platter bandeja espejo negro en vidrio plateau miroir noir en verre



schwarz spiegelndes Glas, mit Antirutsch-Füßchen
black mirror glas, non-slip feet
bandeja espejo negro, pies antideslizantes
plateau miroir noir en verre, pieds anti-glisse

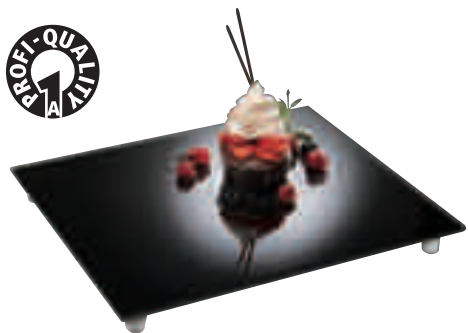

| | ▣ cm | ↑ cm | GN |
|---------|-------------|------|-----|
| 00929 5 | 53 x 32,5 | 3 | 1/1 |
| 00930 1 | 32,5 x 26,5 | 3 | 1/2 |
| 00931 8 | 32,5 x 17,6 | 3 | 1/3 |
| 00932 5 | 53 x 16,2 | 3 | 2/4 |

Welle / Wave / ola / vague

| | | | |
|---------|-----------|---|-----|
| 00985 1 | 53 x 32,5 | 3 | 1/1 |
|---------|-----------|---|-----|

rund / round / redondo / rond

| | | | |
|---------|------|---|--|
| 00983 7 | Ø 50 | 3 | |
|---------|------|---|--|



matt poliert
35930

35735
hochglanzpoliert

Plattteller
plate tray
bajo plato
assiette de présentation



Rand eingerollt
rolled edge
borde redondeado
bord rond

| | cm | |
|---------|------|--|
| 35930 7 | Ø 31 | matt poliert / satin polished finish acabado efecto satinado / fini mat effet satin |
| 35735 8 | Ø 31 | hochglanzpoliert / satin polished finish acabado efecto satinado / fini mat effet satin |



Fadendekor

Plattteller
plate tray
bajo plato
assiette de présentation



hochglanzpoliert, mit Fadendekor
mirror polished finish, with line edge
pulido efecto espejo, con un filo en relieve
poli miroir, filet relief

| | cm | |
|---------|--------|--|
| 35730 3 | Ø 30,5 | |
| 36233 8 | Ø 33 | |



Perlrand

Plattteller
plate tray
bajo plato
assiette de présentation



hochglanzpoliert, mit Perlrand
mirror polished finish, with pearl edge
acabado pulido efecto espejo, con borde aperlado
poli miroir, bord perlé

| | cm | |
|---------|--------|--|
| 35720 4 | Ø 30,5 | |
| 36323 6 | Ø 33 | |



Glocke
cloche / dome cover
campana esférica
cloche demi-sphère



außen hochglanzpoliert, innen matt poliert, mit verchromten Griff
outside mirror polished finish, inside satin polished finish, with chromeplated handle
exterior pulido acabado efecto espejo, interior pulido acabado efecto satinado, pomo cromado
extérieur poli brillant, intérieur poli satin

| | cm | ↑ cm |
|---------|------|------|
| 35734 1 | Ø 29 | 18 |

ORIGINAL WECK



Weck-Flaschen, 6er Set
Weck-bottles
Weck-botellas
Weck-bouteilles

6 Flaschen + 6 Deckel
 6 bottles + 6 covers
 6 botellas + 6 tapas
 6 bouteilles + 6 couvercles



| | ☐ cm | ↑ cm | ltr. | pcs. |
|---------|-------|------|------|------|
| 82307 5 | Ø 6,5 | 14,5 | 0,25 | 6 |



Weck-Flaschen, 6er Set
Weck-bottles
Weck-botellas
Weck-bouteilles

6 Flaschen + 6 Deckel
 6 bottles + 6 covers
 6 botellas + 6 tapas
 6 bouteilles + 6 couvercles



| | ☐ cm | ↑ cm | ltr. | pcs. |
|---------|-------|------|------|------|
| 82308 2 | Ø 6,5 | 19 | 0,5 | 6 |



Weck-Flaschen, 6er Set
Weck-bottles
Weck-botellas
Weck-bouteilles

6 Flaschen + 6 Deckel
 6 bottles + 6 covers
 6 botellas + 6 tapas
 6 bouteilles + 6 couvercles



| | ☐ cm | ↑ cm | ltr. | pcs. |
|---------|-------|------|------|------|
| 82309 9 | Ø 6,5 | 25,5 | 1,0 | 6 |



82310
80 ml

Weck-Gläser mit Deckel, 12er Set
Weck-glasses with lid
pack de 12 tarros de vidrio con tapa
pack de 12 pots en verre avec couvercle



12 Gläser + 12 Deckel
 12 glasses + 12 cover
 12 vasos + 12 tapas
 12 verrines + 12 couvercles



82312
140 ml



NEW

| | □ cm | ↑ cm | ltr. | pcs. |
|---------|------|------|------|------|
| 82310 5 | Ø 6 | 5,5 | 0,08 | 12 |
| 82312 9 | Ø 6 | 7,0 | 0,14 | 12 |
| 82314 3 | Ø 6 | 8,0 | 0,16 | 12 |
| 82345 7 | Ø 9 | 6,0 | 0,20 | 12 |
| 82316 7 | Ø 7 | 8,0 | 0,22 | 12 |



82314
160 ml



82316
220 ml



82345
200 ml

Servierartikel
 serving items



passende Gläser:
 82310, 82312
 oder 82314

Gestell - 12 x Ø 6 cm
 33246
 ohne Gläser
 without glasses

Serviergestell „WECK“
serving stand
expositor
présentoir



| | □ cm | ↑ cm | |
|---------|------|------|-------------|
| 33247 8 | Ø 22 | 33 | 6 x Ø 6 cm |
| 33246 1 | Ø 22 | 59 | 12 x Ø 6 cm |



Sturz-Form
 (80 ml)

Gestell - 6 x Ø 6 cm
 33247
 ohne Gläser
 without glasses

NEW



Weck-Gläser mit Deckel, 3er Set
Weck-glasses with lid, 3 pcs.
pack de 3 tarros de vidrio con tapa, 3 pz.
pack de 3 pots en verre avec couvercle, 3pc.

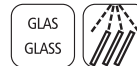

3 Gläser + 3 Deckel
3 glasses + 3 cover
3 vasos + 3 tapas
3 verrines + 3 couvercles

| | cm | cm | ltr. | pcs. |
|---------|------|-----|------|------|
| 82346 4 | Ø 11 | 7,5 | 0,37 | 3 |

NEW



Weck-Gläser mit Deckel, 2er Set
Weck-glasses with lid, 2 pcs.
pack de 2 tarros de vidrio con tapa, 2 pz.
pack de 2 pots en verre avec couvercle, 2 pc.



2 Gläser + 2 Deckel
2 glasses + 2 cover
2 vasos + 2 tapas
2 verrines + 2 couvercles

| | cm | cm | ltr. | pcs. |
|---------|------|----|------|------|
| 82347 1 | Ø 11 | 11 | 0,58 | 2 |

NEW



Weck-Frischhaltedeckel, 5er Set
airtight cover, 5 pcs.
tapa hermética, 5 pz.
couvercle hermétique, 5 pc.



für Rundrandgläser Ø 6 cm, 5er Set
for Ø 6 cm glasses, 5 pcs. set
vasos Ø 6 cm, 5 pt.
verrines Ø 6 cm, set de 5

| | cm | pcs. | matches |
|---------|-----|------|--|
| 82338 9 | Ø 7 | 5 | for all glasses Ø 6,5 cm 82310, 82312, 82314, 82307, 82308, 82309, 82370, 82371 |

2 ltr.



Glas, luftdichter Deckelverschluss
glas, airtight closing
crystal, cierre hermético
verre, fermeture hermétique



| | cm | cm | ltr. |
|---------|---------|----|------|
| 82328 0 | 12 x 12 | 22 | 2 |



Weck-Gläser
82310, 82312 und 82314

Naturschieferplatte
natural slate tray
bandeja pizarra natural
plat ardoise naturelle

mit 3 Absätzen, Ø 5,5 cm
with 3 holes, Ø 5,5 cm
con 3 agujeros, Ø 5,5 cm
avec 3 trous diam. 5,5 cm



| | | |
|---------|---------|-------|
| | cm | mm |
| 00987 5 | 28 x 10 | 4 - 7 |



Naturschieferplatte
natural slate tray
bandeja pizarra natural
plat ardoise naturelle

mit Absatz Ø 5,5 cm
with hole Ø 5,5 cm
con agujero, Ø 5,5 cm
avec trou diam. 5,5 cm



| | | |
|---------|---------|-------|
| | cm | mm |
| 00986 8 | 25 x 12 | 4 - 7 |



Weck-Glas
220 ml - 82316

2 Absätze Ø 6 cm

Naturschieferplatte / Untersetzer
natural slate tray
bandeja pizarra natural
plat ardoise naturelle

mit 2 Absätzen Ø 6 cm
with 2 holes Ø 6 cm
con 2 agujeros Ø 6 cm
avec 2 trous Ø 6 cm



| | | |
|---------|--------|-------|
| | cm | mm |
| 00971 4 | 15 x 8 | 4 - 7 |

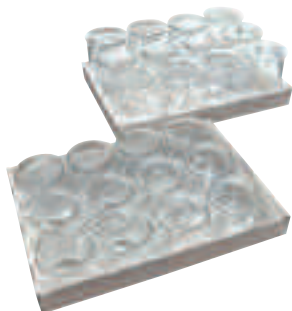

Gourmet-Gläser, 12er Set
gourmet glasses, 12 pcs.
pack de 12 tarros Gourmet
pack de 12 verres Gourmet



| | cm | cm | ltr. | pcs. |
|---------|-----|-----|------|------|
| 82370 9 | Ø 6 | 5,5 | 0,08 | 12 |
| 82371 6 | Ø 6 | 8 | 0,16 | 12 |

passen in Gestell 33246 + 33247



Zubehör / spare parts / recambios / pièces de rechange

10er Set Gummidichtringe, für Deckel der Weck-Gläser, im Beutel verpackt
10 pcs. rubber washer for covers of Weck-glasses
10 juntas de goma para las tapas de los tarritos Weck
jeu de 10 joints caoutchouc pour la fermeture des verrines

| | |
|---------|------------------------|
| 82318 1 | for all glasses Ø 6 cm |
| 82394 5 | matches 82345 |
| 82395 2 | matches 82346, 82347 |

8er Set Deckel-Klammer für 4 Weck-Gläser, im Beutel verpackt
8 pcs. cover clamps for 4 Weck-glasses
8 abrazaderas para 4 vasitos Weck
8 agrafes pour 4 verrines Weck

| |
|---------|
| 82319 8 |
|---------|



11220
GN1/1

Tablett „SUNDAY“
tray with wide inclined rim
bandeja bordes anchos
plateau à larges bords



hochglanzpoliert
 mirror polished finish
 acabado espejo pulido
 effet brillant



11210
GN1/2



11211

| | ▣ cm | ↑ cm | GN |
|---------|-------------|------|-----|
| 11220 9 | 53 x 32,5 | 2 | 1/1 |
| 11210 0 | 32,5 x 26,5 | 2 | 1/2 |
| 11211 7 | Ø 46 | 2 | - |

Tablett „SUNDAY“
tray
bandeja
plateau



hochglanzpoliert, Griffe inkl. Fixierung, kein Verrutschen möglich, Nutzhöhe 4 cm
 mirror polished finish, with handles for extra secure stacking, distance 4 cm
 pulido espejo, con 2 asas para apilado muy estable, distancia 4 cm entre bandejas
 effet brillant, 2 anses pour empilement très stable, distance 4 cm entre plateaux



11222
GN1/1

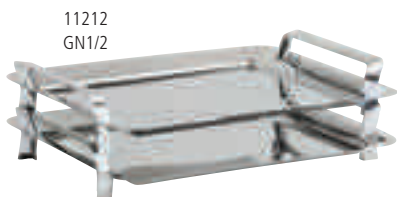

11212
GN1/2

| | ▣ cm | ↑ cm | GN |
|---------|-------------|------|-----|
| 11222 3 | 53 x 32,5 | 6 | 1/1 |
| 11212 4 | 32,5 x 26,5 | 6 | 1/2 |



Buffet-Tablett
buffet-tray
bandeja de buffet
plateau buffet

11470



rund

Die mehrstufigen Buffet-Tabletts sind tolle Blickfänge auf jedem Buffet. Sind einfach zu dekorieren und werden zum echten Hingucker.

perfect for the buffet and party service
 perfecta para el servicio de bufet y fiesta
 idéal pour buffets et catering

| | □ cm | ↑ cm | GN |
|---------|-----------|------|-----|
| 11470 8 | Ø 48 | 4,5 | - |
| 11475 3 | 53 x 32,5 | 3,5 | 1/1 |

11475

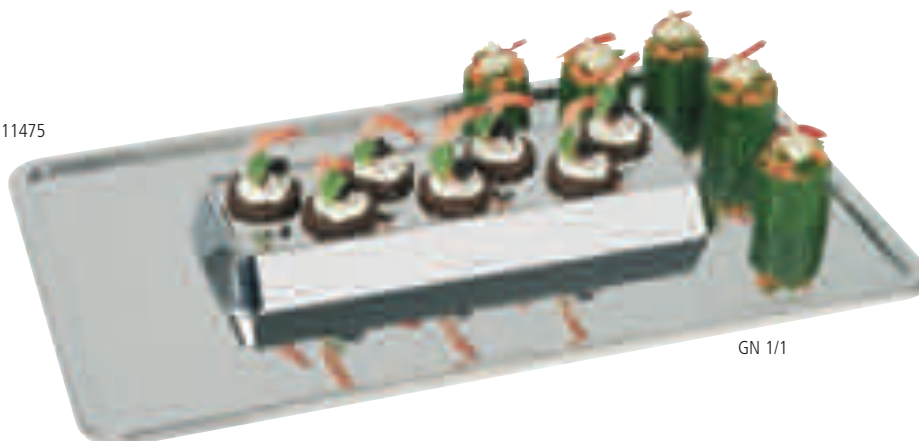

GN 1/1



Tablett „BRAZIL“
tray
bandeja de buffet
plateau buffet



rund

Rand hochglanzpoliert, Rand eingerollt, schwere Ausführung
 mirror polished finish edge, rolled edge, high quality
 borde pulido efecto espejo, borde redondeado, alta calidad
 contour poli miroir, bord rond, haute qualité

| | □ cm |
|---------|------|
| 01437 4 | Ø 45 |



Tablett „TOP LINE“
tray
bandeja
plat

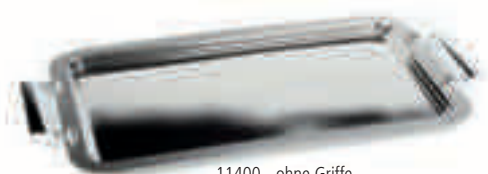

11400 - ohne Griffe
 11410 - mit verchromten Griffen

Rand matt poliert, innen hochglanzpoliert
 inside mirror polished finish
 interior pulido efecto espejo
 contour poli effet mat, intérieur poli miroir

| | □ cm | GN | |
|---------|-------------|-----|--|
| 11400 5 | 53 x 32,5 | 1/1 | ohne Griffe / without handles sin asa / sans poignées |
| 11410 4 | 61,5 x 32,5 | - | mit verchromten Griffen with chrome plated handles con asas cromadas avec poignées chromées |



Tablett „SWING“
tray
bandeja
plat



Rand matt poliert, innen hochglanzpoliert
satin polished finish edge, inside mirror polished finish
borde pulido efecto satinado, interior pulido efecto espejo
contour effet mat, intérieur poli miroir

| | ▣ cm | ↑ cm |
|---------|-------------|------|
| 01416 9 | 32,5 x 32,5 | 1 |

01415



Tablett „SWING“
tray
bandeja
plat



Rand matt poliert, innen hochglanzpoliert
satin polished finish edge, inside mirror polished finish
borde pulido efecto satinado, interior pulido efecto espejo
contour effet mat, intérieur poli miroir

| | ▣ cm | ↑ cm | GN |
|---------|-----------|------|-----|
| 01415 2 | 28,5 x 20 | 1 | - |
| 01420 6 | 53 x 32,5 | 1 | 1/1 |

GN 1/1
01420



Tablett „SWING“
tray
bandeja
plateau empilable



Rand matt poliert, innen hochglanzpoliert, Nutzhöhe 4 cm, massive Griffe verchromt, inkl. fest verschraubten Distanzstücken
satin polished finish edge, stackable 4 cm, chrome handles
borde pulido efecto satinado, apilable 4cm., asas cromadas.
contour effet mat, empilable distance 4 cm, poignées chromées

| | ▣ cm | GN |
|---------|-----------|-----|
| 01425 1 | 53 x 32,5 | 1/1 |

GN 1/1

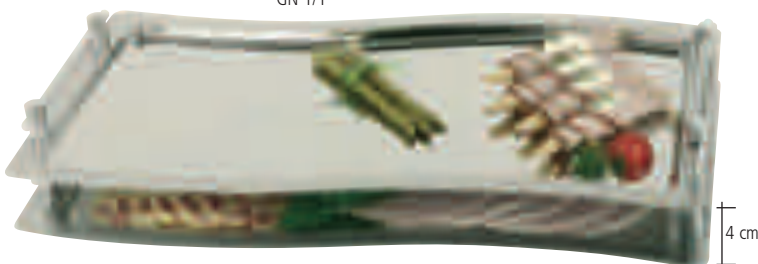



11150 - mit verchromten Griffen
11155 - mit vergoldeten Griffen



11160 - mit verchromten Griffen
11165 - mit vergoldeten Griffen

**System-Tablett „BUFFET-STAR“
tray
bandeja
plat empilable système catering**



Rand hochglanzpoliert, inkl. fest verschraubten Griffen inkl. Distanzstücken, Nutzhöhe 4 cm
mirror polished finish edge, incl. screwed handles incl. distance pillars, 4 cm distance
borde pulido efecto espejo, incluye asas atornillables, distanciadores a 4cm
contour effet miroir, poignées à visser, distance approx. 4 cm

| | cm | GN | |
|---------|-----------|-----|--|
| 11150 9 | 53 x 32,5 | 1/1 | mit verchromten Griffen with chrome plated handles con asas cromadas avec poignées chromées |
| 11155 4 | 53 x 32,5 | 1/1 | mit vergoldeten Griffen with gold plated handles con asas doradas avec poignées dorées |
| 11160 8 | Ø 48 | | mit verchromten Griffen with chrome plated handles con asas cromadas avec poignées chromées |
| 11165 3 | Ø 48 | | mit vergoldeten Griffen with gold plated handles con asas doradas avec poignées dorées |



ideal für das
platzsparende
Servieren, Lagern
und Transportieren



**System-Tablett „CLASSIC“
tray
bandeja
plat empilable système catering**



Rand hochglanzpoliert, mit fest verschraubten Griffen inkl. Distanzstücken, Nutzhöhe 3,5 cm
mirror polished finish edge, incl. screwed handles incl. distance pillars, 3,5 cm distance
borde pulido efecto espejo, incluye asas atornillables, distanciadores a 3,5cm
contour effet miroir, poignées à visser, distance approx. 3,5 cm

| | cm | GN |
|---------|-----------|-----|
| 11295 7 | 53 x 32,5 | 1/1 |

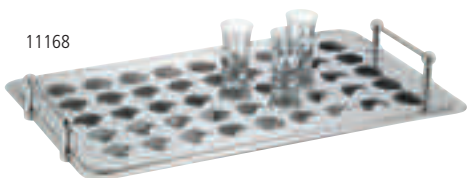

**System-Tablett Set „BUFFET-STAR“
tray set
set bandejas
ensemble plateau GN 1/1 + plaque 45 trous**



2-teilig: Tablett mit Griffen zum Stapeln + 1 Lochtablett mit 45 Löchern Ø 3,7 cm (Nr. 11170)
2 pcs. set: 1 tray with handles, stackable + 1 hole plate with 45 holes Ø 3,7 cm (No. 11170)
2 piezas: 1 bandeja con asas, apilable + 1 placa con 45 agujeros Ø 3,7 cm (No. 11170)
2 pièces: plateau 2 anses empilable + plaque 45 trous Ø 3,7 cm (No. 11170)

| | cm | GN |
|---------|-----------|-----|
| 11168 4 | 53 x 32,5 | 1/1 |

Einzelteile / spare parts / piezas sueltas / pièces détachées

Lochtablett mit 45 Löchern Ø 3,7 cm / hole plate with 45 holes Ø 3,7 cm
placa con agujeros / plaque 45 trous Ø 3,7 cm

| | | |
|---------|-------------|--|
| 11170 7 | 50,5 x 29,5 | |
|---------|-------------|--|

PROFI LINE



Edelstahl-Tablett „PROFI LINE“
tray
bandeja
plat empilable système catering



hochglanzpoliert
 mirror polished finish
 borde pulido efecto espejo
 effet miroir



mit glattem Rand
 11100, 12100



mit Dekor-Rand
 11000, 12000



11110

| | cm | cm | GN | |
|---------|-------------|-----|-----|---|
| 11100 4 | 53 x 32,5 | 1,5 | 1/1 | mit glattem Rand / without decor-edge sin borde decorado / bords lisses |
| 12100 3 | 32,5 x 26,5 | 1,5 | 1/2 | mit glattem Rand / without decor-edge sin borde decorado / bords lisses |
| 11000 7 | 53 x 32,5 | 1,5 | 1/1 | mit Dekor-Rand / with decor-edge con borde decorado / bords avec relief |
| 12000 6 | 32,5 x 26,5 | 1,5 | 1/2 | mit Dekor-Rand / with decor-edge con borde decorado / bords avec relief |
| 11110 3 | 53 x 32,5 | 1,0 | 1/1 | glatter schmaler Rand / smooth narrow edge borde estrecho liso / bord étroit lisse |



11252
Distanzstücke können per Hand
aufgeschraubt werden.
Distance pieces can be bolted by hand.

System-Tablett „PROFI LINE“
tray
bandeja
plat empilable système catering



Rand hochglanzpoliert, massive Bügelgriffe vergoldet, inkl. fest verschraubten Distanzstücken, Nutzhöhe 4 cm

mirror polished finish edge, gold plated handles, stackable approx. 4 cm

borde con acabado pulido, asas doradas, apilables aproximadamente 4 cm

contour effet miroir, poignées dorées, empilables distance 4 cm environ

| | cm | GN |
|---------|-----------|-----|
| 11290 2 | 53 x 32,5 | 1/1 |

Einzelteile / spare parts / piezas sueltas / pièces détachées

8 cm Distanzstück-Set (4 Stück), vergoldet / 8 cm distance pillars (4 pcs.), gold plated distanciadores a 8 cm (4 piezas) dorado / Kit réhausseur (4 pièces) distance totale 8 cm

11252 0

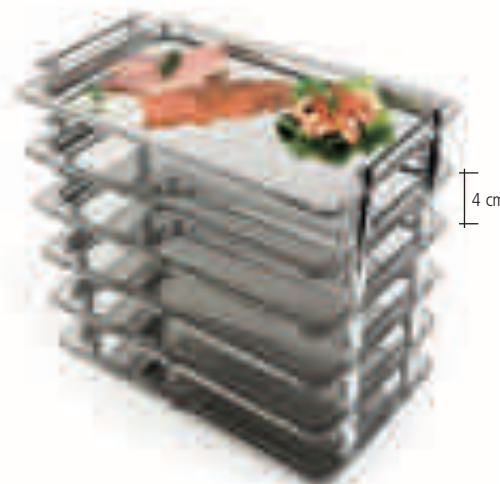

11310
Distanzstücke können per Hand
aufgeschraubt werden.
Distance pieces can be bolted by hand.

System-Tablett „PROFI LINE“
tray
bandeja
plat empilable système catering



Dekorrand hochglanzpoliert, massive Griffe verchromt, inkl. fest verschraubten Distanzstücken, Nutzhöhe 4 cm

decor edge mirror polished finish, chrome plated handles, incl. mounted 4 cm distance pillars

borde pulido decorado, asas cromadas, incluye distanciadores a 4 cm

bords polis avec reliefs, poignées chromées, distance approx. 4 cm

| | cm | GN |
|---------|-----------|-----|
| 11300 8 | 53 x 32,5 | 1/1 |

Einzelteile / spare parts / piezas sueltas / pièces détachées

Distanzstück-Set / distance piece set / set de distanciadores / Kit réhausseur

11310 7



GN1/1
und
GN1/2

Edelstahl-Tablett „PROFI LINE“
pan
cubeta
bac GN



Dekorrand hochglanzpoliert, mit Stapelnocke

decor edge mirror polished finish

cubeta de acero inoxidable

bac GN, bord brillant avec relief, désempilage facile

| | cm | cm | GN | ltr. |
|---------|-------------|-----|-----|------|
| 11020 5 | 53 x 32,5 | 2,0 | 1/1 | 1,7 |
| 11040 3 | 53 x 32,5 | 4,0 | 1/1 | 3,4 |
| 11065 6 | 53 x 32,5 | 6,5 | 1/1 | 7,0 |
| 12040 2 | 32,5 x 26,5 | 4,0 | 1/2 | 2,0 |
| 12065 5 | 32,5 x 26,5 | 6,5 | 1/2 | 3,3 |

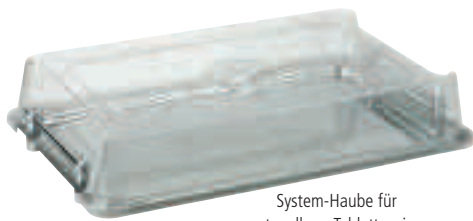

System-Haube für stapelbare Tablett wie Nr. 11300, 11290 oder 11295

Haube GN 1/1 „HOCHSTAPLER“
cover GN 1/1 high stacker
campana GN 1/1 especial para apilar
cloche GN 1/1 spéciale empilage



glasklarer Kunststoff, passend zum Tablett 11300, 11290, 11295, Tablett fixiert sich auf der Haube - kein Rutschen möglich, nahezu bruchfest

clear plastic, for tray 11300, 11290, 11295, tray fixes itself on the cover and can not slip off, nearly unbreakable

plástico transparente para bandejas 11300, 11290, 11295, la bandeja se fija a la tapa para que no se deslice, muy resistente a la rotura

en plastique transparent pour plats 11300, 11290, 11295. Le plat se fixe sur le dessous de la cloche pour ne pas glisser, très résistant à la casse

| | cm | cm | GN |
|---------|-----------|----|-----|
| 11305 3 | 53 x 32,5 | 9 | 1/1 |

GN 1/1, 2-tlg. Set
Tablett + Haube



System-Haube für stapelbare Tablett wie Nr. 11300, 11290 oder 11295

Buffet-Set „HOCHSTAPLER“
buffet set
set de bufet
Kit catering plateau + cloche



2-teilig: Tablett 11300 + Haube 11305, Tablett fixiert sich auf der Haube - kein Rutschen möglich

2 pcs. set: tray 11300 + cover 11305, tray fixes itself on the cover and can not slip off

2 piezas: bandeja 11300+ tapa 11305 la bandeja se fija a la tapa para que no se deslice

2 pièces: plateau réf. 11300 + cloche spéciale empilement stable

| | cm | cm | GN |
|---------|-----------|------|-----|
| 11302 2 | 53 x 32,5 | 10,5 | 1/1 |

11195
2-tlg. Set Tablett + Haube



stapel- und fixierbar

Buffet-Set „CATERER“
buffet set
set bufet
set catering: plateau + cloche



2-teilig: Tablett 11100 + Haube 11003, Tablett fixiert sich auf der Haube - kein Rutschen möglich

2 pcs. set: tray 11100 + cover 11003, tray fixes itself on the cover and can not slip off

set de 2 piezas: bandeja 11100 + tapa 11003, la bandeja encaja encima de la tapa para que no se deslice.

ensemble de 2 pièces. Plateau GN 1/1 réf. 11100 + cloche 11003 spéciale empilement stable

| | cm | cm | GN |
|---------|-----------|------|-----|
| 11195 0 | 53 x 32,5 | 10,5 | 1/1 |

Abdeckhaube GN
cover GN
cubierta GN
cloche GN



| | | | |
|---------|-------------|-----|-----|
| 11001 4 | 32,5 x 26,5 | 9,5 | 1/2 |
| 11003 8 | 53 x 32,5 | 9,5 | 1/1 |



11003
GN 1/1

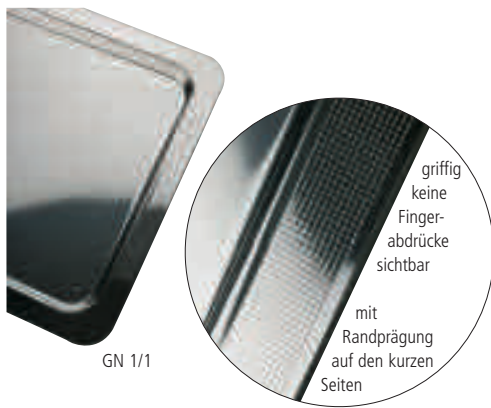

Tablett „STAR“
tray
bandeja
plat



Rand hochglanzpoliert mit Prägung
polished decor edge
borde pulido decorado.
bords polis miroir, avec relief sur les petits côtés

| | cm | GN |
|---------|-----------|-----|
| 11115 8 | 53 x 32,5 | 1/1 |



Buffet-Tablett „HALBMOND“
tray
bandeja
plat demi-lune



mit klassischem Linienprägedekor, passend für Thermoboxen GN1/1 und Thermoporte
with decor edge, usable in thermoboxes GN1/1
con borde decorado, apto para cajas térmicas GN 1/1
bords avec relief, apte pour conteneurs GN 1/1

| | cm | GN |
|---------|-----------|-----|
| 11111 0 | 53 x 32,5 | 1/1 |

Fleisch- und Gemüseplatte „PROFI LINE“
tray
fuente de servicio
plat de service



Dekorrand hochglanzpoliert
decor edge mirror polished finish
borde decorado pulido efecto espejo
contour relief avec effet miroir

| | cm | ↑ cm | |
|---------|---------|------|-------------------------------|
| 11032 8 | Ø 32 | 2,6 | rund / round / redondo / rond |
| 11038 0 | Ø 38 | 2,6 | rund / round / redondo / rond |
| 11048 9 | Ø 48 | 2,6 | rund / round / redondo / rond |
| 11023 6 | 50 x 36 | 2,6 | oval / oval / ovalado / ovale |
| 11024 3 | 60 x 41 | 2,6 | oval / oval / ovalado / ovale |
| 11025 0 | 70 x 46 | 2,6 | oval / oval / ovalado / ovale |

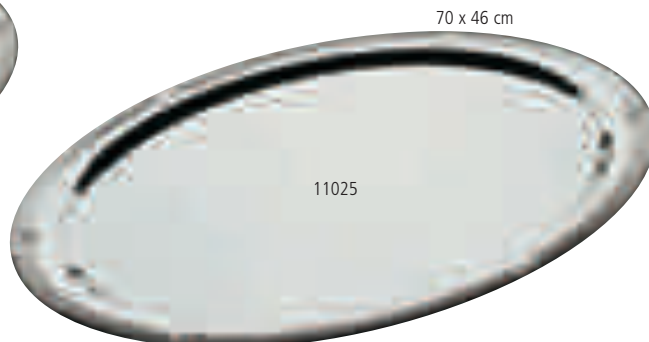
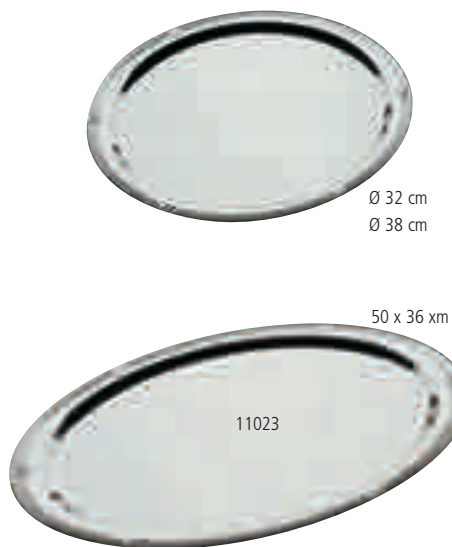

designed by **CULTURE FORM**



Buffet-Brett „FISCH“
board
tabla para el buffet
planche à découper buffet



Buchenholz, mit Antirutsch-Füßchen
beech wood, with non-slip feet
haya, pies antideslizantes
hêtre, pieds anti-dérapants

| | cm | ↑ cm |
|---------|---------|------|
| 00860 1 | 76 x 23 | 2,5 |

designed by **CULTURE FORM**



Buffet-Brett „RIND“
board
tabla para el buffet
planche à découper buffet



Buchenholz, mit Antirutsch-Füßchen
beech wood, with non-slip feet
haya, pies antideslizantes
hêtre, pieds anti-dérapants

| | cm | ↑ cm |
|---------|---------|------|
| 00861 8 | 62 x 34 | 2,5 |

designed by **CULTURE FORM**



Buffet-Brett „SCHWEIN“
board
tabla para el buffet
planche à découper buffet



Buchenholz, mit Antirutsch-Füßchen
beech wood, with anti-slip feet
haya, pies antideslizantes
hêtre, pieds anti-dérapants

| | cm | ↑ cm |
|---------|---------|------|
| 00862 5 | 66 x 30 | 2,5 |

designed by **CULTURE FORM**



18388

Buffet-Brett „TRAUBE“
board
tabla para el buffet
planche à découper buffet



Buchenholz, Antirutsch-Füßchen
beech wood, non-slip feet
haya, pies antideslizantes
hêtre, pieds anti-dérapants

| | cm | ↑ cm |
|---------|-----------|------|
| 00863 2 | 43,5 X 38 | 2,5 |

Rolltophaube / rolltop cover / campana abatible / cloche basculante

| | | |
|---------|------|----|
| 18388 9 | Ø 38 | 20 |
|---------|------|----|



Tablett „PRO“
tray
bandeja
plateau



hochglanzpoliert, Rand eingerollt, stabile Ausführung
mirror polished finish, rolled edge, heavy quality
acabado pulido efecto espejo, borde redondeado, alta calidad
effet miroir, bord rond, qualité extra

| | cm | GN |
|---------|-----------|-----|
| 01300 1 | 42 x 32 | - |
| 01305 6 | 48 x 37 | - |
| 01306 3 | 53 x 32,5 | 1/1 |

Tablett „FINESSE“
tray
bandeja
plat



glatter Rand
plane seam / edge
borde plano
bord plat



oval

| | cm | ↑ cm |
|---------|---------|------|
| 01322 3 | 42 x 30 | 2,5 |
| 01323 0 | 50 x 36 | 2,5 |
| 01324 7 | 60 x 41 | 2,5 |
| 01325 4 | 70 x 46 | 2,5 |

Tablett „FINESSE“
tray
bandeja
plat



glatter Rand
plane seam / edge
borde plano
bord plat



rechteckig



rund

| | cm | |
|---------|---------|--|
| 01314 8 | 30 x 24 | rechteckig / rectangular / rectangular / rectangulaire |
| 01313 1 | 35 x 24 | rechteckig / rectangular / rectangular / rectangulaire |
| 01317 9 | 39 x 26 | rechteckig / rectangular / rectangular / rectangulaire |
| 01312 4 | 42 x 31 | rechteckig / rectangular / rectangular / rectangulaire |
| 01318 6 | 48 x 30 | rechteckig / rectangular / rectangular / rectangulaire |
| 01311 7 | 50 x 38 | rechteckig / rectangular / rectangular / rectangulaire |
| 01310 0 | 58 x 42 | rechteckig / rectangular / rectangular / rectangulaire |
| 01309 4 | 68 x 48 | rechteckig / rectangular / rectangular / rectangulaire |
| 01332 2 | Ø 32 | rund / round / redondo / rond |
| 01335 3 | Ø 35 | rund / round / redondo / rond |
| 01338 4 | Ø 38 | rund / round / redondo / rond |
| 01348 3 | Ø 48 | rund / round / redondo / rond |
| 01349 0 | Ø 49,5 | rund / round / redondo / rond |
| 01358 2 | Ø 58 | rund / round / redondo / rond |

**HOT
PRICE**

00393



**Partyplatte
partytray
bandeja Party
plateau Party**



Innenfläche ziseliert, Rand eingerollt, einzeln mit verkaufsförderndem Farbeinleger
rolled edge, decorated surface
borde redondeado, superficie totalmente decorada
bord rond, surface entièrement ciselee

| | cm | VE | |
|---------|---------|----|---|
| 00393 4 | Ø 35 | 48 | rund / round / redondo / rond |
| 00391 0 | 46 x 34 | 48 | oval / oval / ovalada / ovale |
| 00392 7 | 41 x 31 | 48 | rechteckig / rectangular rectangular / rectangulaire |

00391



nicht säure- und spülmaschinenfest, Lebensmittel nur mit
Papierdeckchenunterlage servieren

metal nickel plated and chrome plated, not resistant to
food, acidity, oils, sauces, not suitable for dishwasher

00392



**HOT
PRICE**

GN 1/1

**Partyplatte GN1/1
partytray
bandeja de fiesta
plateau Party**



Innenfläche ziseliert, Rand eingerollt, mit verkaufsförderndem Farbeinleger
rolled edge, decorated surface
borde redondeado, superficie totalmente decorada

| | cm | VE | GN |
|---------|-----------|----|-----|
| 00394 1 | 53 x 32,5 | 36 | 1/1 |



nicht säure- und spülmaschinenfest, Lebensmittel nur mit
Papierdeckchenunterlage servieren

metal nickel plated and chrome plated, not resistant to
food, acidity, oils, sauces, not suitable for dishwasher

**HOT
PRICE**

2 Größen:
GN1/1 - 53 x 32,5 cm
41 x 31 cm

Partyplatte „CLASSIC“
partytray
bandeja Party
plateau party



mit Liniendekor, Rand eingerollt, patentiertes Design, einzeln im Beutel, mit Farbeinleger
with line decor, rolled edge, „Patent Design“, with colour inlay
con filos en relieve, diseño patentado, presentación con foto color
avec décoration lignée, bord rond, présentation avec photo couleur



| | cm | VE | GN | |
|---------|-------------|----|-----|---|
| 00395 8 | 53 x 32,5 | 36 | 1/1 | rechteckig / rectangular rectangular / rectangulaire |
| 00399 6 | 41 x 31 | 48 | - | rechteckig / rectangular rectangular / rectangulaire |
| 00389 7 | 35,2 x 32,5 | 48 | - | rechteckig / rectangular rectangular / rectangulaire |
| 00396 5 | Ø 35 | 48 | - | rund / round redondo / rond |
| 00398 9 | 46 x 34 | 48 | - | oval / oval oval / ovale |

nicht säure- und spülmaschinenfest, Lebensmittel nur mit
Papierdeckchenunterlage servieren

metal nickel plated and chrome plated, not resistant to
food, acidity, oils, sauces, not suitable for dishwasher

Servierartikel
serving items



No. 00393 - 96 x
oder / or / o / ou
No. 00396 - 96 x

No. 00391 - 96 x
oder / or / o / ou
No. 00398 - 96 x

No. 00392 - 96 x
oder / or / o / ou
No. 00399 - 96 x

No. 00394 - 72 x
oder / or / o / ou
No. 00395 - 72 x

Warenträger
display
expositor
présentoir

für Partyplatten

- platzsparende flexible Präsentation durch geringe Abmessungen
- als Zweitplatzierung für Ihre zusätzlichen Umsätze
- in weiß lieferbar

for partytrays- space saving presentation- small size- available in white

para bandejas Party, ocupa poco espacio, con ruedas, disponible en blanco

pour plateaux Party, occupe très peu d'espace, sur roues, disponible en blanc

| | cm | ↑ cm |
|---------|---------|------|
| 00397 2 | 55 x 65 | 190 |



Tablett „SCHÖNER ESSEN“
tray
bandeja
plateau



mit Dekorrand, Griffe Zinkdruckguss verchromt, genietet
 with decor edge, handles zinc alloy chrome plated, riveted
 borde decorado, asas fundición con zinc,
 bord décor, poignées en fonte zinguée

| | cm |
|---------|-----------|
| 00082 7 | 52 x 31 |
| 00081 0 | 60 x 36 |
| 00084 1 | 75 x 44,5 |



Tablett „SCHÖNER ESSEN“
tray
bandeja
plateau



mit Dekorrand
 with decor edge
 con borde decorado
 bord décor

| | cm | GN |
|---------|-------------|---|
| 00383 5 | 35 x 24 | - |
| 00382 8 | 42 x 31 | - |
| 00381 1 | 50 x 36 | - |
| 00384 2 | 63,5 x 44,5 | - |
| 00385 9 | 60 x 40 | - |
| 00388 0 | 53,0 x 32,5 | 1/1 |
| 03824 0 | 42 x 31 | leichte Ausführung 0,5 mm / extra light model 0,5 mm |
| 03814 1 | 50 x 36 | leichte Ausführung 0,5 mm / extra light model 0,5 mm |
| 00087 2 | 38 x 23 | rechteckig, abgerundet / rectangular, rounded edge rectangular / rectangulaire |
| 00086 5 | 47 x 31 | rechteckig, abgerundet / rectangular, rounded edge rectangular / rectangulaire |
| 00089 6 | 50 x 39,5 | oval |



rechteckig,
 abgerundet
 00086
 00087



oval
 00089



Tablett „SCHÖNER ESSEN“
tray
bandeja
plateau



| | cm |
|---------|------|
| 00075 9 | Ø 31 |
| 00085 8 | Ø 35 |



verchromte
 Messing-Griffe

Tablett „FINESSE“
 tray
 bandeja
 plateau

verchromte Messing-Griffe
 chrome plated brass handles
 asas de latón cromadas
 poignées en laiton chromées



| | cm |
|---------|---------|
| 01712 2 | 44 x 31 |
| 01711 5 | 52 x 38 |
| 01710 8 | 60 x 42 |
| 01709 2 | 70 x 48 |



rund und oval
 mit verchromten oder
 vergoldeten Griffen

Tablett „FINESSE“
 tray
 bandeja
 plateau

verchromte Messing-Griffe
 chrome plated brass handles
 asas plateadas de latón
 poignées en laiton chromées



| | cm | litr. | |
|---------|-----------------|-------|-------------------------------|
| 01723 8 | 51 x 36 x 2,6 | 2,0 | oval / oval / ovalada / ovale |
| 01725 2 | 71,5 x 46 x 2,6 | 4,0 | oval / oval / ovalada / ovale |
| 01738 2 | Ø 38 x 2,6 | | rund / round / redondo / rond |
| 01748 1 | Ø 48 x 2,6 | | rund / round / redondo / rond |



Tablett „ELEGANCE“
 tray
 bandeja
 plateau

| | cm |
|---------|---------|
| 02310 9 | 41 x 26 |
| 02311 6 | 48 x 30 |
| 02312 3 | 60 x 37 |



18641
 Haube

23642
 Königsuchenplatte

Tablett mit Haube „ELEGANCE“
 tray with cover
 bandeja con cubierta
 plateau avec cloche

| | cm |
|---------|---------|
| 23642 4 | 35 x 19 |





Tablett mit Haube „FINESSE“
tray with cover
bandeja con campana
plateau avec cloche



| | cm | |
|---------|---------|---|
| 13122 4 | 42 x 31 | ohne Griffe without handles sin asas sans poignées |



Tablett mit Haube „FINESSE“
tray with cover
bandeja con campana
plateau avec cloche



| | cm | |
|---------|------------|---|
| 13622 9 | Ø 22 x 9,5 | ohne Griffe without handles sin asas sans poignées |



Haubenhöhe
11,5 cm oder
12,5 cm

13382

Tablett mit Haube „FINESSE“
tray with cover
bandeja con cubierta
plateau avec cloche



| | cm | ↑ cm |
|---------|------|------|
| 13382 2 | Ø 38 | 12 |
| 13385 3 | Ø 38 | 13 |

Einzelteile / spare parts / piezas sueltas / pièces détachées

Frischhalte-Haube / cover / campana / cloche (13382)

| | | |
|---------|------|------|
| 06510 9 | Ø 30 | 11,5 |
|---------|------|------|

Frischhalte-Haube / cover / campana / cloche (13385)

| | | |
|---------|------|------|
| 06515 4 | Ø 33 | 12,5 |
|---------|------|------|

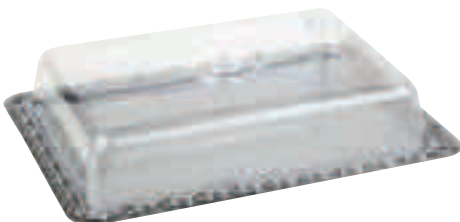

Tablett mit Haube „SCHÖNER ESSEN“
tray with cover
bandeja con cubierta
plateau avec cloche



| | cm | |
|---------|---------|--|
| 38202 2 | 42 x 31 | |

Frischhalte-Haube / cover / campana / cloche (13385)

| | | |
|---------|------|------|
| 06515 4 | Ø 33 | 12,5 |
|---------|------|------|



Servierpfanne
pan
fuenta 2 asas para la mesa
plat à 2 anses pour la table



mit vergoldeten Edelstahl-Griffen, 1 mm dick
 with gold plated handles, 1 mm thickness
 grosor 1 mm., asas doradas
 épaisseur 1 mm, poignées dorées

| | □ cm | ↑ cm | ltr. |
|---------|------|------|------|
| 61400 0 | Ø 40 | 5 | 4,5 |



Servier- / Beilagenschale
serving dish
fuenta de servir
plat de service



mit vergoldeten Edelstahl-Griffen
 with gold plated handles
 con asas inox doradas
 poignées inox dorées

| | □ cm | ↑ cm | ltr. |
|---------|------|------|------|
| 61150 4 | Ø 15 | 3,5 | 0,4 |
| 61190 0 | Ø 19 | 3,5 | 0,7 |
| 61280 8 | Ø 28 | 4 | 2 |



Servier- / Beilagenschale
serving dish
fuenta de servir
plat de service



mit vergoldeten Edelstahl-Griffen
 with gold plated handles
 con asas inox doradas
 poignées inox dorées

| | □ cm | ↑ cm | ltr. |
|---------|-------------|------|------|
| 60270 0 | 26,5 x 19,5 | 3 | 0,8 |
| 60310 3 | 31 x 21,5 | 3 | 1,2 |
| 60380 6 | 37 x 26,5 | 3 | 1,7 |



Servier- / Beilagenschale
serving dish
fuenta de servir
plat de service



mit Edelstahl-Griffen
 with stainless steel handles
 con asas de acero inoxidable
 poignées inox

| | □ cm | ↑ cm | ltr. |
|---------|------|------|------|
| 61155 9 | Ø 15 | 3,5 | 0,4 |
| 61195 5 | Ø 19 | 3,5 | 0,7 |
| 61285 3 | Ø 28 | 4 | 2,0 |



Servier- / Beilagenschale
servicing dish
fuelle de servir
plat de service



mit
Edelstahl-Griffen

mit Edelstahl-Griffen
 with stainless steel handles
 asas de acero inoxidable
 poignées inox

| | cm | cm | ltr. |
|---------|-------------|----|------|
| 60275 5 | 26,5 x 19,5 | 3 | 0,8 |
| 60315 8 | 31 x 21,5 | 3 | 1,2 |
| 60385 1 | 37 x 26,5 | 3 | 1,7 |



Fischplatte
fish platter
fuelle pez
plat poisson



| | cm | cm |
|---------|-------------|-----|
| 01329 2 | 57,5 x 19,5 | 3,5 |



Fischplatte
fish platter
fuelle pez
plat poisson



hochglanzpoliert
 mirror polished finish
 acabado efecto espejo
 finition poili miroir

| | cm | cm |
|---------|-----------|----|
| 01328 5 | 66 x 22,5 | 2 |



Fischplatte „BIG“
fish plate
cuenco para pescado
plat creux à poisson



| | cm | cm |
|---------|-------------|-----|
| 83996 0 | 58,5 x 28,0 | 5,5 |

designed by **CULTURE FORM**



Buffet-Brett „FISCH“
board
tabla para el buffet
planche à découper buffet



Buchenholz, mit Antirutsch-Füßchen
 beech wood, with non-slip feet
 haya, pies antideslizantes
 hêtre, pieds anti-dérapants

| | cm | cm |
|---------|---------|-----|
| 00860 1 | 76 x 23 | 2,5 |



Bratenplatte „HIGH LINE“
meat platter
fuelle servicio
plat de service



hochglanzpoliert

hochglanzpoliert, Rand eingerollt
 mirror polished finish, rolled edge
 acabado pulido efecto espejo, borde redondeado
 poli miroir, bord rond

| | cm |
|---------|-------------|
| 30004 0 | 31 x 22 |
| 30005 7 | 41,5 x 30 |
| 30006 4 | 46,5 x 33,5 |

Bratenplatte „ECO LINE“
meat platter
fuelle servicio
plat de service



poliert, Rand eingerollt
 polished, rolled edge
 pulido, borde redondeado
 poli miroir, bord rond

| | cm |
|---------|---------|
| 30100 9 | 25 x 18 |
| 30101 6 | 30 x 22 |
| 30102 3 | 35 x 22 |
| 30103 0 | 40 x 26 |
| 30104 7 | 45 x 30 |
| 30105 4 | 50 x 35 |



Tablett
tray
bandeja
plateau



mit gebördeltem polierten Rand
 rolled mirror polished finish edge
 borde redondeado acabado efecto espejo
 bord rond, effet miroir

| | cm | ↑ cm |
|---------|------|------|
| 01336 0 | Ø 35 | 3 |

Buffetständer
seafood stand
soporte para marisco
pied à fruits de mer



für Tablett 01336
 for tray 01336
 para bandeja 01336
 pour plateau 01336

| | | |
|---------|-----------|----|
| 74207 9 | Ø 20 - 25 | 19 |
|---------|-----------|----|



74207



01336



Servier- / Tortenplatte
cake stand
sporte para pastel
présentoir à gâteaux



00466

passende Abdeckhaube
06517

hochglanzpoliert, mit hohem Fuß (fest verbunden)
 mirror polished finish, with tall foot
 acabado brillante, con pie alto
 poli brillant, pied haut

| | cm | cm |
|---------|--------|------|
| 00466 5 | Ø 34,5 | 13,5 |

Einzelteile / spare parts / piezas sueltas / pièces détachées

Frischhalte-Haube / cover / campana / cloche

| | | |
|---------|------|------|
| 06517 8 | Ø 33 | 12,5 |
|---------|------|------|

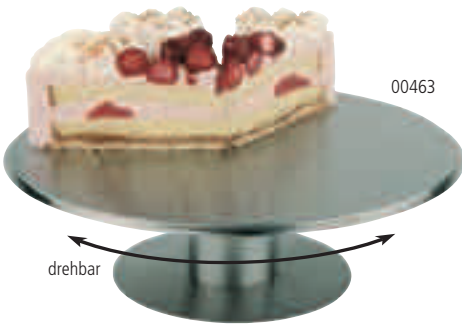

00463

drehbar

Servierplatte / Tortenplatte „INOX“
plate / cake plate
porta tartas
guéridon à gâteau



matt poliert, drehbar, möbelschonende Moosgummi-Unterseite
 satin polished finish, rotating, foam rubber below to save your furniture
 acabado pulido satinado, giratorio, base revestida de goma para no rallar el mobiliario
 poli satiné, plateau tournant, revêtement mousse sous le pied pour ne pas rayer les meubles

| | cm | cm |
|---------|--------|----|
| 00463 4 | Ø 30,5 | 9 |



passende Abdeckhaube
06510

Einzelteile / spare parts / piezas sueltas / pièces détachées



Frischhalte-Haube / cover / campana / cloche

| | | |
|---------|------|------|
| 06510 9 | Ø 30 | 11,5 |
|---------|------|------|



drehbar

Servierplatte / Tortenplatte
plate / cake plate
porta tartas
guéridon à gâteau



Fuß matt poliert, drehbar, möbelschonende Moosgummi-Unterseite
 foot satin polished finish, rotating, foam rubber below to save your furniture
 vidrio, pie inox satinado giratorio, base de goma para proteger el mobiliario
 plateau en verre, pied tournant inox poli satin, revêtement mousse sous le pied anti-rayures

| | cm | cm |
|---------|------|----|
| 00444 3 | Ø 30 | 7 |



Servierplatte
plate
porta tarta
guéridon à gâteau



Fuß matt poliert, stabil und sehr standsicher
 foot satin polished finish
 pie pulido con efecto satinado
 inox poli satin

| | cm | cm |
|---------|------|----|
| 00464 1 | Ø 30 | 11 |



Tortenplatte
cake plate
porta tarta
guéridon à gâteau



Fuß hochglanzpoliert, Platte matt poliert, stabil und sehr standsicher
 foot mirror polished finish, plate satin polished finish
 pie pulido brillante, bandeja pulida mate
 pied brillant, plateau poli satin mat

| | | | |
|---------|------|------|--|
| | cm | ↑ cm | |
| 00462 7 | Ø 30 | 11 | |

Einzelteile / spare parts / piezas sueltas / pièces détachées



Frischhalte-Haube / cover / campana / cloche

| | | | |
|---------|------|----|--|
| 06501 7 | Ø 30 | 11 | |
|---------|------|----|--|

Konditorplatte
cake plate
porta tartas confitería
plateau à gâteaux avec pied



matt poliert
 satin polished finish
 acabado efecto satinado
 poli mat effet satin

| | | | |
|---------|------|------|--|
| | cm | ↑ cm | |
| 00046 9 | Ø 31 | 3 | |

Tortenplatte
cake tray
bandeja para tarta
plat à tarte

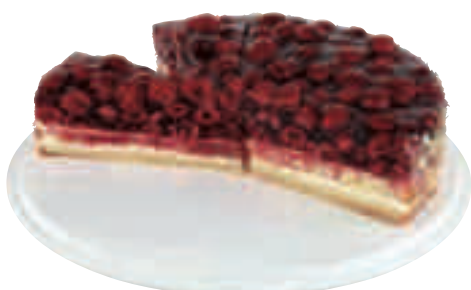

00468

Rand fixiert die Haube, mit Antirutsch-Füßchen
 carved edge fixes the cover, non-slip feet
 ranura para fijar bien la campana, pies antideslizantes
 bord rainuré pour maintien ferme de la cloche, pieds anti-glisce

| | | | |
|---------|------|------|---|
| | cm | ↑ cm | |
| 00468 9 | Ø 31 | 4 | ○ |
| 00469 6 | Ø 31 | 4 | ● |



00469

Einzelteile / spare parts / piezas sueltas / pièces détachées



Frischhalte-Haube / cover / campana / cloche

| | | | |
|---------|------|-----|--|
| 06504 8 | Ø 30 | 9,5 | |
|---------|------|-----|--|

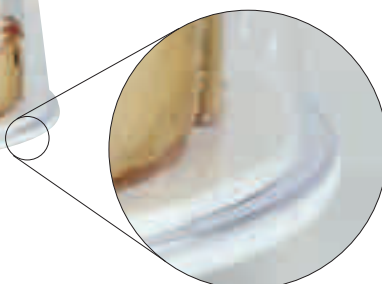

Abgesenkter Rand fixiert die Haube und vereinfacht das Abheben von Tortenstücken. Kein Abrutschen der Haube.

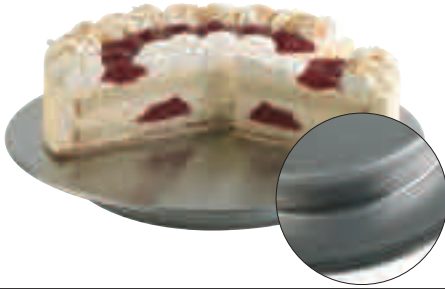

Konditorplatte „PRO“
cake plate
porta tartas
présentoir à gâteaux



matt poliert
 satin polished finish
 acabado pulido efecto satinado
 poli mat effet satin

| | ☐ cm | ↑ cm | 📦 kg |
|---------|------|------|------|
| 00465 8 | Ø 31 | 4 | 1,13 |



Tortenplatte
cake plate with cover
bandeja tarta con campana
plat à tarte avec cloche



mit Haube einzeln eingeschweißt, mit Farbeinleger
 with cover, with colour inlay
 retractilada con la campana, con foto color
 filmé avec la cloche, avec photo couleur

7cm Haubenhöhe + 11cm Haubenhöhe

| | ☐ cm | ↑ cm | |
|---------|------|--------|-----------------------------|
| 00065 0 | Ø 30 | 11 | mit 1 Haube / with 1 cover |
| 00652 2 | Ø 30 | 7 + 11 | mit 2 Hauben / with 2 cover |



Tortenplatte „BAROK“
cake plate
bandeja tartas
plat à gâteau



2-teilig: Tortenplatte mit Barock-Rand + Haube (extra stabil)
 2 pcs. set: cake plate with decor edge „Barok“ + cover (extra robust)
 set 2 piezas: porta tartas, borde decor „Barok“ + campana (extra fuerte)
 Set 2 pcs: plateau bord décor „Barok“ + cloche ultra-résistante

| | ☐ cm | ↑ cm |
|---------|------|------|
| 06503 1 | Ø 32 | 10 |

Einzelteile / spare parts / piezas sueltas / pièces détachées

Frischhalte-Haube / cover / campana / cloche

| | | |
|---------|------|-----|
| 06504 8 | Ø 30 | 9,5 |
|---------|------|-----|



Tablett mit Haube
tray with cover
bandeja con campana
plateau avec cloche



| | ☐ cm | ↑ cm |
|---------|-----------|------|
| 00064 3 | 34 x 16,5 | 10 |
| 00067 4 | 25 x 19 | 7 |

Einzelteile / spare parts / piezas sueltas / pièces détachées

Haube für 00064 / cover for 00064 / campana para 00064 / cloche pour 00064

| |
|---------|
| 06401 0 |
|---------|

Haube für 00067 / cover for 00067 / campana para 00067 / cloche pour 00067

| |
|---------|
| 06701 1 |
|---------|

00064
Königskuchenplatten

00067
Frischhaltebox

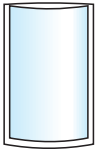

doppelwandig
double wall



Thermo-Sauciere
insulated sauce boat
salsera isotérmica
saucière thermique



doppelwandig, Klappdeckelverschluss, Einhandbedienung
double wall, hinged cover, one-hand operation
doble pared, tapa con bisagra, se maneja con 1 mano
double paroi, couvercle avec charnière, usage 1 main

| | □ cm | ↑ cm | ltr. |
|---------|-----------|------|------|
| 40207 2 | 19 x 12,5 | 13 | 0,4 |



3 Größen

Sauciere
gravy boat
salsera
saucière

hochglanzpoliert, extra schwere Qualität
mirror polished finish, high quality
acabado efecto espejo, alta calidad, base pesada
poli brillant, belle qualité, pied pesant

| | □ cm | ↑ cm | ltr. |
|---------|-----------|------|------|
| 40204 1 | 16 x 7,5 | 9,0 | 0,15 |
| 40205 8 | 19 x 9,0 | 13,0 | 0,25 |
| 40206 5 | 22 x 10,5 | 13,5 | 0,45 |



4 Größen

Sauciere
gravy boat
salsera
saucière

poliert
polished
pulido
poli

| | □ cm | ↑ cm | ltr. |
|---------|----------|------|------|
| 40200 3 | 14 x 6 | 7 | 0,1 |
| 40201 0 | 22 x 9,5 | 10 | 0,2 |
| 40202 7 | 20 x 9 | 10,5 | 0,3 |
| 40203 4 | 17 x 7,5 | 8,7 | 0,15 |



15925



15926

**Butterservierer
butter dish
mantequillera
beurrier**



| | ▣ cm | ↑ cm |
|---------|-------|------|
| 15925 9 | Ø 9 | 9 |
| 15926 6 | 9 x 9 | 9 |



**Butterservierer
butter dish
mantequillera
beurrier**



hochglanzpoliert
mirror polished finish
acabado brillante
poli brillant

| | ▣ cm | ↑ cm |
|---------|------|------|
| 15921 1 | Ø 9 | 7 |



**Kühlschrank-Butterdose
refrigerator butter dish
mantequillera para nevera
boîte à beurre pour le frigo**



| | ▣ cm | ↑ cm |
|---------|----------|------|
| 00063 6 | 16 x 9,5 | 5,5 |



**Butterdose
butter dish
mantequillera
beurrier**



| | ▣ cm | ↑ cm |
|---------|-------------|------|
| 00062 9 | 18,5 x 12,5 | 5 |

NEW



Eierbecher, 4er Set
egg holder, 4pcs. set
huevera, set de 4 unidades
coquetier, pack de 4



| | □ cm | ↑ cm | pcs. |
|---------|------|------|------|
| 83851 2 | ∅ 8 | 3 | 4 |



4er Set
 weiß
 83848

Eierbecher, 4er Set
egg holder, 4 pcs. set
huevera, set de 4 unidades
coquetier, pack de 4



| | □ cm | ↑ cm | pcs. |
|---------|-------|------|------|
| 83848 2 | ∅ 8,5 | 2 | 4 |



Eierbecher
egg holder
huevera
coquetier



hochglanzpoliert / mirror polished finish / acabado pulido efecto espejo / effet miroir

| | □ cm | ↑ cm |
|---------|-------|------|
| 00032 2 | ∅ 8,5 | 2 |

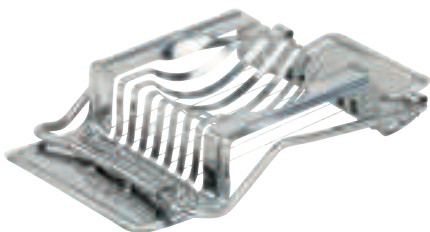

Eierschneider
egg cutter
cortahuevos
coupe-oeufs



zum Längs- und Querteilen von hart gekochten Eiern
 to cut hard-boiled eggs
 corta a rodajas un huevo duro
 en rondelles

| | □ cm | ↑ cm |
|---------|----------|------|
| 88099 3 | 14,5 x 8 | 2,5 |



Eier-Korb
egg basket
cesta de huevos
panier à oeufs



stabile Vollweide, hält den Inhalt durch das sehr dicht verarbeitete Stoff-Futter lange warm
 willow, stable, keeps eggs warm
 ratán, calidad fuerte, mantiene los huevos calientes
 rotin, résistant, belle qualité, pour maintenir les oeufs bien chauds

| | □ cm | ↑ cm |
|---------|------|------|
| 30299 0 | ∅ 26 | 17 |



2 Größen
 Ø 10 cm für Gläser
 Ø 11,5 cm für Flaschen

**Untersetzer
 coaster
 posavasos
 plateau sous-verre**



hochglanzpoliert, schwere Ausführung, Rand eingerollt
 mirror polished finish, heavy quality, rolled edge
 acabado pulido efecto espejo, alta calidad, borde redondeado
 effet miroir, bord rond, qualité extra

| | cm | pcs. | |
|---------|--------|------|---|
| 35711 2 | Ø 10 | 6 | für Gläser / for glasses para vasos / pour les verres |
| 35712 9 | Ø 11,5 | 2 | für Flaschen / for bottles para botellas / pour les bouteilles |



35912
 Rand eingerollt

**Untersetzer
 coaster
 posavasos
 plateau sous-verre**



Rand eingerollt
 rolled edge
 borde redondeado
 bord rond

| | cm | pcs. |
|---------|------|------|
| 35912 3 | Ø 12 | 6 |



Ø 12 cm

40100

**Servier- / Beilagenschale
 serving dish
 fuente honda
 plat creux pour la table**



hochglanzpoliert
 mirror polished finish
 acabado pulido efecto espejo
 effet miroir

| | cm | ↑ cm | ltr. |
|---------|------|------|------|
| 40100 6 | Ø 12 | 3,5 | 0,2 |
| 40101 3 | Ø 14 | 4 | 0,4 |
| 40102 0 | Ø 16 | 4 | 0,5 |
| 40103 7 | Ø 18 | 4,5 | 0,8 |
| 40104 4 | Ø 20 | 5 | 1,3 |
| 40105 1 | Ø 22 | 5,5 | 1,5 |

Ø 16 cm



40102

Ø 22 cm



40105



**Rechnungstablett, 2er Set
bill presenter, 2 pcs. set
set 2 piezas para presentar cuenta
porte-addition**



1 Edelstahl-Tablett hochglanzpoliert + 1 klappbare Ledermappe mit Stiftflasche, mit Magnethalterung
 1 stainless tray mirror polished finish + 1 leather presenter, with magnetic system
 1 bandeja de acero inoxidable pulido brillante, 1 presentador de cuero con sistema magnético

| | cm | cm |
|---------|---------|----|
| 30109 2 | 20 x 16 | 2 |



**Rechnungstablett
bill tray
bandeja porta-cuenta
plateau addition**



mit Klemme für Rechnung
 with clip for bill
 con clip para la nota
 avec pince

| | cm | cm |
|---------|---------|----|
| 30110 8 | 17 x 11 | 1 |



**Rechnungstablett
bill presenter
presentar cuenta
porte-addition**



mit Schriftzug „Thank You“
 with print „Thank You“
 con las palabras „Thank You“
 avec des mots „Thank You“

| | cm | cm |
|---------|-------------|-----|
| 30107 8 | 16,5 x 11,5 | 0,5 |



**Rechnungstablett
bill presenter
presentar cuenta
porte-addition**



mit Klemme für Rechnung
 with clip for bill
 con clip para la nota
 avec clip pour la note

| | cm | cm |
|---------|-------------|-----|
| 30108 5 | 20,0 x 12,0 | 0,5 |



Tablett „BISTRO“
tray
bandeja
plateau



rutschfest, mit 2 Griffmulden und Stapelrand
non-slip, two open handles, stackable edge
anti-deslizante, 2 asas
anti-dérapant, 2 anses

| | ☐ cm | ↑ cm | |
|---------|--------|------|---|
| 84045 4 | Ø 35,5 | 4,5 | ● |

rutschfest, hoher Rand
non-slip, high edge



3 Größen
3 sizes

Tablett „GASTRO“
tray
bandeja
plateau



rutschfeste Oberfläche
non-slip surface
superficie anti-deslizante
surface anti-dérapante

| | ☐ cm | ↑ cm | |
|---------|--------|------|---|
| 00547 1 | Ø 27,5 | 2 | ● |
| 00548 8 | Ø 35,5 | 2 | ● |
| 00549 5 | Ø 40,5 | 2 | ● |

rutschfest
non-slip

Serviertablett „HAPPY HOUR“
tray
bandeja
plateau



rutschfest, glasfaserverstärktes Polyester, rutschfeste Naturkautschukbeschichtung
non-slip, fibreglass reinforced polyester, natural rubber coating
antideslizante, poliéster fibra de vidrio, revestido caucho natural
anti-glisse, polyester renforcé avec fibre de verre, revêtement caoutchouc naturel

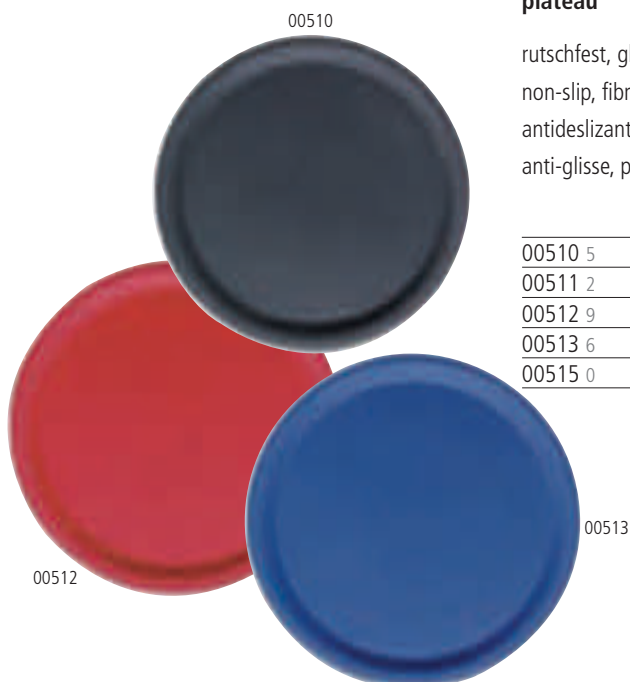

| | ☐ cm | ↑ cm | |
|---------|------|------|---|
| 00510 5 | Ø 32 | 1,5 | ● |
| 00511 2 | Ø 38 | 1,5 | ● |
| 00512 9 | Ø 38 | 1,5 | ● |
| 00513 6 | Ø 38 | 1,5 | ● |
| 00515 0 | Ø 43 | 1,5 | ● |



Bierglasträger „RUTSCHFEST“
tray non-slip
bandeja antideslizante
anti-glisse



glasfaserverstärktes Polyester, rutschfeste Naturkautschukbeschichtung, -50°C bis +140°C
 fiberglass reinforad polyester, -50°C to +140°C, natural rubber coating
 poliester reforzado con fibra de vidrio desde -50°C hasta 140°C
 polyester renforcé avec fibre de verre, revêtement caoutchouc naturel, résistant -50°C a 140°C

| | ☐ cm | ↑ cm | | |
|---------|---------|------|---|---|
| 00500 6 | Ø 36 | 3,5 | ● | rund - anthrazit / round - anthracite rendonda-antracita / rond - anthracite |
| 00501 3 | Ø 36 | 3,5 | ● | rund - grau / round - grey redonda-gris / rond - gris |
| 00506 8 | 28 x 20 | 1,5 | ● | oval - anthrazit / oval - anthracite oval-antracita / ovale - anthracite |
| 00507 5 | 28 x 20 | 1,5 | ● | oval - grau / oval - grey oval-gris / ovale - gris |

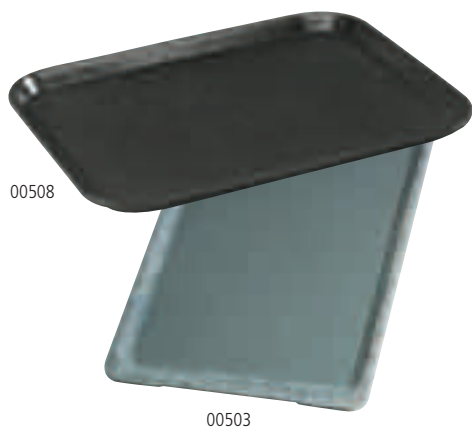

Serviertablett „RUTSCHFEST“
tray non-slip
bandeja antideslizante
anti-glisse



glasfaserverstärktes Polyester, rutschfeste Naturkautschukbeschichtung
 fiberglass reinforced polyester, non-slip natural rubber coating
 antideslizante, poliéster fibra de vidrio, revestido caucho natural
 anti-glisse, polyester renforcé avec fibre de verre, revêtement caoutchouc naturel

| | ☐ cm | ↑ cm | GN | |
|---------|-------------|------|-----|---|
| 00502 0 | 53,0 x 32,5 | 1,5 | 1/1 | ● |
| 00508 2 | 46 x 36 | 2 | | ● |
| 00505 1 | 53,0 x 32,5 | 1,5 | 1/1 | ● |
| 00503 7 | 53 x 37 | 1,5 | | ● |



Fast Food-Tablett
snack tray
bandeja autoservicio y snacks
plateau self-service et snacks



| | ☐ cm | ↑ cm | |
|---------|-----------|------|---|
| 00530 3 | 35 x 27 | 2 | ● |
| 00531 0 | 35 x 27 | 2 | ● |
| 00532 7 | 35 x 27 | 2 | ● |
| 00533 4 | 35 x 27 | 2 | ● |
| 00535 8 | 41 x 30,5 | 2 | ● |
| 00536 5 | 41 x 30,5 | 2 | ● |
| 00537 2 | 41 x 30,5 | 2 | ● |
| 00538 9 | 41 x 30,5 | 2 | ● |
| 00540 2 | 45 x 35,5 | 2 | ● |
| 00541 9 | 45 x 35,5 | 2 | ● |
| 00542 6 | 45 x 35,5 | 2 | ● |
| 00543 3 | 45 x 35,5 | 2 | ● |

NEW

Tablett „CROCO“

Tray
Bandeja
Plat



Edelstahl, hochglänzend, doppelwandig, innen: Krokodillederoptik
stainless-steel, mirror polished finish, double-wall
acero inoxidable, pulido brillante, doble pared
inox, brillant, double paroi

| | □ cm | ↑ cm |
|---------|------|------|
| 01337 7 | Ø 32 | 4 |



Serviertablett „COOL“

tray
bandeja
plateau



rutschfeste Oberfläche
non-slip surface
superficie anti-deslizante
surface anti-dérapante

| | □ cm | ↑ cm | |
|---------|--------|------|---|
| 00551 8 | Ø 35,5 | 2 | weiß / schwarz / braun white / black / brown |

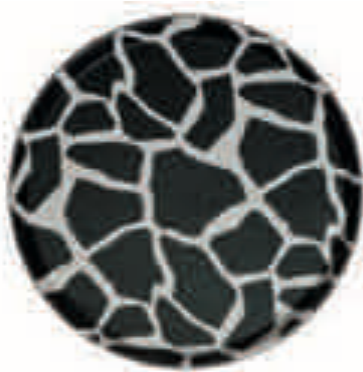

Serviertablett „FLASH“

tray
bandeja
plateau



rutschfeste Oberfläche
non-slip surface
superficie anti-deslizante
surface anti-dérapante

| | □ cm | ↑ cm | |
|---------|--------|------|---------------------------------|
| 00550 1 | Ø 35,5 | 2 | schwarz / weiß black / white |



oval

Tablett oval
tray oval
bandeja
plat



rutschfest, Holzdekor-Laminat
non-slip, coated wood
antideslizantes
anti-dérapante

| | ▣ cm | ↑ cm | |
|---------|-------------|------|--|
| 00520 4 | 23,0 x 16,0 | 1,0 | |
| 00521 1 | 26,0 x 20,0 | 1,0 | |
| 00522 8 | 29,0 x 21,0 | 1,0 | |
| 00523 5 | 38,0 x 27,0 | 1,5 | |



rutschfest
non-slip



00528
Ø 31 cm

Tablett rund
tray
bandeja
plat



rutschfest, Woodform, Mahagoni
non-slip, woodform, mahogany
antideslizantes
anti-dérapante

| | ▣ cm | ↑ cm | |
|---------|--------|------|---------------------------------|
| 00528 0 | Ø 31 | 3,5 | hoher Rand |
| 00529 7 | Ø 35,5 | 3,5 | hoher Rand |
| 00527 3 | Ø 32 | 1,5 | flacher Rand, Holzdekor-Laminat |



00529
Ø 35,5 cm



00527
Ø 32 cm

flacher Rand / flat edge



00526

Tablett rechteckig
tray
bandeja
plat



rutschfest, Holzdekor-Laminat
non-slip, coated wood
antideslizantes
anti-dérapante

| | ▣ cm | ↑ cm | |
|---------|-------------|------|--|
| 00524 2 | 43,5 x 31,5 | 1,5 | |
| 00525 9 | 52,0 x 39,0 | 1,5 | |
| 00526 6 | 60,5 x 42,5 | 1,5 | |

designed by **CULTURE FORM**

Serviertablett „KAFFEEHAUS“
tray
bandeja
tablette



84251

| | ▣ cm | ↑ cm | |
|---------|-------------|------|---|
| 84250 2 | 26,0 x 20,0 | 1,5 | ○ |
| 84252 6 | 28,5 x 21,5 | 1,5 | ○ |
| 84251 9 | 26,0 x 20,0 | 1,5 | ● |
| 84253 3 | 28,5 x 21,5 | 1,5 | ● |

rutschfeste Oberfläche
non-slip surface
superficie anti-deslizante
surface anti-dérapante



84252

designed by **CULTURE FORM**



Serviertablett „KAFFEEHAUS“
tray
bandeja
plateau



mattiert
30126 + 30127

| | ▣ cm | |
|---------|-------------|---|
| 30126 9 | 25,5 x 19,5 | mattiert / satin polished finish acabado efecto satinado / fini mat effet satin |
| 30127 6 | 30 x 23 | mattiert / satin polished finish acabado efecto satinado / fini mat effet satin |
| 30136 8 | 25,5 x 19,5 | hochglanzpoliert / mirror polished finish acabado espejo pulido / poli brillant miroir |
| 30137 5 | 30 x 23 | hochglanzpoliert / mirror polished finish acabado espejo pulido / poli brillant miroir |



hochglanzpoliert
30136 + 30137



stabiler
ingerollter
Rand

Serviertablett „KAFFEEHAUS“
tray
bandeja
plateau



matt poliert, Rand ingerollt, mit Farbeinleger
satin polished finish, rolled edge, with colour inlay
acabado pulido satinado, borde redondeado, presentación foto color
effet satin mat, bord rond, présentation photo couleur

| | ▣ cm | ↑ cm |
|---------|---------|------|
| 30119 1 | 23 x 23 | 1,5 |



stabiler
eingerollter
Rand

Serviertablett „KAFFEEHAUS“
tray
bandeja
plateau



matt poliert, Rand eingerollt, mit Farbeinleger
satin polished finish, rolled edge, with colour inlay
acabado pulido efecto satinado, borde redondeado
effet satin, bord rond

| | cm | cm |
|---------|-----------|-----|
| 30118 4 | 21,5 x 13 | 1,5 |



matt poliert / satin polished

Serviertablett „KAFFEEHAUS“
tray
bandeja
plateau



matt poliert, oval, Rand eingerollt
satin polished finish, oval, rolled edge
pulido acabado efecto satinado, oval, borde redondeado
effet satin, ovale, bord rond

| | cm | |
|---------|-----------|--|
| 30111 5 | 19 x 15 | für Zucker und Sahne / for sugar and cream para azúcar y crema / pour le sucre et la crème |
| 30112 2 | 26,5 x 19 | für eine Tasse / for one cup para una taza / pour 1 tasse |
| 30113 9 | 29 x 22 | für zwei Tassen / for two cups para dos tazas / pour 2 tasses |
| 30123 8 | 23 x 17,5 | Eisdielen-Größe / icecream pralor size Tamaño especial para heladerías / taille spéciale pour glaciers |



hochglanzpoliert / mirror polished

hochglanzpoliert, oval, Rand eingerollt
mirror polished finish, oval, rolled edge
pulido efecto espejo, ovalado, borde redondeado
effet brillant, ovale, bord rond

| | | |
|---------|-----------|--|
| 30115 3 | 19 x 15 | für Zucker und Sahne / for sugar and cream para azúcar y crema / pour le sucre et la crème |
| 30116 0 | 26,5 x 19 | für eine Tasse / for one cup para una taza / pour 1 tasse |
| 30117 7 | 29 x 22 | für zwei Tassen / for two cups para dos tazas / pour 2 tasses |
| 30124 5 | 23 x 17,5 | Eisdielen-Größe / icecream pralor size Tamaño especial para heladerías / taille spéciale pour glaciers |

**HOT
PRICE**



Serviertablett „KAFFEEHAUS“
tray
bandeja
plateau



Rand eingerollt, Innenfläche ziseliert, einzeln im Beutel mit verkaufsförderndem Farbeinleger
rolled edge, bulk packed with colour inlay
borde redondeado, superficie decor relieve, presentación con foto color
bord rond, surface entièrement ciselée. Présentation sachet indiv. Et photo couleur

| | cm | pcs. |
|---------|---------|------|
| 30114 6 | 30 x 22 | 48 |



Kühlschale, 2-teilig „COOL“
cool bowl, 2 pcs. set
bol refrigerado, 2 pz.
set de 2 bols réfrigérés



2-teilig, doppelwandig, Schale ist mit Kühlmittel gefüllt und wird zum Aufladen in das Gefrierfach gelegt, endlos verwendbar

2 pcs., 1 pc. double wall ice bowl filled with freezer-liquid, 1 pc. stainless bowl

bol isotérmico doble pared que contiene un líquido refrigerante, a acumula el frío en el congelador para luego mantener fríos los alimentos, para usos repetitivos

bol isotherme double paroi qui contient un liquide réfrigérant, a cumule le froid du congélateur pour ensuite maintenir froids les aliments, pour usages répétés



| | □ cm | ↑ cm | litr. |
|---------|------|------|-------|
| 30023 1 | Ø 23 | 10,5 | 1 |

Einzelteile / spare parts / piezas sueltas / pièces détachées

Deckel, SAN mit Löffelaussparung / cover, SAN / tapa, SAN / couvercle, SAN

| | | | |
|---------|--------|-----|--|
| 83920 5 | Ø 20,5 | 1,3 | |
|---------|--------|-----|--|



passender Deckel
83920

Kühldauer bis
zu 3 Stunden

Kaviarkühler
caviar cooler
enfriador de caviar
rafraîchisseur de caviar



4-teilig; Glasschale Ø 10 cm

4 pcs., glass bow Ø 10 cm

4 piezas, bol Ø 10 cm

4 éléments, bol Ø 10 cm

| | □ cm | ↑ cm | |
|---------|------|------|--|
| 01699 6 | Ø 18 | 12 | |

Serviertopf Muschel
mussel port
mejillonera
casserole à moules



schwarz emailliertes Stahlblech, mit Edelstahlrand

black enamelled steel, stainless steel rim

hierro esmaltado negro, borde inox

acier émaillé noir, bord inox

Topf darf nicht erhitzt werden!
Topf ist nicht zum Kochen geeignet!



| | □ cm | ↑ cm | litr. |
|---------|--------|------|-------|
| 00623 2 | Ø 13,5 | 9 | 0,8 |
| 00625 6 | Ø 18 | 12 | 2,0 |
| 00626 3 | Ø 20 | 13 | 3,0 |
| 00627 0 | Ø 24 | 13,5 | 4,0 |

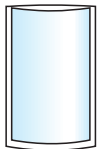

doppelwandig
double wall



3 Größen



Edelstahlschale, doppelwandig
stainless bowl, double wall
bol inox doble pared
bol inox double paroi



beste Isoliereigenschaften
best insulating properties
muy aislante
très isolant

| | □ cm | ↑ cm | ltr. |
|---------|------|------|------|
| 30040 8 | Ø 14 | 6,5 | 0,5 |
| 30041 5 | Ø 20 | 9 | 1,5 |
| 30042 2 | Ø 23 | 10 | 2,5 |

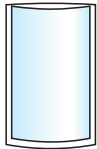

doppelwandig
double wall



1,8 ltr.



Topf, doppelwandig
bowl, double wall
salsera alta doble pared
pot à sauce double paroi



beste Isoliereigenschaften
best insulating properties
muy aislante
très isolant

| | □ cm | ↑ cm | ltr. |
|---------|------|------|------|
| 30043 9 | Ø 15 | 18 | 1,8 |



6 Löffel

Gourmetlöffel, 6er Set
gourmet spoons, 6 pcs. set
cucharas gourmet, el pack de 6
cuillères gourmet, le pack de 6



hochglanzpoliert, zur Präsentation von Vorspeisen
mirror polished finish, perfect to present appetiser
acabado brillante, perfecto para presentar aperitivos
poli brillant, parfait pour les apéritifs et entrées

| | □ cm | pcs. |
|---------|--------|------|
| 00682 9 | 11 x 4 | 6 |



6er Set:
3 stehende + 3 liegende Gabeln

Canapee-Gabeln, 6er Set
canapé forks, 6 pcs. set
tenedores canapé, el pack de 6
fourchettes a canapés, le pack de 6



6-teilig: 3 stehende Gabeln 7 x 3 x 4 cm + 3 liegende Gabeln 11,5 x 2,5 x 1,5 cm
6 pcs. set: 3 forks standing 7 x 3 x 4 cm + and 3 forks lying 11,5 x 2,5 x 1,5 cm
set de 6 piezas: 3 tenedores de pie, 7 x 3 x 4 cm + tres tenedores tumbados, 11,5 x 2,5 x 1,5 cm
Set 6 pièces: 3 fourchettes 7 x 3 x 4 cm + 3 fourchettes 11,5 x 2,5 x 1,5 cm

| | pcs. |
|---------|------|
| 16905 0 | 6 |



Dressingtopf
dressing pot
salsera
pot à sauce



Deckel mit Löffelaussparung
 cover notched for spoon
 tapa agujereada para el cucharón
 couvercle avec espace pour la louche

| | □ cm | ↑ cm | ltr. |
|---------|--------|------|------|
| 83309 8 | Ø 18,5 | 17 | 2,3 |
| 83310 4 | Ø 17 | 15 | 2,0 |
| 83311 1 | Ø 13 | 13 | 0,8 |



Servier- / Buffetplatte
dish
bandeja buffet
plat buffet



| | □ cm | ↑ cm | GN |
|---------|-------------|------|-----|
| 83301 2 | 53 x 32,5 | 2 | 1/1 |
| 83305 0 | 32,5 x 26,5 | 2 | 1/2 |
| 83304 3 | 32,5 x 17,5 | 2 | 1/3 |
| 83303 6 | 53 x 16,2 | 2 | 2/4 |



Buffet & Banquet . Cerealienspender . Etagèren . Kühlschalen . Kannen . Saftdispenser . Buffet-Pyramide
buffet & banquet . cereal dispenser . etagèren . cool bowls . pitcher . juice dispenser . buffet pyramid
buffet y catering . expositores . bol refrigerado . jarras . dispensadores de zumos . piràmide buffet
buffet et catering . présentoirs . bol réfrigéré . pichets . distributeurs de jus de fruit . pyramide buffet

BRIDGE designed by CULTURE FORM



Der „Alleskönner“ für Ihr Buffet!

Mit hohem Anspruch an Design und Funktionalität haben wir das Buffet-System „Bridge“ für Sie entwickelt. Die perfekt aufeinander abgestimmten Komponenten unterstützen die Präsentation Ihrer Speisen und ermöglichen Ihnen den unkomplizierten Aufbau Ihrer einzigartigen Buffet-Landschaften. Die in den Holzoberflächen Ahorn und Wenge erhältlichen Artikel sind in ihren Höhen und ihren Volumina optimal aufeinander abgestimmt und gewährleisten einen einfachen und sicheren Umgang in Ihrem Gastronomiealltag.

The collection "Bridge" is bringing perfectly coordinated components for an uncomplicated and organized buffet system, finalizing in an unique buffet scenery. All pieces combine perfectly with one another in their variations of sizes and volumes. The wooden items are available in 2 colors, maple or wenge. A simple and safe handling is guaranteed.

Una colección universal para un buffet único: un sistema funcional y fácil de componer, asociado a la elegancia de su exclusivo diseño. Los elementos se combinan a la perfección entre variaciones de alturas y volúmenes, realizando sus propuestas y composiciones culinarias y modelando el paisaje del buffet. Las piezas están disponibles en 2 colores, wengue o arce. Manejo sencillo y seguro.

Une collection universelle pour une présentation unique de votre buffet : fonctionnel et facile à composer, ce système est à la fois pratique, simple et spectaculaire par son élégant design. Les différents éléments se marient à la perfection pour construire sans difficulté différentes compositions, variant les hauteurs et les volumes et mettant en valeur vos créations culinaires. Vous pouvez modeler vous-même votre buffet comme un paysage. Les pièces sont disponibles en deux couleurs, bois wengué ou érable. Manipulation aisée et sûre.



13990
Ahorn



14990
Wenge

Tablets und Behälter bis 100mm einsetzbar

GN 1/1, GN 1/2, GN 1/3

Kühlbox „BRIDGE“ refrigerated buffet display set de buffet refrigerado présentoir buffet froid



Set bestehend aus: 1 Gestell aus Ahorn oder Wenge, 1 Behälter aus Kunststoff, 1 GN 1/1 Tablett aus Melamin, 1 Kühlakku, 1 Rolltophaube (fix montiert)

set consists of: 1 base element maple or wenge, 1 plastic insert black, 1 GN 1/1 tray melamine, 1 cooler, 1 cover (fixed)

incluye: soporte de madera en arce o wengue, 1 cubeta de plástico, 1 bandeja de melamina GN 1/1, 1 placa de frío GN 1/1, 1 campana rolltop (fija)

support bois en érable ou wengué, 1 bac plastique, 1 plat mélamine GN 1/1, 1 plaque de froid GN 1/1, 1 cloche rolltop (fixe)

| | □ cm | ↑ cm | | |
|---------|-------------|------|-------|---|
| 13990 9 | 63,5 x 42,5 | 31 | Ahorn | ● |
| 14990 8 | 63,5 x 42,5 | 31 | Wenge | ● |



Kühlschale „BRIDGE“ cooling bowl bol refrigerado bol réfrigéré



Set bestehend aus: 1 Gestell aus Ahorn oder Wenge, 1 Behälter aus Edelstahl, 1 Schale aus Melamin (Ø 14 cm o. Ø 23 cm), 1 Kühlakku

set consists of: 1 base element maple or wenge, 1 bowl stainless, 1 bowl melamine (Ø 14 cm o. Ø 23 cm), 1 cooler

| | □ cm | ↑ cm | ltr. | | |
|---------|-------------|------|------|-------|---|
| 13980 0 | 18,5 x 18,5 | 10 | 0,50 | Ahorn | ● |
| 13981 7 | 27,5 x 27,5 | 14 | 2,50 | Ahorn | ● |
| 14980 9 | 18,5 x 18,5 | 10 | 0,50 | Wenge | ● |
| 14981 6 | 27,5 x 27,5 | 14 | 2,50 | Wenge | ● |

passender Deckel:
10890 Ø 14 cm
10887 Ø 23 cm



Buffet. Banquet
buffet. banquet

Einzelteile / spare parts / piezas sueltas / pièces détachées

Edelstahlschale / bowl / bols / bols



| | □ cm | ↑ cm | |
|---------|------|------|--|
| 30050 7 | Ø 14 | 8,5 | |
| 30052 1 | Ø 23 | 13,5 | |

30050, 30052



Melaminschale / bowl / bols / bols



| | □ cm | ↑ cm | ltr. | |
|---------|------|------|------|---|
| 83700 3 | Ø 14 | 6,5 | 0,50 | ○ |
| 83701 0 | Ø 14 | 6,5 | 0,50 | ● |
| 83702 7 | Ø 23 | 10,5 | 2,50 | ○ |
| 83703 4 | Ø 23 | 10,5 | 2,50 | ● |

83700, 83702



83701, 83703



Deckel / cover / tapa / couvercle



| | □ cm | |
|---------|------|--|
| 10890 5 | Ø 14 | |
| 10887 5 | Ø 23 | |

10887



10890



Kühlakku / cooler / acumulador de frío / accumulateur de froid

| | □ cm | ↑ cm |
|---------|--------|------|
| 10781 6 | Ø 10,5 | 2,5 |
| 10777 9 | Ø 15 | 2,5 |

designed by **CULTURE FORM**

Cerealienspender „BRIDGE“
cereal dispenser
dispensador de cereales
distributeur de céréales



Behälter herausnehmbar, „Feierabend-Deckel“ für das aromadichte Lagern, portionieren durch einfaches Drehen

removable canister, special lid to keep the cereals fresh, easy to use, rotate the button to get the muesli

contenedor movable, tapa especial para mantener los cereales frescos, fácil de usar, se gira el pomo para servir los cereales

réceptif amovible, couvercle spécial pour conserver les céréales, usage facile en tournant le bouton



13987
Ahorn

14987
Wenge

| | ☐ cm | ↑ cm | ltr. | | |
|---------|---------|------|------|-------|---|
| 13987 9 | 21 x 20 | 55,5 | 4,5 | Ahorn | ● |
| 14987 8 | 21 x 20 | 55,5 | 4,5 | Wenge | ● |

designed by **CULTURE FORM**

Saftdispenser „BRIDGE“
juice dispenser
dispensador de zumo
distributeur à jus de fruit



Kühlung durch 2 Kühllakkus von oben und unten

cooling with 2 cooling elements from the top and base

2 acum. de frío (1 en la base y 1 en la tapa)

2 plaques de froid (1 dans le couvercle, 1 dans le socle)



10873
Wenge

10870
Ahorn

| | ☐ cm | ↑ cm | ltr. | | |
|---------|-------------|------|------|-------|---|
| 10870 7 | 31,0 x 20,0 | 42 | 4 | Ahorn | ● |
| 10871 4 | 35,5 x 22,0 | 50 | 6 | Ahorn | ● |
| 10872 1 | 31,0 x 20,0 | 42 | 4 | Wenge | ● |
| 10873 8 | 35,5 x 22,0 | 50 | 6 | Wenge | ● |



inkl. 3 Magnetschilder:
 „ORANGE“
 „APPLE“
 „GRAPEFRUIT“

designed by **CULTURE FORM**

Besteckbehälter „BRIDGE“
cutlery organizer
cubeta para cubiertos
bac à couverts



2 teiliges Set: 1 Gestell aus Ahorn oder Wenge, 1 Besteckbehälter (Nr. 11955), herausnehmbar
2 pcs set: 1 base element maple or wenge, 1 removable plastic container (item 11955)
Set de 2 piezas: soporte madera arce o wengue + 1 cubeta extra'ble 4 compartimentos de plástico (ref. 11955)
set de 2 pcs: support bois en érable ou wengué + 1 bac plastique amovible à 4 compartiments (réf. 11955)

| | □ cm | ↑ cm | | |
|---------|-------------|------|-------|---|
| 13995 4 | 57,5 x 47,0 | 12 | Ahorn | ● |
| 14995 3 | 57,5 x 47,0 | 12 | Wenge | ● |

designed by **CULTURE FORM**

Konferenzkühler „BRIDGE“
bottle cooler
enfriador
refraîchisseur



13985
Ahorn



14985
Wenge

2-teiliges Set, bestehend aus: 1 Gestell aus Ahorn oder Wenge, 1 Behälter aus Edelstahl (doppelwandig)
2 pcs set: 1 base element maple or wenge, 1 bowl stainless steel (double-wall)
Set de 2 piezas: soporte madera arce o wengue, champañera inox de doble pared
Set de 2 pcs: support bois en érable ou wengue, seau inox double paroi

| | □ cm | ↑ cm | | |
|---------|---------|------|-------|---|
| 13985 5 | 35 x 35 | 19 | Ahorn | ● |
| 14985 4 | 35 x 35 | 19 | Wenge | ● |

designed by **CULTURE FORM**

Flaschenkühler „BRIDGE“
bottle cooler
champañera de buffet
seau à champagne

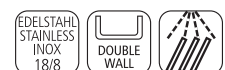

10 ltr.

doppelwandig für beste Isolierung, außen poliert, innen mattiert
Double wall cooler keeps the temperature for a long time, outside mirror polished, inside matt finish
Champañera inox de doble pared. Interior mate, exterior brillante
Seau inox double paroi, maintient le froid plus longtemps. Intérieur mat, extérieur poli brillant

| | □ cm | ↑ cm | ltr. |
|---------|------|------|------|
| 36077 8 | Ø 19 | 19 | 10 |

DESIGN IM DETAIL

Die reduzierte, archetypische Formsprache von FRAMES nimmt sich elegant zurück und lässt damit viel Raum für die Inszenierung der Buffet-Speisen. Ein scheinbarer Widerspruch löst sich auf: das Design ist zeitgemäß und zeitlos zugleich.

Design in detail – The classic minimalist visual style of FRAMES is elegantly understated, leaving plenty of potential for creating appealing buffet arrangements. Its design transcends what at first seems to be an irreconcilable paradox, being at once both timeless and highly contemporary.



„Neben formalen Aspekten ist eine sensible Auswahl von Materialien entscheidend, um ein erfolgreiches Design zu entwickeln.“

Michael Sieger / sieger design



Bildschön sind die Edelstahlplatten von FRAMES, die den Speisen des Buffets einen würdigen Rahmen verleihen sollen. **The attractive** FRAMES stainless steel platters provide buffet food with a setting that truly does it justice.



Das neue Buffetsystem, entwickelt von sieger design –
Funktionalität
Universalität
Stil

FRAMES

Die Grundidee von FRAMES ist einfach: köstlichen Speisen einen attraktiven Rahmen geben. Und das ist durchaus wörtlich zu verstehen. Wie hochwertige Rahmungen eines Bildes sind die Edelstahlplatten des Buffetsystems gestaltet. Gleichzeitig erfüllt FRAMES sämtliche Anforderungen des modernen gastronomischen Alltags. Die Funktionalität der Produkte war bei der Design-Entwicklung ein zentraler Gedanke.

The basic idea behind FRAMES is a simple one: framing delicious food in an attractive setting. It's a concept we've taken literally to create the stainless steel platters in our new buffet range, platters which work in the same way as high-quality picture frames. At the same time, FRAMES meets all the requirements of contemporary kitchens. Indeed, functionality was a core consideration throughout the design and development stages.

COOL PLATES

Sets

EDELSTAHL 18/10
stainless steel

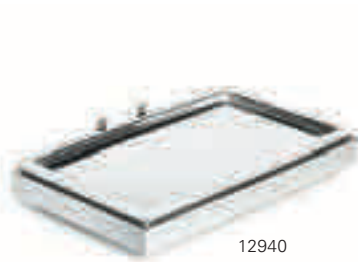

12940



12941

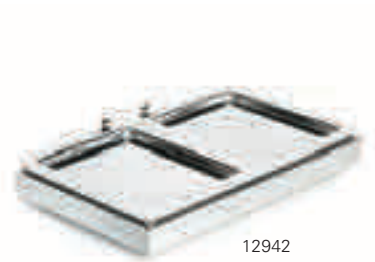

12942

WENGE
wenge



14940



14941



14942

AHORN
maple

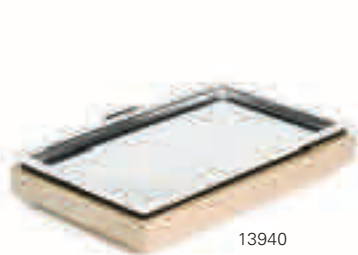

13940



13941

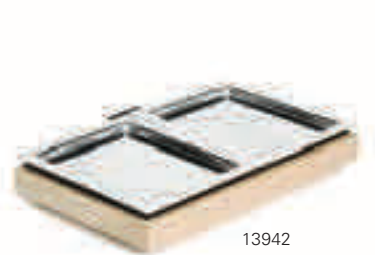

13942

SET 1

53 x 32,5 x 8,5 cm

GN 1/1 Basiselement
GN 1/1 Edelstahl Tablett 18/10
Kühlakku
GN 1/1 base element
GN 1/1 stainless steel platter 18/10

SET 2

53 x 32,5 x 27,5 cm

GN 1/1 Basiselement
GN 1/1 Edelstahl Tablett 18/10
Rolltop-Haube, Kühlakku
GN 1/1 base element
GN 1/1 stainless steel platter 18/10
rolltop cover, cooler

SET 3

53 x 32,5 x 8,5 cm

GN 1/1 Basiselement
2 x GN 1/2 Edelstahl Tablett 18/10
Kühlakku
GN 1/1 base element
2 x GN 1/2 stainless steel platters 18/10

Chop Modules



13955



13960



17910

CHOPPING BOARD 1

Ahorn, massiv
solid maple

GN 1/1

CHOPPING BOARD 2

Ahorn, massiv, gerillt
solid maple

GN 1/1

CHOPPING BOARD 3

Polyethylen, schwarz
Polyethylene, black

GN 1/1

COOL PLATES

Bowl Modules

WENGE
wenge



14950



14951



14952

AHORN
maple

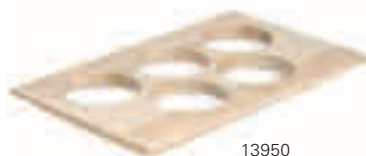

13950



13951



13952

BOWL MODULE

GN 1/1 Schüsselhalter einzeln
mit 5 Löchern, ø 13,2 cm
*GN 1/1 bowl module, each with
five holes, ø 13,2 cm*

BOWL MODULE SET 1

GN 1/1 Schüsselhalter Set
mit 5 weißen Melaminschüsseln
*GN 1/1 bowl module set with 5 white
melamine resin bowls*

BOWL MODULE SET 2

GN 1/1 Schüsselhalter Set mit
5 weißen Melaminschüsseln und
5 Deckeln
*GN 1/1 bowl module set with 5 white
melamine resin bowls and 5 lids*

Components

TRAYS

GN 1/1 Edelstahl Tablett 18/10
*GN 1/1 stainless steel platter
18/10*



11119

GN 1/2 Edelstahl Tablett 18/10
*GN 1/2 stainless steel platter
18/10*

11118

COVER

GN 1/1 Rolltop-Haube
rolltop cover



11018

Rolltop-Haube
für Basket Round
rolltop cover

Bowl L Deckel ø 23 cm *lid*
Bowl S Deckel ø 14,5 cm *lid*
– mit Dichtungsring für
luftdichtes Verschießen
– 2 fixierbare Öffnungs-
positionen einstellbar



10887

10890



18389

Kühlakku cooler

Polystyrolwanne GN 1/1, schwarz
polystyrene tray GN 1/1, black



10782

17922

BOWLS

Melaminschüssel weiß
melamine resin bowl white

ø 14 cm, Höhe 6,5 83700
ø 23 cm, Höhe 10 83702

Melaminschüssel schwarz
melamine resin bowl black

ø 14 cm, Höhe 6,5 83701
ø 23 cm, Höhe 10 83703

Edelstahlschüssel
stainless steel bowl

ø 14 cm, Höhe 6,5 30040
ø 23 cm, Höhe 10 30042

Glasschüssel

glass bowl
ø 14 cm, Höhe 6,5 11865
ø 23 cm, Höhe 10 11875



BOWL BOARDS

WENGE
wenge



AHORN
maple



Polystyrolwanne L schwarz
polystyrene tray L, black

17921

Polystyrolwanne S schwarz
polystyrene tray S, black

17920

BOWL BOARD L

SET 1 6-teilig 6 pcs.

Basiselement, Kunststoffwanne, Abdeckplatte für 3 Schüsseln (ø 23 cm), 3 Melaminschüsseln, weiß (79,5 x 26,5 x 8,5 cm)
base element, polystyrene tray L, cover panel to hold 3 bowls (ø 23 cm), 3 melamine resin bowls, white (79,5 x 26,5 x 8,5 cm)

BOWL BOARD L

SET 2 9-teilig 9 pcs.

Basiselement, Kunststoffwanne, Abdeckplatte für 3 Schüsseln (ø 23 cm), 3 Melaminschüsseln, weiß, mit Deckeln (79,5 x 26,5 x 8,5 cm)
base element, polystyrene tray L, cover panel to hold 3 bowls (ø 23 cm), 3 melamine resin bowls white, with lids (79,5 x 26,5 x 8,5 cm)

BOWL BOARD S

SET 1 6-teilig 6 pcs.

Basiselement, Kunststoffwanne, Abdeckplatte für 3 Schüsseln, Melaminschüsseln (ø 14 cm), weiß (53 x 17,6 x 8,5 cm)
base element, polystyrene tray S, cover panel to hold 3 bowls (ø 14 cm), 3 melamine resin bowls, white (53 x 17,6 x 8,5 cm)

BOWL BOARD S

SET 2 9-teilig 9 pcs.

Basiselement, Kunststoffwanne, Abdeckplatte für 3 Schüsseln (ø 14 cm), Melaminschüsseln, weiß, mit Deckeln (53 x 17,6 x 8,5 cm)
base element, polystyrene tray S, cover panel to hold 3 bowls (ø 14 cm), 3 melamine resin bowls, white, with lids (53 x 17,6 x 8,5 cm)

BOWL STANDS



11398



11399



11395



11396

11397

SET 1

Buffetleiter für 5 Schüsseln (ø 23 cm), Melaminschüsseln, weiß, mit Deckeln
bowl stand for 5 bowls (ø 23 cm), melamine

SET 2

Buffetleiter für 7 Schüsseln (ø 23 cm), Melaminschüsseln, weiß
bowl stand for 7 bowls (ø 23 cm),

Components

Leiter ladder 11395
Ring einzeln single 11396
Ring doppelt double 11397

BOWL BOXES

| | | | |
|--|--|--|---|
| <p>12925</p>  <p>12926</p> | <p>12920</p>  <p>12921</p> | <p>12915</p>  <p>12916</p> | <p>12910</p>  <p>12911</p> <p>EDELSTAHL 18/10 stainless steel</p> |
| <p>14925</p>  <p>14926</p> | <p>14920</p>  <p>14921</p> | <p>14915</p>  <p>14916</p> | <p>14910</p>  <p>14911</p> <p>WENGE wenge</p> |
| <p>13925</p>  <p>13926</p> | <p>13920</p>  <p>13921</p> | <p>13915</p>  <p>13916</p> | <p>13910</p>  <p>13911</p> <p>AHORN maple</p> |

BOWL BOX L

eckig *square*

Isolierendes Basiselement (26,5 x 26,5 cm, Höhe 8,5 cm) mit Melaminschüsseln, weiß, mit oder ohne Deckel
Insulating base element (26,5 x 26,5 cm, height 8,5 cm) with melamine resin

BOWL BOX S

eckig *square*

Isolierendes Basiselement (17,4 x 17,4 cm, Höhe 6 cm) mit Melaminschüsseln, weiß, mit oder ohne Deckel
Insulating base element (17,4 x 17,4 cm, height 6 cm) with melamine resin

BOWL BOX L

rund *round*

Isolierendes Basiselement (ø 26,5 cm, Höhe 8,5 cm) mit Melaminschüssel, weiß, mit oder ohne Deckel
Insulating base element (ø 26,5 cm, height 8,5 cm) with melamine resin

BOWL BOX S

rund *round*

Isolierendes Basiselement (ø 17,4 cm, Höhe 6 cm) mit Melaminschüssel, weiß, mit oder ohne Deckel
Insulating base element (ø 17,4 cm, height 6 cm) with melamine resin

BASKETS

| | | |
|---|--|---|
| <p>40293</p>  <p>GN 1/1</p> <p>40291</p> | <p>40292</p>  <p>GN 1/2</p> <p>40290</p> | <p>40295</p>  |
| <p>40294</p>  | <p>BASKET L</p> <p>Polyrattan, dunkelbraun <i>Polyrattan, dark brown</i></p> <p>GN 1/1, 53 x 32,5 x 10 cm GN 1/1, 53 x 32,5 x 6,5 cm</p> <p>56,5 x 36 x 10 cm mit Haubenschiene (ohne Haube 11018) <i>with frame to fix the cover</i></p> | <p>BASKET S</p> <p>Polyrattan, dunkelbraun <i>Polyrattan, dark brown</i></p> <p>GN 1/2, 32,5 x 26,5 x 10 cm GN 1/2, 32,5 x 26,5 x 6,5 cm</p> <p>BASKET ROUND</p> <p>Polyrattan, dunkelbraun, <i>Polyrattan, dark brown</i></p> <p>ø 40 cm, Höhe <i>height</i> 12,5 cm mit Haubenschiene (ohne Haube 18389) <i>with frame to fix the cover</i> (without cover 18389)</p> |

designed by **sieger design**

GN 1/1 - 1/2 - 1/3



Tablett „FRAMES“
tray
bandeja
plat



| | cm | ↑ cm | GN | |
|---------|-------------|------|-----|---|
| 84046 1 | 53,0 x 32,5 | 2 | 1/1 | ○ |
| 84047 8 | 32,5 x 26,5 | 2 | 1/2 | ○ |
| 84048 5 | 32,5 x 17,5 | 2 | 1/3 | ○ |

2-teilig / 2 pcs.



14956

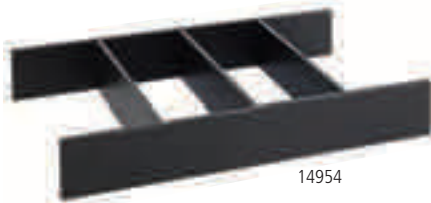

14954

Besteck- / Universal-Box, 2-teilig „FRAMES“
cutlery tray, 2 pcs.
cuberto o cajón multi-usos, 2pz.
caisson à couverts ou multi-usages



Buche massiv, Wenge, 4 Fächer, inklusive herausnehmbaren Einsatz
wood wenge, 4 compartments
Madera de haya maciza, color wengué, 4 compartimentos, separadores removibles
Hêtre massif, couleur wengué, 4 compartiments, séparateurs amovibles

| | cm | ↑ cm |
|---------|-----------|------|
| 14956 4 | 53 x 32,5 | 11 |

Einzelteile / spare parts / piezas sueltas / pièces détachées

Einsatz für GN1/1 „FRAMES“ / insert for GN1/1 „FRAMES“
interior para GN1/1 „FRAMES“ / insert pour GN1/1 „FRAMES“

| | | |
|---------|-----------|---|
| 14954 0 | 48,5 x 28 | 8 |
|---------|-----------|---|

Eisbox „FRAMES“
ice box
bandeja hielo para el buffet
caisse à glacons pour le buffet



3-teilig: 1 Basiselement Wenge + 1 Polystyrolwanne + 1 Tropfgitter
3 pcs. set: 1 box wenge + 1 plastic deep tray + 1 st. steel drainer plate
Set 3 piezas : 1 cajón color Wengué, 1 cubeta plástico, 1 rejilla inox
Set 3 éléments: caisson couleur Wengué, 1 bac plastique, 1 plaque perforée inox

| | cm | ↑ cm | GN |
|---------|-----------|------|-----|
| 14970 0 | 53 x 32,5 | 12,5 | 1/1 |

Gestell für GN1/1 „FRAMES“
serving stand
cuberto o cajón multi-usos
caisson à couverts ou multi-usages



Buche massiv, Wenge
wood, wenge
madera de haya maciza, color wengué
hêtre massif, couleur wengué

| | cm | ↑ cm |
|---------|-------------|------|
| 14953 3 | 57,5 x 27,5 | 22 |

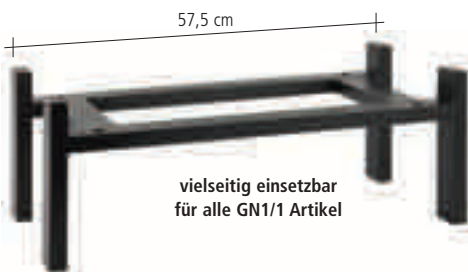

vielseitig einsetzbar
für alle GN1/1 Artikel



84047
GN 1/2

84047
GN 1/2

14942
passendes GN 1/1 Basiselement

Cool Plate + Haube
12941



Gestell GN1/1
14953



Gestell GN1/1
14953

Besteck / Universal-Box
GN1/1 - 14956

Buffetgestell „TRIANGLE“
buffet stand
expositor de bufet
présentoir à céréales



| | □ cm | ↑ cm | | |
|---------|---------|------|---|---------------|
| 13966 4 | 53 x 21 | 50 | ● | Ahorn / maple |
| 14966 3 | 53 x 21 | 50 | ● | Wenge / wenge |



13966



14966

30 x 15 cm

40 x 17,5 cm

53 x 19 cm

Buffet-Tower
Buffet-Tower
torre para bufet
tour carrée pour le buffet



3-stufig, Glas in Spiegeloptik, Holz Birke dunkelbraun, Lieferung demontiert
with beech wood pillar, tempered glass mirror surface, each in knock-down packing
3 pisos , vidrio templado, eje central de madera oscura. Se entrega desmontado
3 étages, verre trempé, axe central carré en bois foncé. Livré non-monté

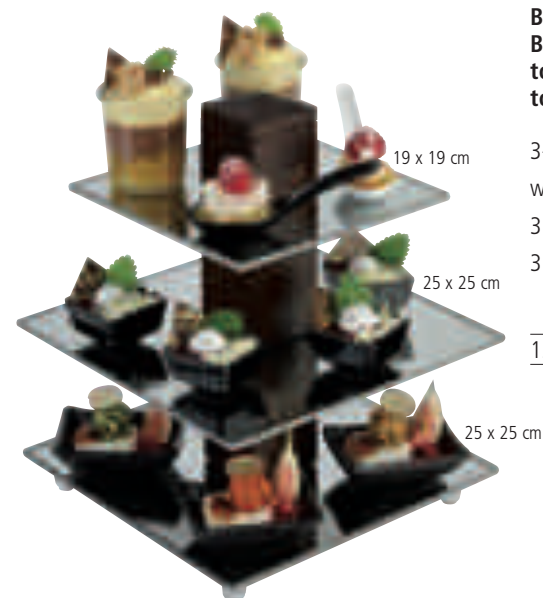

19 x 19 cm

25 x 25 cm

25 x 25 cm

| | □ cm | ↑ cm |
|---------|---------|------|
| 12415 8 | 25 x 25 | 30,5 |

High Tea Rack
High Tea Rack
rack de te alto
étagère à thé avec anse supérieure



Holz dunkelbraun, Edelstahlgriff, 4 große Fächer 15 x 10 x 10 cm,
3 kleine Fächer 9,5 x 9,5 x 10 cm

rubber wood in dark brown, stainless handle

madera marrón oscuro, mango de acero inoxidable.

bois marron foncé, poignée inox



| | □ cm | ↑ cm |
|---------|---------|------|
| 33210 2 | 34 x 10 | 38 |

BUFFET-STÄNDER designed by CULTURE FORM



Buffet-Ständer „STAR“
buffet stand
soporte para buffet
présentoire buffet



Metall, mit schwarzer Antirutschgummierung
metal, with black anti-slide coating
acero cromado, con recubrimiento negro antideslizante
metal avec revêtement plastique noir anti-glisse

| | ↑ cm |
|---------|------|
| 33260 7 | 8 |
| 33261 4 | 12 |
| 33262 1 | 18 |



designed by **CULTURE FORM**



↑ 14 cm
03622



↑ 21 cm
03623

Buffet-Ständer „KING“
buffet stand
soporte para bufet
présentoir buffet



kein Verrutschen, Arme und Boden sind mit Antirutschflächen ausgestattet, schwere standsichere Qualität, Fuß dient als Löffelablage

the arms and base are equipped with non-slip surfaces, stable quality, base serves as spoon holder

anti-deslizante: revestimiento antideslizante en las puntas de los brazos y en la base. Estable y alta calidad. la base sirve como reposacuchara

anti-glisse: revêtement anti-dérapant sur les extrémités des 3 pieds et sur la base. Robuste, stable et bonne qualité. La base sert de support pour les couverts

| | ☐ cm | ↑ cm |
|---------|------|------|
| 03622 2 | ∅ 15 | 14 |
| 03623 9 | ∅ 15 | 21 |

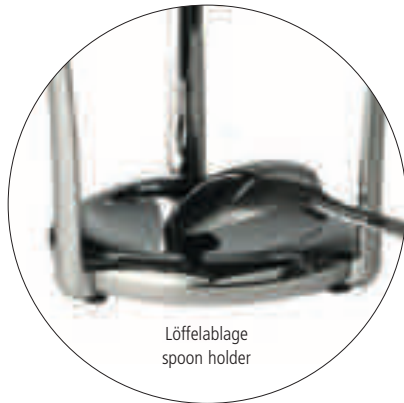
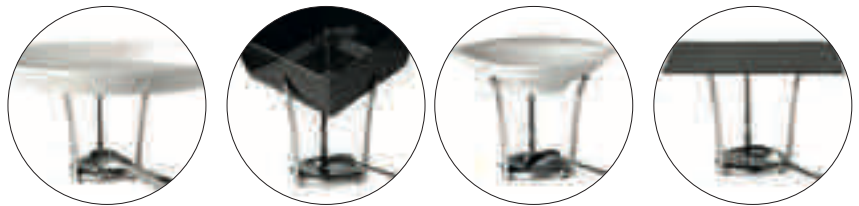

Löffelablage
spoon holder

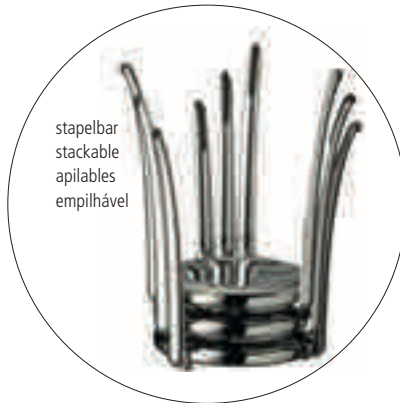

stapelbar
stackable
apilables
empilhável



rutschfeste Oberfläche
non-slip surface
superficie antideslizante
acabamento não deslizante

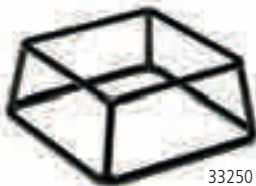

33250

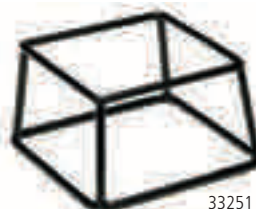

33251

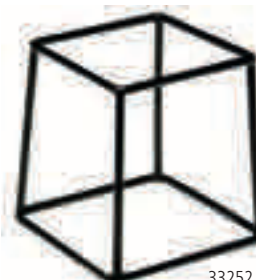

33252

Buffet-Ständer „MULTI“
buffet stand
soporte para bufet
présentoir buffet



Metall, mit schwarzer Antirutschgummierung ummantelt

metal, with black anti-slide coating

acero cromado, con recubrimiento negro antideslizante

metal avec revêtement plastique noir anti-glisse

| | ☐ cm | ↑ cm |
|---------|---------|------|
| 33250 8 | 18 x 18 | 8 |
| 33251 5 | 18 x 18 | 10 |
| 33252 2 | 18 x 18 | 18 |



für jede Art von
Platten, Tablets und
Schalen geeignet

Buffet-Gestell
buffet stand
soporte para buffet
Présentoir buffet

3-stufig, geeignet für runde und rechteckige Körbe, platzsparend zusammenklappbar, Lieferung ohne Körbe

3-tier, usable for round and rectangular baskets, can be bushed together for place saving, delivery without baskets

3 alturas, apto para cestas redondas y rectangulares, se puede plegar para ahorrar espacio, se entrega sin cestas.

3 hauteurs, pour corbeilles rondes ou rectang.. La structure s'ouvre ou se ferme pour réduire l'encombrement. Livré sans corbeilles.

| | ☐ cm | ↑ cm |
|---------|-----------|------|
| 33232 4 | 59 x 30,5 | 59 |

Einzelteile / spare parts / piezas sueltas / pièces détachées

Tisch- und Buffetkorb, rund „ECONOMIC“ / buffet basket, round
cesta de bufet redonda / corbeille à pain ronde

| | | | | |
|---------|--------|------|---|----------------|
| 40144 0 | Ø 39,0 | 10,0 |  | natur / nature |
|---------|--------|------|---|----------------|

Buffet-Korb GN System / buffet basket GN system
cestas de bufet sistema GN / corbeilles de buffet système GN

| | | | | |
|---------|-----------|----|---|----------------|
| 40240 9 | 53 x 32,5 | 10 |  | natur / nature |
| 40270 6 | 53 x 32,5 | 10 |  | braun / brown |

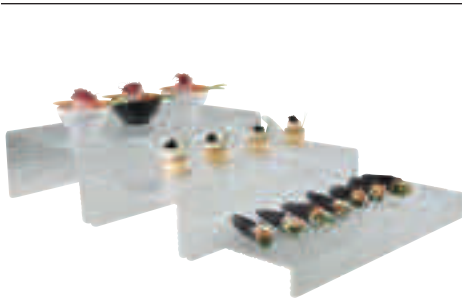

03617
3-teiliges Set



03621
3-teiliges Set

Stufen-Display
tier display
expositor en escalera
présentoir en escalier

mit Schieferstruktur

with slate structure

con relieve tipo pizarra

avec relief irrégulier type ardoise

| | ☐ cm | ↑ cm |
|---------|---------|------|
| 03614 7 | 40 x 18 | 4 |
| 03615 4 | 40 x 20 | 8 |
| 03616 1 | 40 x 22 | 12 |

| | | |
|---------|---------|----|
| 03618 5 | 20 x 18 | 4 |
| 03619 2 | 20 x 20 | 8 |
| 03620 8 | 20 x 22 | 12 |

3-teiliges Set: 03614 + 03615 + 03616

3 pcs. set: 03614 + 03615 + 03616

set de 3 piezas: 03614 + 03615 + 03616

set 3 pièces: 03614 + 03615 + 03616

| |
|---------|
| 03617 8 |
|---------|

3-teiliges Set: 03618 + 03619 + 03620

3 pcs. set: 03618 + 03619 + 03620

set de 3 piezas: 03618 + 03619 + 03620

set 3 pièces: 03618 + 03619 + 03620

| |
|---------|
| 03621 5 |
|---------|



Displaysäule mit Deckel
riser with cover
display con tapa
présentoir avec couvercle



| | □ cm | ↑ cm |
|---------|------|------|
| 33265 2 | Ø 20 | 10 |
| 33266 9 | Ø 20 | 20 |
| 33267 6 | Ø 20 | 30 |

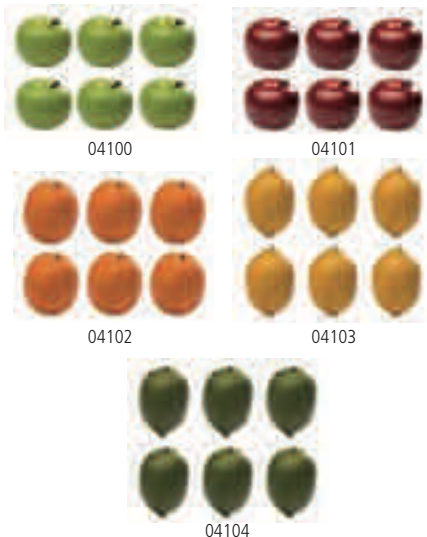

Dekorations Lebensmittel Replika
imitation replica fruits
imitaciones de alimentos Replica
imitations d'aliments Réplika



6er Set, ideal verwendbar für das Buffet, nur für Dekorationszwecke einsetzbar
 6 pcs. set
 set de 6 piezas
 set de 6 pièces

| | □ cm | ↑ cm | |
|---------|-------|------|--------------------------|
| 04100 4 | Ø 8 | 7 | Apfel grün / apple green |
| 04101 1 | Ø 7,5 | 6,5 | Apfel rot / apple red |
| 04102 8 | Ø 8 | 9 | Orange / orange |
| 04103 5 | Ø 7 | 10 | Zitrone / lemon |
| 04104 2 | Ø 6 | 8 | Limette / lime |



Etagère „ROYAL“
etagère
estante
présentoir



5-teilig: 3 Edelstahl-Schalen + 2 Gestelle, einfach übereinanderstellen, einzeln nutzbar
 5 pcs. set: 3 bowls + 2 frames, easy to assemble, single usable
 set de 5 piezas: 3 bols, 2 soportes, fácil de montar
 5 éléments: 3 bols et 2 supports. Montage facile

| | □ cm | ↑ cm | ltr. |
|---------|----------------|------|------|
| 24336 1 | Ø 24 / 33 / 42 | 43,5 | |

3-teilig: 2 Edelstahl-Schalen + 1 Gestelle, einfach übereinanderstellen, einzeln nutzbar
 3 pcs. set: 2 bowls + 1 frame, easy to assemble, single usable
 set de 3 piezas: 2 bols, 1 soporte, fácil de montar
 3 éléments: 2 bols et 1 support. Montage facile

| | | | |
|---------|-----------|----|--|
| 24335 4 | Ø 33 / 42 | 25 | |
| 24334 7 | Ø 24 / 33 | 22 | |

Einzelteile / spare parts / piezas sueltas / pièces détachées

Schale, innen hochglanzpoliert, außen matt poliert
 bowl, mirror polished finish inside, satin polished finish outside
 fuente, pulido espejo en el interior, exterior mate
 plateau intérieur effet brillant, extérieur mat

| | □ cm | ↑ cm | ltr. |
|---------|------|------|------|
| 24330 9 | Ø 24 | 3 | 0,6 |
| 24331 6 | Ø 33 | 4 | 1,3 |
| 24332 3 | Ø 42 | 5 | 2,5 |

Gestell einzeln / stand alone / pie soporte / pied seul

| | | | |
|---------|------|----|--|
| 24338 5 | Ø 18 | 19 | |
| 24339 2 | Ø 24 | 20 | |



33240
LARGE

Etagère „FRUITS BUFFET“
etagère
frutero
présentoir à fruits



hochglanzpoliert, Edelstahl-Schale herausnehmbar
 mirror polished finish, bowl removable
 acabado brillante, bandeja inferior suelta
 effet brillant, bol inférieur amovible

| | ☐ cm | ↑ cm |
|---------|--------|------|
| 33235 5 | Ø 27,5 | 32 |
| 33240 9 | Ø 32 | 53 |

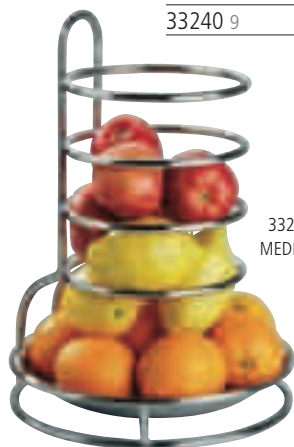

33235
MEDIUM

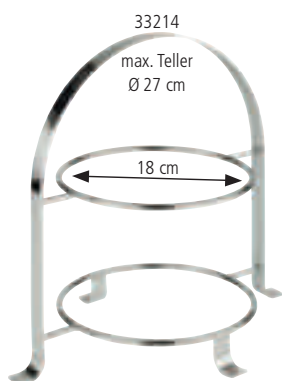

33214
max. Teller
Ø 27 cm

18 cm

Serviergestell Metallprofil flach
serving stand flat profile
soporte con perfil acero cromado plano
présentoir, profil métal plat



für 2 Teller max. Ø 27 cm, innerer Ring Ø 18 cm, Lieferung ohne Teller
 for 2 plates max. Ø 27 cm, circle inside Ø 18 cm, without dishes
 para 2 platos Ø 27 cm, interior aro Ø 18 cm. Se entrega sin platos
 pour 2 assiettes maxi Ø 27 cm, cercle Ø int. 18 cm, livré sans assiettes

| | ☐ cm | ↑ cm |
|---------|-----------|------|
| 33214 0 | 33 x 23,5 | 30 |



33216
max. Teller
Ø 17 cm

für 3 Teller max. Ø 17 cm, innerer Ring Ø 10,5 cm
 for 3 plates max. Ø 17 cm, circle inside Ø 10,5 cm
 para 3 platos Ø 17 cm, interior aro Ø 10,5 cm
 pour 3 assiettes maxi Ø 17 cm, cercle Ø int. 10,5 cm

| | ☐ cm | ↑ cm |
|---------|-------------|------|
| 33216 4 | 22,5 x 16,5 | 25,5 |



33217
max. Teller
Ø 27 cm

für 3 Teller max. Ø 27 cm, innerer Ring Ø 18 cm
 for 3 plates max. Ø 27 cm, circle inside Ø 18 cm
 para 3 platos Ø 27 cm, interior aro Ø 18 cm
 pour 3 assiettes maxi Ø 27 cm, cercle Ø int. 18 cm

| | | |
|---------|---------|----|
| 33217 1 | 33 x 24 | 43 |
|---------|---------|----|

NEW

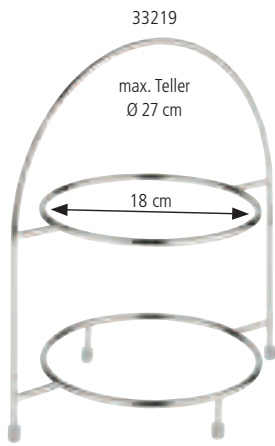

Serviergestell Metallprofil rund
serving stand wire
soporte platos, alambre metálico
présentoir à assiettes en tube métallique



für 2 Teller max. Ø 27 cm, innerer Ring Ø 18 cm
 for 2 plates max. Ø 27 cm, circle inside Ø 18 cm
 para 2 platos Ø 27 cm, interior aro Ø 18 cm
 pour 2 assiettes maxi Ø 27 cm, cercle Ø int. 18 cm

| | ☐ cm | ↑ cm | |
|---------|-----------|------|----------|
| 33219 5 | 29 x 19,5 | 30 | ● chrome |



für 3 Teller max. Ø 17 cm, innerer Ring Ø 10,5 cm
 for 3 plates max. Ø 17 cm, circle inside Ø 10,5 cm
 para 3 platos Ø 17 cm, interior aro Ø 10,5 cm
 pour 3 assiettes maxi Ø 17 cm, cercle Ø int. 10,5 cm

| | ☐ cm | ↑ cm | |
|---------|-------------|------|----------|
| 33215 7 | 18,5 x 15,5 | 26 | ● chrome |
| 33211 9 | 18,5 x 15,5 | 26 | ● copper |

für 3 Teller max. Ø 27 cm, innerer Ring Ø 18 cm
 for 3 plates max. Ø 27 cm, circle inside Ø 18 cm
 para 3 platos Ø 27 cm, interior aro Ø 18 cm
 pour 3 assiettes maxi Ø 27 cm, cercle Ø int. 18 cm

| | | | |
|---------|-----------|----|----------|
| 33220 1 | 29 x 19,5 | 43 | ● chrome |
| 33212 6 | 29 x 19,5 | 43 | ● copper |

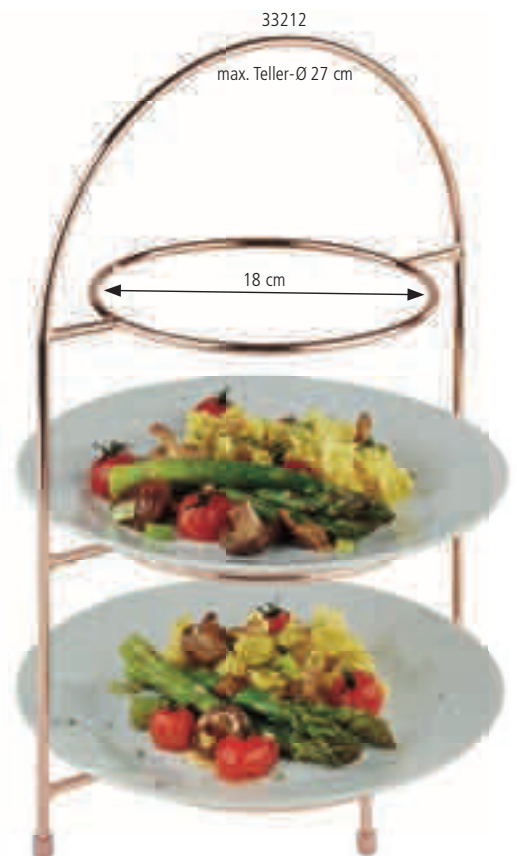

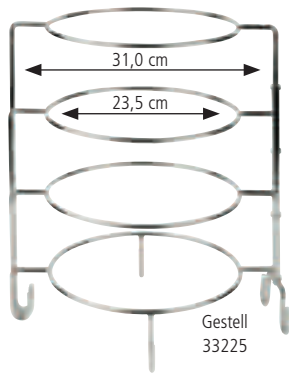

Serviergestell
serving stand
soporte platos
présentoir à assiettes



für 4 Teller (max. Ø 31 cm), platzsparend zusammendrehbar, Lieferung ohne Teller
 for 4 plates (max. Ø 31 cm), can be pushed together for place saving, without dishes
 para 4 platos (max. Ø 31 cm) se puede plegar para ahorrar espacio, se sirve sin platos
 pour 4 assiettes maxi 31 cm. Peut se refermer pour réduire l'encombrement. Livré sans assiettes

| | ☐ cm | ↑ cm |
|---------|------|------|
| 33225 6 | Ø 34 | 37 |



viele Möglichkeiten
 die Speisen
 zu präsentieren



Serviergestell
serving stand
expositor
présentoir



3-stufig für quadratische Teller / Platten in 3 verschiedenen Größen: z.B. 83407 + 83406 + 83405, Lieferung ohne Teller/Platten

3-tier for square dishes / plates in 3 different sizes: e.g. 83407 + 83406 + 83405, delivery without dishes / plates

3 alturas para platos cuadrados platos/fuentes en 3 diferentes medidas ej, 83407+83406+83405 se entrega sin platos/ fuentes

3 niveaux pour assiettes ou plats carrés de différentes dimensions, ex. 83407 / 83406 / 83405, livré sans assiettes

| | ☐ cm | ↑ cm |
|---------|-------------|------|
| 33231 7 | 37,5 x 37,5 | 50 |



Tablett „PURE“

tray

bandeja

plateau

| | | |
|---------|-------------|---|
| 83407 1 | 21,0 x 21,0 | 3 |
| 83406 4 | 26,5 x 26,5 | 3 |
| 83405 7 | 37,0 x 37,0 | 3 |

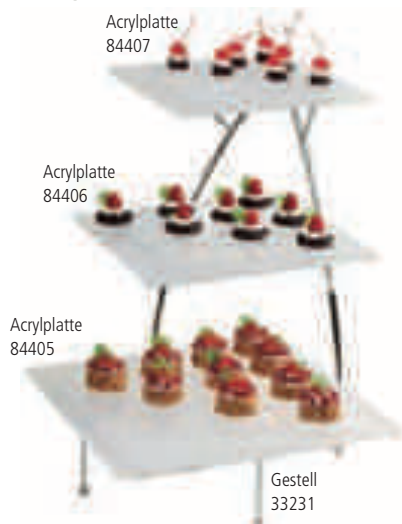

Acrylplatte

plate acryl

bandeja de metacrilato

plateau acrylique

| | |
|---------|-------------|
| 84407 0 | 23 x 23 |
| 84406 3 | 30,5 x 30,5 |
| 84405 6 | 38 x 38 |

Etagère „CASUAL“
etagère
expositor de bombones o bocaditos
présentoir à mignardises



inkl. Schild
 incl. sign
 incluida la inscripción
 avec inscription

| | □ cm | ↑ cm | |
|---------|----------------|------|---|
| 34248 4 | Ø 31 - 41 - 51 | 55 | 3-stufig / 3-tier 3 niveles / 3 étages |
| 34247 7 | Ø 31 - 41 | 35 | 2-stufig / 2-tier 2 niveles / 2 étages |



einsteckbares Edstahlschild,
 beschriftbar (Schild ist nicht beschriftet)



Etagère „FINESSE“
etagère
frutero
étagère



vergoldeter Messing-Kugelgriff, einfache Montage
 gold plated knob, easy to assemble
 botón dorado, fácil de montar
 bouton doré, montage facile

| | □ cm | ↑ cm |
|---------|----------------|------|
| 33238 6 | Ø 38 / 32 | 30 |
| 33248 5 | Ø 48 / 38 / 32 | 50 |





**Etagère
etagère
expositor
présentoir à petits fours**



hochglanzpoliert, einfache Montage
mirror polished finish, easy to assemble
acabado efecto espejo, fácil de montar
effet brillant, montage facile

| | ☐ cm | ↑ cm | |
|---------|-------------|------|--|
| 00195 4 | Ø 15 / 10,5 | 22 | |



**Etagère
etagère
expositor
présentoir à petits fours**



| | ☐ cm | ↑ cm | |
|---------|-----------|------|--|
| 00193 0 | Ø 14 / 11 | 16 | |



vielseitig
einsetzbar
für Küche
und Buffet

**Etagère
etagère
frutero
corbeille à fruits**



ergonomischer Griff, stehend auf schwarzen Antirutsch-Füßen
ergonomic handle, anti-slip-feet
asa ergonómica, pies antideslizantes color negro
anse ergonomique, pieds anti-dérapants noirs

| | ☐ cm | ↑ cm | |
|---------|---------|------|--|
| 30325 6 | 30 x 30 | 35,5 | |



**2-stufige Etagère
2 tier tray
bandeja dos alturas
plat carré 2 hauteurs**



| | ☐ cm | ↑ cm | * mm |
|---------|-----------|------|-------|
| 00989 9 | Ø 25 / 20 | 24 | 4 - 7 |



Brezel- oder Wurstständer
pretzel-/ sausage stand
soporte para embutidos
support à bretzel ou saucissons



matt poliert
 satin polished finish
 acabado pulido satinado
 poli satiné

| | ☐ cm | ↑ cm |
|---------|------|------|
| 79554 9 | Ø 21 | 50 |



Brezel- oder Wurstständer
pretzel-/ sausage stand
soporte para embutidos
présentoir à bretzels ou à saucissons



Verkaufsständer Buchen-Holz versiegelt, bestens geeignet für die Präsentation von Brezeln, Würstchen, etc., Fuß Ø 22 cm
 beech wood, ideal to present pretzels, sausages, etc.
 madera de haya, ideal para presentar fiambres, salchichones etc.
 en hêtre, idéal pour bretzels ou saucissons, etc

| | ☐ cm | ↑ cm |
|---------|------|------|
| 79553 2 | Ø 28 | 50 |

inkl.
 Frischhaltehaube



macht das Schaben von
 hauchdünnen Röschen
 zum Kinderspiel



Hobel für Käse und Schokolade
cheese / choco curler
rizador para queso y chocolate
frisette pour fromage et chocolat



3-teilig: Platte Buchen-Holz versiegelt Ø 22 cm mit senkrechtem Stift + Hobel 7 cm + Haube Ø 15 x 10 cm, für Käse und Schokolade

3 pcs. set: wooden base Ø 22 cm with vertical bolt + plough 7 cm + cover Ø 15 x 10 cm, for cheese and choco

set de 3 piezas: base de madera Ø 22 cm, con eje vertical de 7cm+ campana Ø 15 x 10 cm, para „rizar“ queso y chocolate

Set 3 pièces pour „friser“ le fromage ou le chocolat: base bois Ø 22 cm, axe vertical ht. 7 cm, cloche Ø 15 x Ht 10 cm

| | ☐ cm | ↑ cm |
|---------|------|------|
| 50002 0 | Ø 22 | 15 |

BUFFET-LEITER „GN“ NEW



„LITTLE GN“

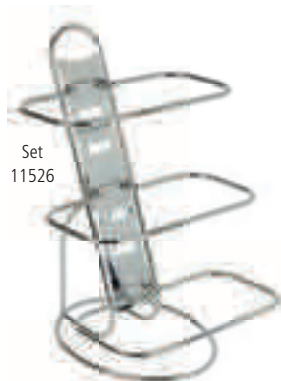

Buffet-Leiter „LITTLE GN 1/3“
buffet ladder
dispensador en escalera
présentoir buffet en escalier



4-teilig: 1 Leiter-Gestell, 3 GN 1/3 Rahmen
 4 pcs.: 1 ladder, 3 single rings GN 1/3
 4 pz: 1 soporte escalera, 3 aros sencillos GN 1/3
 4 pc: 1 support escalier, 3 cercles simples GN 1/3

| | cm | cm | matches |
|---------|-----------|----|---------------------|
| 11526 2 | 31,5 x 32 | 48 | baskets/pans GN 1/3 |

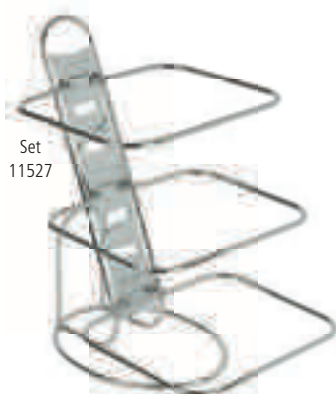

Buffet-Leiter „LITTLE GN 1/2“
buffet ladder
dispensador en escalera
présentoir buffet en escalier



4-teilig: 1 Leiter-Gestell, 3 GN 1/2 Rahmen
 4 pcs.: 1 ladder, 3 single rings GN 1/2
 4 pz: 1 soporte escalera, 3 aros sencillos GN 1/2
 4 pc: 1 support escalier, 3 cercles simples GN 1/2

| | cm | cm | matches |
|---------|-------------|----|---------------------|
| 11527 9 | 31,5 x 41,5 | 48 | baskets/pans GN 1/2 |

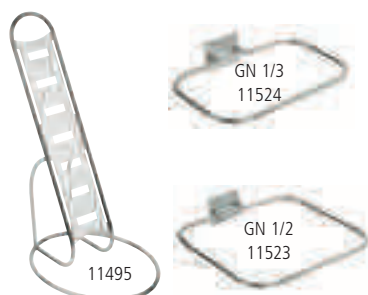

Einzelteile / spare parts / piezas sueltas / pièces détachées

Leiter-Gestell / frame / estructura en escalera / support en escalier

11495 1

Einzelring GN 1/3 / single ring GN 1/3 / aro sencillo GN 1/3 / cercle simple GN 1/3

11524 8

Einzelring GN 1/2 / single ring GN 1/2 / aro sencillo GN 1/2 / cercle simple GN 1/2

11523 1



„BIG GN“



Set
11528

Buffet-Leiter „BIG GN 1/2“ buffet ladder dispensador en escalera présentoir buffet en escalier



- 5-teilig: 1 Leiter-Gestell, 4 GN 1/2 Rahmen
5 pcs.: 1 ladder, 4 single rings GN 1/2
5 pz: 1 soporte escalera, 4 aros sencillos GN 1/2
5 pc: 1 support escalier, 4 cercles simples GN 1/2

| | ☐ cm | ↑ cm | matches |
|---------|-----------|------|---------------------|
| 11528 6 | 31,5 x 56 | 66 | baskets/pans GN 1/2 |

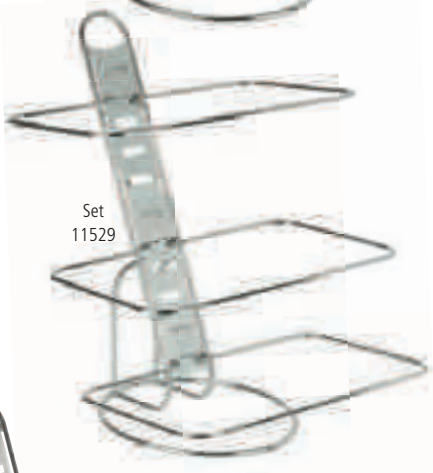

Set
11529

Buffet-Leiter „BIG GN 1/1“ buffet ladder dispensador en escalera présentoir buffet en escalier



- 4-teilig: 1 Leiter-Gestell, 3 GN 1/1 Rahmen
4 pcs.: 1 ladder, 3 single rings GN 1/1
4 pz: 1 soporte escalera, 3 aros sencillos GN 1/1
4 pc: 1 support escalier, 3 cercles simples GN 1/1

| | ☐ cm | ↑ cm | matches |
|---------|---------|------|---------------------|
| 11529 3 | 52 x 59 | 66 | baskets/pans GN 1/1 |



11595



GN 1/2
11523



GN 1/1
11522

Einzelteile / spare parts / piezas sueltas / pièces détachées

Leiter-Gestell / frame / estructura en escalera / support en escalier

11595 8

Einzelring GN 1/2 / single ring GN 1/2 / aro sencillo GN 1/2 / cercle simple GN 1/2

11523 1

Einzelring GN 1/1 / single ring GN 1/1 / aro sencillo GN 1/1 / cercle simple GN 1/1

11522 4



12-teiliges Set
11598

jede Schale
ca. 2,5 Liter Inhalt



11-teiliges Set
11599

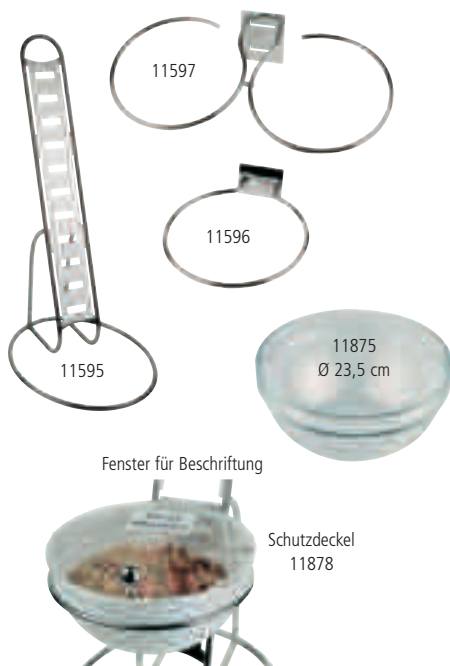

Fenster für Beschriftung

Schutzdeckel
11878

Buffet-Leiter „BIG“
buffet ladder
dispensador en escalera
Présentoir buffet en escalier



12-teiliges Set: 4 Glasschalen Ø 23 cm 2,5 Liter, 4 klappbare Schutzdeckel mit Beschriftungsfenster, 1 Leiter, 1 Doppelring, 2 Einzelringe, einfach und individuell zusammensetzbar

12 pcs. set: 4 glass bowls Ø 23 cm 2.5 litres, 4 hinged covers with card for inscription, 1 ladder, 1 double ring, 2 single rings, easy to fix and individual to use

set 12 pz: 4 bols vidrio Ø 23 cm 2.5 L, 4 tapas abatibles con ventana para etiqueta, 1 soporte escalera, 1 aro doble, 2 aros sencillos, fácil de montar, posible usar individualmente

12 éléments: 4 bols verre Ø 23 cm 2.5 L, 4 couvercles à charnière et fenêtre p/ étiquette, 1 support escalier, 1 cercle double, 2 cercles simples, montage facile, utilisable individuellement

| | ☐ cm | ↑ cm |
|---------|---------|------|
| 11598 9 | 39 x 31 | 66 |

11-teiliges Set: 6 Glasschalen Ø 23 cm 2,5 Liter, 1 Leiter, 2 Doppelringe, 2 Einzelringe, einfach und individuell zusammensetzbar

11 pcs. set: 6 glass bowls Ø 23 cm 2.5 litres, 1 ladder, 2 double rings, 2 single rings, easy and individual to use

set 11 pz: 6 bols vidrio Ø 23 cm 2.5 L, 1 soporte escalera, 2 aros dobles, 2 aros sencillos, fácil montar, se puede usar individualmente

11 éléments: 6 bols verre Ø 23 cm 2.5 L, 1 support escalier, 2 cercle double, 2 cercles simples, montage facile, utilisable individuellement

| | | |
|---------|---------|----|
| 11599 6 | 39 x 31 | 66 |
|---------|---------|----|

Einzelteile / spare parts / piezas sueltas / pièces détachées

Leiter-Gestell / frame / estructura en escalera / support en escalier

11595 8

Einzelring / single ring / aro sencillo / cercle simple

11596 5

Doppelring / double ring / aro doble / cercle double

11597 2

Schale / bowl / bol / bol

11875 1 Ø 23 10,5

Schutzdeckel, mit vergoldetem Griff / cover, gold plated handle
tapa, botón dorado / couvercle, bouton doré

11877 5 Ø 23,5

Schutzdeckel, mit verchromtem Griff / cover, chrome plated handle
tapa, botón cromado / couvercle, bouton chromé

11878 2 Ø 23,5



Buffet-Leiter „LITTLE“
buffet ladder
dispensador en escalera
Présentoir buffet en escalier

jede Schale
 ca. 0,5 Liter Inhalt

12-teiliges Set
 11498



12-teiliges Set: 4 Glasschalen Ø 14 cm 0,5 Liter, 4 klappbare Schutzdeckel mit Beschriftungsfenster, 1 Leiter, 1 Doppelring, 2 Einzelringe, einfach und individuell zusammensetzbar

12 pcs. set: 4 glass bowls Ø 14 cm 0.5 litres, 4 hinged covers with card for inscription, 1 ladder, 1 double ring, 2 single rings, easy and individual to use

set de 12 pz: 4 bols verre Ø 14 cm 0.5 L, 4 tapas abatibles con ventana para etiqueta, 1 soporte escalera, 1 aro doble, 2 aros sencillos, fácil montaje, se puede usar individualmente

12 éléments: 4 bols verre Ø 14 cm 0.5 L, 4 couvercles à charnière et fenêtre p/ étiquette, 1 support escalier, 1 cercle double, 2 cercles simples, montage facile, utilisable individuellement

| | □ cm | ↑ cm |
|---------|---------|------|
| 11498 2 | 30 x 30 | 48 |

11-teiliges Set
 11499



11-teiliges Set: 6 Glasschalen Ø 14 cm 0,5 Liter, 1 Leiter, 2 Doppelringe, 2 Einzelringe, einfach und individuell zusammensetzbar

11 pcs. set: 6 glass bowls Ø 14 cm 0.5 litres, 1 ladder, 2 double rings, 2 single rings, easy and individual to use

set de 11 pz: 6 bols verre Ø 14 cm 0.5 L, 1 soporte escalera, 2 aros dobles, 2 aros sencillos, fácil montaje, se puede usar individualmente

11 éléments: 6 bols verre Ø 14 cm 0.5 L, 1 support escalier, 1 cercle double, 2 cercles simples, montage facile, utilisable individuellement

| | | |
|---------|---------|----|
| 11499 9 | 30 x 30 | 48 |
|---------|---------|----|

Einzelteile / spare parts / piezas sueltas / pièces détachées

Leiter-Gestell / frame / marco solo en escalera / échelle support

11495 1

Einzelring / single ring / aro sencillo / cercle simple

11496 8

Doppelring / double ring / aro sencillo / cercle double

11497 5

Schale / bowl / bol / bol

11865 2 Ø 14

Schutzdeckel, mit vergoldetem Griff / cover, gold plated handle
 tapa, botón dorado / couvercle, bouton doré

11867 6 Ø 14,5

Schutzdeckel, mit verchromtem Griff / cover, chrome plated handle
 tapa, botón cromado / couvercle, bouton chromé

11868 3 Ø 14,5





11220
GN1/1

Tablett „SUNDAY“
tray with wide inclined rim
bandeja bordes anchos
plateau à larges bords



hochglanzpoliert
mirror polished finish
acabado espejo pulido
effet brillant



11210
GN1/2



11211

| | cm | cm | GN |
|---------|-------------|----|-----|
| 11220 9 | 53 x 32,5 | 2 | 1/1 |
| 11210 0 | 32,5 x 26,5 | 2 | 1/2 |
| 11211 7 | Ø 46 | 2 | |

Tablett „SUNDAY“
tray
bandeja
plateau



hochglanzpoliert, Griffe inkl. Fixierung, kein Verrutschen möglich, Nutzhöhe 4 cm
mirror polished finish, with handles for extra secure stacking, distance 4 cm
pulido espejo, con 2 asas para apilado muy estable, distancia 4 cm entre bandejas
effet brillant, 2 anses pour empilement très stable, distance 4 cm entre plateaux



11222
GN1/1

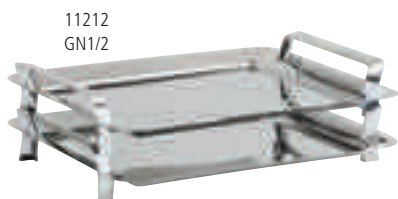

11212
GN1/2

| | cm | cm | GN |
|---------|-------------|----|-----|
| 11222 3 | 53 x 32,5 | 6 | 1/1 |
| 11212 4 | 32,5 x 26,5 | 6 | 1/2 |



Kühlbox „SUNDAY“
cooling plate
bandeja refrigerada
présentoir buffet réfrigéré

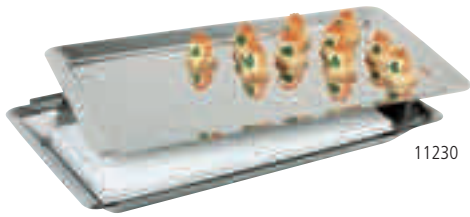

11230

3-teilig: 1 Schale inkl. Haubenfixierung + 1 Tablett + 1 Kühlakku, hochglanzpoliert, ohne Haube

3 pcs. set: 1 tray with cover holder + 1 tray + 1 cooler, mirror polished finish, without rolltop cover

Set 3 pz: bandeja inox con fijaciones para campana, bandeja inox, 1 acumulador de frío, campana no incluida.

Set 3 pc: plateau inox avec fixations pour la cloche, plateau inox, 1 accum. de froid, cloche non incluse

| | □ cm | ↑ cm | GN |
|---------|-----------|------|-----|
| 11230 8 | 53 x 32,5 | 5 | 1/1 |

mit Haubenfixierung



11016

Einzelteile / spare parts / piezas sueltas / pièces détachées

Rolltop-Haube GN1/1 / rolltop cover GN 1/1
 campana rolltop GN 1/1 / cloche rolltop GN 1/1

| | | | |
|---------|-----------|----|--|
| 11016 8 | 53 x 32,5 | 19 | |
|---------|-----------|----|--|

Kühlakku / cooler / acumulador de frío / accumulateur de froid

| | | | |
|---------|---------|-----|--|
| 10782 3 | 41 x 21 | 2,5 | |
|---------|---------|-----|--|



10782

Buffet-Gestell „SUNDAY“
buffet stand
expositor
présentoir buffet



3-teiliges Set: 1 Glasschalen Ø 23 cm 2,5 Liter, 1 klappbarer Schutzdeckel, 1 Gestell

3 pcs. set: 1 glass bowls Ø 23 cm 2.5 litres, 1 hinged covers, 1 stand

3 piezas, 1 bol vidrio Ø 23 cm, 2,5 l, 3 tapas con bisagra, 1 soporte

3 éléments: 1 bol verre Ø 23 cm 2,5 l, 1 couvercle à charnière, 1 support

| | □ cm | ↑ cm |
|---------|------|------|
| 11794 5 | Ø 24 | 17 |

Buffet-Gestell „SUNDAY“
buffet stand
expositor buffet
présentoir buffet



7-teiliges Set: 3 Glasschalen Ø 23 cm 2,5 Liter, 3 klappbare Schutzdeckel, 1 Gestell

7 pcs. set: 3 glass bowls Ø 23 cm 2.5 litres, 3 hinged covers, 1 stand

7 piezas, 3 bols vidrio Ø 23 cm, 2,5 l, 3 tapas con bisagra, 1 soporte

7 éléments: 3 bols verre Ø 23 cm 2,5 l, 3 couvercles à charnière, 1 support

| | □ cm | ↑ cm |
|---------|---------|------|
| 11795 2 | 61 x 24 | 35 |

Buffet-Ständer „BIG“
buffet stand
expositor de bufet
présentoir buffet



7-teiliges Set: 3 Glasschalen Ø 23 cm 2,5 Liter, 3 klappbare Schutzdeckel, 1 Ständer
7 pcs. set: 3 glass bowls Ø 23 cm 2.5 litres, 3 hinged covers, 1 stand
7 piezas, 3 bols vidrio Ø 23 cm, 2,5 l, 3 tapas con bisagra, 1 soporte
7 éléments: 3 bols verre Ø 23 cm 2,5 l, 3 couvercles à charnière, 1 support

| | cm | cm | |
|---------|---------|----|--|
| 11892 8 | 50 x 50 | 18 | |

Einzelteile / spare parts / piezas sueltas / pièces détachées

Schale „CASUAL MAXI“ / bowl / cuenco / bol

| | cm | cm | ltr. | |
|---------|------|------|------|---|
| 83702 7 | Ø 23 | 10,5 | 2,50 | ○ |
| 83703 4 | Ø 23 | 10,5 | 2,50 | ● |



7-teiliges Set



passende Schale:
83702 - weiß
2,5 ltr.



passende Schale:
83702 - schwarz
2,5 ltr.



7-teiliges Set

Buffet-Ständer „LITTLE“
buffet stand
expositor buffet
présentoir buffet



7-teiliges Set: 3 Glasschalen Ø 14 cm 0,5 Liter, 3 klappbare Schutzdeckel, 1 Ständer
7 pcs. set: 3 glass bowls Ø 14 cm 0,5 l, 3 hinged covers, 1 stand
7 piezas, 3 bols vidrio Ø 14 cm, 0,5 l, 3 tapas con bisagra, 1 soporte
7 éléments: 3 bols verre Ø 14 cm 0,5 l, 3 couvercles à charnière, 1 support

| | cm | cm | |
|---------|---------|----|--|
| 11893 5 | 30 x 30 | 14 | |

Einzelteile / spare parts / piezas sueltas / pièces détachées

Schale „CASUAL MAXI“ / bowl / cuenco / bol

| | cm | cm | ltr. | |
|---------|------|-----|------|---|
| 83700 3 | Ø 14 | 6,5 | 0,50 | ○ |
| 83701 0 | Ø 14 | 6,5 | 0,50 | ● |



passende Schale:
83700 - weiß
0,5 ltr.



passende Schale:
83701 - schwarz
0,5 ltr.

NEW

Vorratsdose mit Deckel
canister with lid
contenedor con tapa
pot en verre avec couvercle



Glaskugel mit Schraubdeckel, aromadichtem Verschluss, 1 Stck.
glass ball, aroma-tight screw cap, 1 pc.
bola de cristal, tapa de rosca aroma apretado, 1 pc.
boule de verre, bouchon à vis de l'arôme étanche, 1 pz.

| | cm | cm | ltr. |
|---------|-----------|----|------|
| 00637 9 | 12,5 x 19 | 18 | 1 |





Buffet-Ständer „GOOD MORNING“
buffet stand
expositor de bufet
présentoir à céréales



4-teiliges Set
Ahorn - 13965

4-teiliges Set: Holzständer inkl. 3 Gläser mit luftdichtem Klappdeckel
4 pcs. set: wood stand included 3 glass with airtight cover
4 pz. soporte, 3 bols de cristal
4 pc. présentoir, 3 bols en verre

| | cm | | |
|---------|---------|---------------------------|---|
| 13965 7 | 43 x 17 | Holz, Ahorn / wood, maple | ● |
| 14965 6 | 43 x 17 | Holz, Wenge / wood, wenge | ● |



4-teiliges Set
Wenge - 14965

Einzelteile / spare parts / piezas sueltas / pièces détachées

Glas / glas / cristal / verre

| | cm | ↑ cm | ltr. |
|---------|---------|------|------|
| 82328 0 | 12 x 12 | 22 | 2 |



luftdichter
Klappdeckel

82328
2 ltr.

Idealer
Müsli-Ständer!

Buffet. Banquet
buffet. banquet



Cerealienspender „FRESH & EASY“
cereal dispenser
dispensador de cereales
distributeur de céréales



11805
4,5 ltr.

Behälter herausnehmbar, „Feierabend-Deckel“ für das aromadichte Lagern, portionieren durch einfaches Drehen

removable canister, special lid to keep the cereals fresh, easy to use, rotate the button to get the muesli

contenedor movable, tapa especial para mantener los cereales frescos, fácil de usar, se gira el pomo para servir los cereales

réipient amovible, couvercle spécial pour conserver les céréales, usage facile en tournant le bouton

| | cm | ↑ cm | ltr. |
|---------|-----------|------|---------|
| 11805 8 | 22 x 17,5 | 52 | 4,5 |
| 11807 2 | 22 x 35 | 52 | 2 x 4,5 |

Einzelteile / spare parts / piezas sueltas / pièces détachées

Kunststoffbehälter / canister / contenedor / réipient

| | |
|---------|-----|
| 11808 9 | 4,5 |
|---------|-----|

Portionieren
durch einfaches
„Drehen“



11807
2x 4,5 ltr.

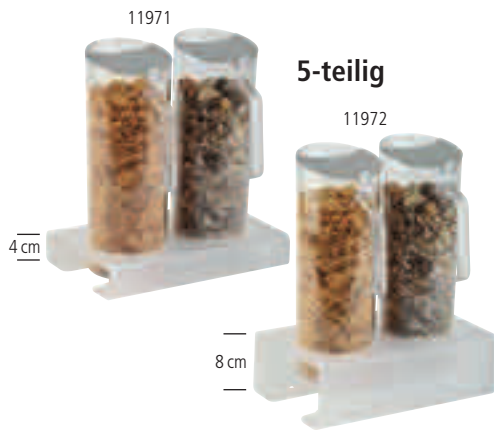

5-teilig

11972



7-teilig

11974



inklusive luftdichtem
Frischhaltedeckel



**ideal für Stufen-
Präsentationen**
die 4 Sets sind durch die
2 unterschiedlichen Höhen
miteinander kombinierbar



best for staged presentations
the 4 sets in 2 heights
can be combined
with each other

Cerealien-Bar
cereal-bar
barra para dispensador de cereales
bar à céréales



5-teiliges Set, mit Ständerhöhe 4 oder 8 cm: 1 Ständer aus Acryl gefrostet und rutschfest + 2 Karaffen mit schwenkbarem Edelstahl-Deckel + 2 luftdichte Frischhaltedeckel

5 pcs. set, with stand heights 4 or 8 cm: 1 stand acryl frosted and anti-slip + 2 pitchers with stainless steel flap lid + 2 airtight covers

set 5 piezas con stands a diferentes alturas, 4 u 8 cm: 1 stand acryl, 2 jarras con tapa de solapa de acero inoxidable + 2 tapas herméticas adicionales

set 5 éléments avec supports à différentes hauteurs: 4 ou 8 cm - 1 support acrylique satiné anti-glisser, 2 pichets à céréales avec couvercle à charnière inox + 2 couvercles hermétiques

| | □ cm | ↑ cm | ltr. |
|---------|---------|------|---------|
| 11971 0 | 26 x 17 | 28,5 | 2 x 1,5 |
| 11972 7 | 26 x 17 | 32,5 | 2 x 1,5 |

7-teiliges Set, mit Ständerhöhe 4 oder 8 cm: 1 Ständer aus Acryl gefrostet und rutschfest + 3 Karaffen mit schwenkbarem Edelstahl-Deckel + 3 luftdichte Frischhaltedeckel

7 pcs. set, with stand heights 4 or 8 cm: 1 stand acryl frosted and anti-slip + 3 pitchers with stainless steel flap lid + 3 airtight covers

set 7 piezas con stands a diferentes alturas, 4 u 8 cm: 1 stand acryl, 3 jarras con tapa de solapa de acero inoxidable + 3 tapas herméticas adicionales

set 7 éléments avec supports à différentes hauteurs: 4 ou 8 cm - 1 support acrylique satiné anti-glisser, 3 pichets à céréales avec couvercle à charnière inox + 3 couvercles hermétiques

| | □ cm | ↑ cm | ltr. |
|---------|---------|------|---------|
| 11973 4 | 38 x 17 | 28,5 | 3 x 1,5 |
| 11974 1 | 38 x 17 | 32,5 | 3 x 1,5 |

Cerealien-Karaffe
cereal pitcher
jarra de cereales
pichet à céréales



schwenkbarer Edelstahl-Deckel, inkl. luftdichtem Frischhaltedeckel

stainless steel flap lid, incl. 1 airtight cover

tapa de solapa de acero inoxidable, incluye otra tapa hermética

couvercle à charnière inox + couvercle hermétique

| | □ cm | ↑ cm | ltr. |
|---------|------|------|------|
| 10778 6 | Ø 10 | 28 | 1,5 |

Frischhaltedeckel / includes conservation airtight lid

tapa de conservación hermética incluida / inclut couvercle hermétique

10668 0



inklusive luftdichtem
Frischhaltedeckel



designed by **CULTURE FORM**

Cerealienspender „BRIDGE“
cereal dispenser
dispensador de cereales
distributeur de céréales



Behälter herausnehmbar, „Feierabend-Deckel“ für das aromadichte Lagern, portionieren durch einfaches Drehen

removable canister, special lid to keep the cereals fresh, easy to use, rotate the button to get the muesli

contenedor movible, tapa especial para mantener los cereales frescos, fácil de usar, se gira el pomo para servir los cereales

réipient amovible, couvercle spécial pour conserver les céréales, usage facile en tournant le bouton



14987
Ahorn



14987
Wenge

| | ☐ cm | ↑ cm | litr. | | |
|---------|---------|------|-------|-------|---|
| 13987 9 | 21 x 20 | 55,5 | 4,5 | Ahorn | ● |
| 14987 8 | 21 x 20 | 55,5 | 4,5 | Wenge | ● |

Cerealienspender „CLASSIC“
cereal dispenser
dispensador de cereales
distributeur de céréales



8 ltr.

Portionieren durch einfaches Drehen, Behälter herausnehmbar

canister removable

contenedor movible

réipient amovible

| | ☐ cm | ↑ cm | litr. |
|---------|-----------|------|-------|
| 11833 1 | 35 x 26,5 | 68 | 8 |

Portionieren
durch
einfaches "Drehen"



Cerealienspender „CLASSIC DUO“
cereal dispenser
dispensador de cereales
distributeur de céréales



2 x 8 ltr.

Portionieren durch einfaches Drehen, Behälter herausnehmbar

canister removable

contenedor movible

réipient amovible

| | ☐ cm | ↑ cm | litr. |
|---------|---------|------|-------|
| 11834 8 | 35 x 50 | 68 | 2 x 8 |

Portionieren
durch
einfaches "Drehen"



EAN = 40 04 133 XXXXX X

195

3 x
4,5 ltr.



Top-Qualität
bruchfest durch
Polycarbonat

Cerealienspender „ROTATION“
cereal dispenser
dispensador de cereales
distributeur de céréales



matt poliert, drehbarer massiver Ständer, Behälter herausnehmbar, inkl. Frischhaltedeckel
satin polished finish, rotating food, canister removable, incl. airtight covers
pulido acabado satinado, giratorio, incluye tapas herméticas
mat satiné, rotatif, inclut couvercles hermétiques

| | ☐ cm | ↑ cm | ltr. |
|---------|------|------|---------|
| 11970 3 | Ø 38 | 54 | 3 x 4,5 |

Einzelteile / spare parts / piezas sueltas / pièces détachées

Kunststoffbehälter / canister / contenedor / récipient

11808 9

3 x
4,5 ltr.



Top-Qualität
bruchfest durch
Polycarbonat

Cerealienspender „ROTATION“
cereal dispenser
dispensador de cereales
distributeur de céréales



Buchen-Holz versiegelt, drehbarer massiver Ständer, Behälter herausnehmbar, inkl. Frischhaltedeckel
wood beech covered waterproof, rotating foot, canister removable, incl. airtight cover
tapa en madera de haya resistente al agua, pie giratorio, recipiente removible, incluye tapa hermética
couverture en hêtre traitée contre l'humidité, pied rotatif, récipients démontables, inclut couvercles hermétiques

| | ☐ cm | ↑ cm | ltr. |
|---------|------|------|---------|
| 11975 8 | Ø 38 | 54 | 3 x 4,5 |

Einzelteile / spare parts / piezas sueltas / pièces détachées

Kunststoffbehälter / canister / contenedor / récipient

11808 9



**Service-Tower
service tower
service tower
tour de service**



Präsentations- und Spendersystem, bei minimalen Platzbedarf, optimale Wertschöpfung, zum Beispiel im Bereich der Besteckausgabe, Kaffeestationen, Speiseausgaben, Verkaufstheken, etc.

Presentation and dispenser System, the products find their best creation of value at minimal need of space, for example in the range of Coffeestations, food service, counters etc.

sistema de presentación y dispensador, con el mínimo espacio conseguirá una excelente presentación de sus productos, por ejemplo en la zona del café, comidas, etc

système de présentation et distribution. Très élégant dans un espace minimum, idéal pour la zone café, coin repas, etc



5 oder 6-teilig: Basisfuß + Rückwand aus dunklem Holz

5 or 6 pcs. set: base + backplane made of dark wood

Set de 5 o 6 elementos: base + trasera de madera oscura

Set de 5 ou 6 éléments: socle + paroi en bois foncé

| | □ cm | ↑ cm | |
|---------|---------|------|--|
| 11431 9 | 26 x 18 | 43 | 2x Schütte, tief + 1x Schütte, flach 2 deep one + 1 flat one 2 honda + 1 plana 2 profunde + 1 plate |
| 11421 0 | 26 x 18 | 57,5 | 2x Schütte, tief + 2x Schütte, flach 2 deep ones + 2 flat ones 2 rampas hondas + 2 planas 2 rampes profunde + 2 plate |
| 11432 6 | 26 x 18 | 43 | 3x Schütte, tief / 3 bowls, deep ones 3 rampas hondas / 3 rampes profunde |
| 11422 7 | 26 x 18 | 57,5 | 4x Schütte, tief / 4 bowls, deep ones 4 rampas hondas / 4 rampes profunde |



5 oder 6-teilig: Basisfuß + Rückwand aus Acryl gefrostet

5 or 6 pcs. set: base + backplane made of acrylic frosted

Set de 5 o 6 elementos: base + trasera de acrilico opaco mate

Set de 5 ou 6 éléments: socle + paroi en acrylique mat

| | | | |
|---------|---------|------|--|
| 11433 3 | 26 x 18 | 43 | 2x Schütte, tief + 1x Schütte, flach 2 deep one + 1 flat one 2 honda + 1 plana 2 profunde + 1 plate |
| 11423 4 | 26 x 18 | 57,5 | 2x Schütte, tief + 2x Schütte, flach 2 deep ones + 2 flat ones 2 rampas hondas + 2 planas 2 rampes profunde + 2 plate |
| 11434 0 | 26 x 18 | 43 | 3x Schütte, tief / 3 bowls, deep ones 3 rampas hondas / 3 rampes profunde |
| 11424 1 | 26 x 18 | 57,5 | 4x Schütte, tief / 4 bowls, deep ones 4 rampas hondas / 4 rampes profunde |

Einzelteile / spare parts / piezas sueltas / pièces détachées

Basisfuß / base / pie de la base / pied de la base

11435 7

Rückwand Holz / backplane made of wood / trasera de madera / arrière bois

11436 4 44,5 x 24 für 3 Schütten

11426 2 60 x 24 für 4 Schütten

Rückwand Acryl / backplane made of acrylic / trasera acrílica / arrière acrylique

11437 1 44,5 x 24 für 3 Schütten

11427 2 60 x 24 für 4 Schütten

Schütte, tief / bowl, deep / rampa, honda / rampe profunde

11438 8 22 x 14 7 / 5

Schütte, flach / bowl / rampa plana / rampe plate

11439 5 22 x 13 3 / 1





Multi-Rack
multi rack
dispensador en escalera
support multiple



2-stufig, 3-teilig: 1 Gestell matt poliert + 2 Schütten aus transparent gefrostetem Kunststoff, je ca. 1 Liter

2-tier, 3 pcs. set: 1 frame satin polished finish + 2 bowls frosted plastic, approx. 1 liter

2 alturas - set 3 pz: 1 soporte inox mate satinado, 2 bols plástico glaseado, aprox. 1 litro

2 niveaux - Set de 3 éléments, 1 support satiné, 2 bols plastique mat, approx. 1 litre

| | ☐ cm | ↑ cm |
|---------|---------|------|
| 11442 5 | 19 x 24 | 28 |



Multi-Rack
multi rack
dispensador en escalera
support multiple



3-stufig, 4-teilig: 1 Gestell matt poliert + 3 Schütten aus transparent gefrostetem Kunststoff, je ca. 1 Liter

3-tier, 4 pcs. set: 1 frame satin polished finish + 3 bowls frosted plastic, approx. 1 liter

3 alturas, set de 4 piezas, 1 estructura inox satinado + 3 bols de plástico glaseado, aprox, 1 litro

3 niveaux - Set de 4 éléments: 1 structure inox poli satin, 3 bols plastique mat, approx. 1 litre

| | ☐ cm | ↑ cm |
|---------|---------|------|
| 11444 9 | 19 x 24 | 41 |



Multi-Rack
multi rack
dispensador en escalera
support multiple



3-stufig, 4-teilig: 1 Gestell matt poliert + 2 Schütten aus transparent gefrostetem Kunststoff, je ca. 1 Liter + 1 Rutsche aus transparent gefrostetem Kunststoff

3-tier, 4 pcs. set: 1 frame satin polished finish + 2 bowls frosted plastic, approx. 1 liter + 1 slide frosted plastic

3 alturas, set de 4 piezas, 1 estructura inox satinado + 2 bols de plástico glaseado, aprox, 1 litro + 1 bol „tobogán“ en plástico glaseado

3 niveaux - Set de 3 éléments: 1 structure inox poli satin, 2 bols plastique mat approx. 1 litre + 1 bol avec „toboggan“

| | ☐ cm | ↑ cm |
|---------|---------|------|
| 11447 0 | 19 x 24 | 41 |



Multi-Rack
multi rack
dispensador en escalera
support multiple



3-stufig, 4-teilig: 1 Gestell matt poliert + 1 Schütte aus transparent gefrostetem Kunststoff, ca. 1 Liter + 2 Rutschen aus transparent gefrostetem Kunststoff

3-tier, 4 pcs. set: 1 frame satin polished finish + 1 bowl frosted plastic, approx. 1 liter + 2 slides frosted plastic

3 alturas, set de 4 piezas, 1 soporte inox satinado + 1 bol de plástico glaseado, aprox, 1 litro + 2 bols con „tobogán“ en plástico glaseado

3 niveaux - Set de 4 éléments: 1 structure inox poli satin, 1 bol plastique mat approx. 1 litre + 2 bols avec „toboggan“

| | ☐ cm | ↑ cm |
|---------|---------|------|
| 11449 4 | 19 x 24 | 41 |



**Multi-Rack
multi rack
dispensador en escalera
support multiple**



4-stufig, 5-teilig: 1 Gestell matt poliert + 4 Schütten aus transparent gefroretetem Kunststoff, je ca. 1 Liter

4-tier, 5 pcs. set: 1 frame satin polished finish + 4 bowls frosted plastic, approx. 1 liter

4 alturas, set de 5 piezas, 1 estructura inox satinado + 4 bols de plástico glaseado, aprox, 1 litro

4 niveaux - Set de 5 éléments: 1 structure inox poli satin, 4 bols plastique mat, approx. 1 litre

| | ☐ cm | ↑ cm |
|---------|---------|------|
| 11446 3 | 19 x 31 | 53 |



**Multi-Rack
multi rack
dispensador en escalera
support multiple**



4-stufig, 5-teilig: 1 Gestell matt poliert + 3 Schütten aus transparent gefroretetem Kunststoff, je ca. 1 Liter + 1 Rutsche aus transparent gefroretetem Kunststoff

4-tier, 5 pcs. set: 1 frame satin polished finish + 3 bowls frosted plastic, approx. 1 liter + 1 slide frosted plastic

4 alturas, set de 5 piezas, 1 estructura inox satinado + 3 bols de plástico glaseado, aprox, 1 litro + 1 bol con „tobogán“ de plástico efecto glaseado

4 niveaux - Set de 5 éléments: 1 structure inox poli satin, 3 bols plastique mat approx. 1 litre + 1 bol avec „toboggan“

| | ☐ cm | ↑ cm |
|---------|---------|------|
| 11451 7 | 19 x 31 | 53 |

11455
Schütte



11456
Rutsche



**Ergänzung für alle Multi-Racks
supplement for all multi racks
suplemento para todos los dispensadores
compléments pour support Multi-Rack**



Gestelle matt poliert, Schütte und Rutsche aus transparent gefroretetem Kunststoff

frames stainless steel, bowl and slide frosted plastic

estructura acero inoxidable, Bol y tobogán de plástico glaseado

support inox. Bol et „toboggan“ en plastique mat

| | |
|---------|--|
| 11642 4 | Gestell, 2-stufig / frame, 2-tier estructura 2 alturas / support 2 hauteurs |
| 11644 1 | Gestell, 3-stufig / frame, 3-tier estructura 3 alturas / support 3 hauteurs |
| 11646 7 | Gestell, 4-stufig / frame, 4-tier estructura 4 alturas / support 4 hauteurs |
| 11455 5 | Schütte / canister / bol / bol |
| 11456 2 | Rutsche / slide / tobogan / toboggan |



**Schälchenspender „MINI“
bowl holder
rack dispensador para bols
porte-bols**

geeignet für Schalen Ø 6 cm, bestückbar mit bis zu 36 Schalen
for bowls Ø 6 cm, suitable for 36 bowls
para bols de Ø 6 cm, apto para 36 bols
pour bols de 6 cm, maxi 36 bols

| | ☐ cm | ↑ cm | |
|---------|------|------|--|
| 11981 9 | Ø 14 | 25,5 | Ständer inkl. 36 Glasschalen, Ø 6 cm frame with 36 bowls, Ø 6 cm soporte con 36 bols, Ø 6 cm support livré avec 36 bols en verre Ø 6 cm |
| 11980 2 | Ø 14 | 25,5 | Ständer ohne Schalen frame without bowls soporte sin bols support sans bols |



**Schälchenspender „MEDIUM“
bowl holder
rack dispensador para bols
porte-bols**

geeignet für Schalen Ø 7,5 cm, bestückbar mit bis zu 36 Schalen
for bowls Ø 7,5 cm, suitable for 36 bowls
para bols de Ø 7,5 cm, apto para 36 bols
pour bols de 7,5 cm, maxi 36 bols

| | ☐ cm | ↑ cm | |
|---------|--------|------|--|
| 11991 8 | Ø 17,5 | 25,5 | Ständer inkl. 36 Glasschalen, Ø 7,5 cm frame with 36 bowls, Ø 7,5 cm soporte con 36 bols, Ø 7,5 cm support livré avec 36 bols en verre Ø 7,5 cm |
| 11990 1 | Ø 17,5 | 25,5 | Ständer ohne Schalen frame without bowls soporte sin bols support sans bols |

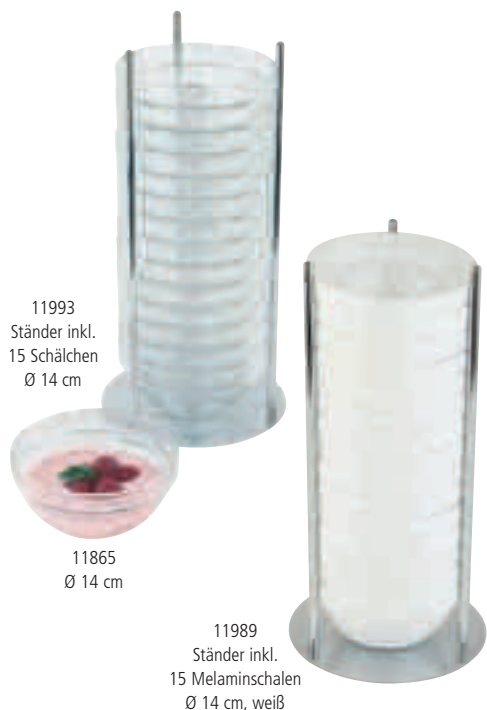

**Schälchenspender „MAXI“
bowl holder
rack dispensador para bols
porte-bols**

geeignet für Schalen Ø 14 cm, bestückbar mit bis zu 15 Schalen
for bowls Ø 14 cm, suitable for 15 bowls
para bols Ø 14cm, apto para 15 bols
pour bols Ø 14cm, pour 15 bols

| | ☐ cm | ↑ cm | |
|---------|--------|------|---|
| 11993 2 | Ø 17,5 | 36,5 | Ständer inkl. 15 Glasschalen, Ø 14 cm frame with 15 bowls, Ø 14 cm soporte con 15 bols, Ø 14 cm support livré avec 15 bols en verre Ø 14 cm |
| 11989 5 | Ø 17,5 | 36,5 | Ständer inkl. Melaminschalen, Ø 14 cm frame with melamine bowls, Ø 14 cm soporte con bols de melamina Ø 14 cm support livré avec 15 bols en mélamine Ø 14 cm |
| 11992 5 | Ø 17,5 | 36,5 | Ständer ohne Schalen frame without bowls soporte sin bols support sans bols |



Schälchenspender „MINI“
bowl holder
rack dispensador para bols
porte-bols



geeignet für Schalen Ø 6 cm, bestückbar mit bis zu 36 Schalen
 for bowls Ø 6 cm, suitable for 36 bowls
 para bols de Ø 6 cm, apto para 36 bols
 pour bols de 6 cm, maxi 36 bols

| | ☐ cm | ↑ cm | |
|---------|------|------|--|
| 11986 4 | Ø 14 | 25,5 | Ständer inkl. 36 Melaminschalen, Ø 6 cm frame with 36 melamine bowls, Ø 6 cm soporte con 36 bols de melamina Ø 6 cm support avec 36 bols en mélamine Ø 6 cm |
| 11980 2 | Ø 14 | 25,5 | Ständer ohne Schalen frame without bowls soporte sin bols support sans bols |



Schälchenspender „MEDIUM“
bowl holder
rack dispensador para bols
porte-bols



geeignet für Schalen Ø 7,5 cm, bestückbar mit bis zu 36 Schalen
 for bowls Ø 7,5 cm, suitable for 36 bowls
 para bols de Ø 7,5 cm, apto para 36 bols
 pour bols de 7,5 cm, maxi 36 bols

| | ☐ cm | ↑ cm | |
|---------|--------|------|---|
| 11987 1 | Ø 17,5 | 22,5 | Ständer inkl. 36 Melaminschalen, Ø 7,5 cm frame with 36 melamine bowls, Ø 7,5 cm soporte con 36 bols de melamina, Ø 7,5 cm support avec 36 bols en mélamine Ø 7,5 cm |
| 11990 1 | Ø 17,5 | 25,5 | Ständer ohne Schalen frame without bowls soporte sin bols support sans bols |

Buffet. Banquet
buffet. banquet



Schälchen „CASUAL MINI“
bowl
bol
bol mini



| | ☐ cm | ↑ cm | ltr. | |
|---------|-------|------|------|---|
| 83880 2 | Ø 6 | 2,5 | 0,02 | ○ |
| 83881 9 | Ø 7,5 | 3,5 | 0,05 | ○ |



Schale „CASUAL MAXI“
bowl
cuenco
bol



| | ☐ cm | ↑ cm | ltr. | |
|---------|------|------|------|---|
| 83700 3 | Ø 14 | 6,5 | 0,50 | ○ |
| 83701 0 | Ø 14 | 6,5 | 0,50 | ● |

BUFFET-SET PURE designed by CULTURE FORM



stapelbar
stackable
apilables
empilable



mit Antirutsch-Füßchen
non-slip feet
con pies antideslizantes
avec pieds anti-dérapants

Auslage Tablett
40 x 30 cm - 40296



Basisteil
schwarz - 09012



Basisteil
schwarz - 09012

Set, 4-teilig
09000



Schneidebrett
09016



Basisteil
09011



Edelstahltablett
09010



Rolltop-Haube
09013

Kühl-Akkus halten
Ihre Speisen bis
zu 6 Stunden kühl

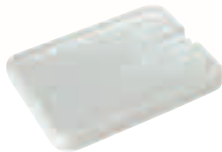

Buffet-Set, eckig „PURE“
buffet set, rectangular
set de buffet, rectangulaire
présentoir pour le buffet, rectangulaire



4-teilig: Box, Tablett, 2 Kühlakkus
4 pcs.: box, tray, 2 cooler
4 piez.: box, bandeja, 2 enfriador
4 éléments: caisson, 2 plateau, bac

| | cm | cm | |
|---------|-------------|----|---|
| 09000 2 | 43,5 x 32,5 | 6 | ○ |
| 09001 9 | 43,5 x 32,5 | 6 | ● |

Einzelteile / spare parts / piezas sueltas / pièces détachées

Edelstahltablett / tray / bandeja / plateau

| | | | |
|---------|-------------|-----|--|
| 09010 1 | 43,5 x 32,5 | 1,5 | |
|---------|-------------|-----|--|

Basisteil / base / base / base

| | | | |
|---------|-------------|---|---|
| 09011 8 | 42,5 x 31,5 | 6 | ○ |
| 09012 5 | 42,5 x 31,5 | 6 | ● |

Rolltop-Haube / rolltop cover / campana abatible / cloche basculante

| | | | |
|---------|-----------|----|--|
| 09013 2 | 44 x 33,5 | 17 | |
|---------|-----------|----|--|

Holzschneidebrett / wooden board / tablero de madera / planche à découper

| | | | |
|---------|-------------|---|---------------|
| 09016 3 | 43,5 x 32,5 | 2 | Ahorn / maple |
|---------|-------------|---|---------------|

Auslage Tablett flach (Bäcker-Maß) / display tray flat (baker size)

bandeja de presentación (tamaño panadería) / plateau de présentation (dimensions boul-pâte)

| | | | |
|---------|---------|---|--|
| 40296 6 | 40 x 30 | 1 | |
|---------|---------|---|--|

Kühlakku / cooler / acumulador de frío / accumulateur de froid

| | | | |
|---------|---------|-----|---|
| 10791 5 | 25 x 19 | 2,5 | ○ |
|---------|---------|-----|---|



Set, 3-teilig
09003

Rolltop-Haube
09023



Set, 3-teilig (ohne Haube)
09003

Edelstahltablett
09020



Kühl-Akkus halten
Ihre Speisen bis
zu 6 Stunden kühl

Buffet-Set, rund „PURE“
buffet set, round
set de buffet, redonda
présentoir pour le buffet, rond



3-teilig: Box, Tablett, 1 Kühlakku
3 pcs.: box, tray, 1 cooler
3 piez.: box, bandeja, 1 enfriador
3 éléments: caisson, 1 plateau, bac

| | cm | cm | |
|---------|------|----|---|
| 09002 6 | Ø 38 | 6 | ○ |
| 09003 3 | Ø 38 | 6 | ● |

Einzelteile / spare parts / piezas sueltas / pièces détachées

Edelstahltablett / tray / bandeja / plateau

| | | | |
|---------|------|-----|--|
| 09020 0 | Ø 38 | 1,5 | |
|---------|------|-----|--|

Basisteil / base / base / base

| | | | |
|---------|------|---|---|
| 09021 7 | Ø 37 | 6 | ○ |
| 09022 4 | Ø 37 | 6 | ● |

Rolltop-Haube / rolltop cover / campana abatible / cloche basculante

| | | | |
|---------|------|----|--|
| 09023 1 | Ø 38 | 20 | |
|---------|------|----|--|

Holzschneidebrett / wooden board / tablero de madera / planche à découper

| | | | |
|---------|------|---|---------------|
| 09026 2 | Ø 38 | 2 | Ahorn / maple |
|---------|------|---|---------------|

Kühlakku / cooler / acumulador de frío / accumulateur de froid

| | | | |
|---------|---------|-----|---|
| 10791 5 | 25 x 19 | 2,5 | ○ |
|---------|---------|-----|---|

designed by **CULTURE FORM**



**Buffet-Brett „FISCH“
board
tabla para el buffet
planche à découper buffet**



Buchenholz, mit Antirutsch-Füßchen
beech wood, with non-slip feet
haya, pies antideslizantes
hêtre, pieds anti-dérapants

| | cm | cm |
|---------|---------|-----|
| 00860 1 | 76 x 23 | 2,5 |

designed by **CULTURE FORM**



**Buffet-Brett „RIND“
board
tabla para el buffet
planche à découper buffet**



Buchenholz, mit Antirutsch-Füßchen
beech wood, with non-slip feet
haya, pies antideslizantes
hêtre, pieds anti-dérapants

| | cm | cm |
|---------|---------|-----|
| 00861 8 | 62 x 34 | 2,5 |

designed by **CULTURE FORM**



**Buffet-Brett „SCHWEIN“
board
tabla para el buffet
planche à découper buffet**



Buchenholz, mit Antirutsch-Füßchen
beech wood, with anti-slip feet
haya, pies antideslizantes
hêtre, pieds anti-dérapants

| | cm | cm |
|---------|---------|-----|
| 00862 5 | 66 x 30 | 2,5 |

designed by **CULTURE FORM**



18388

**Buffet-Brett „TRAUBE“
board
tabla para el buffet
planche à découper buffet**



Buchenholz, Antirutsch-Füßchen
beech wood, non-slip feet
haya, pies antideslizantes
hêtre, pieds anti-dérapants

| | cm | cm |
|---------|-----------|-----|
| 00863 2 | 43,5 X 38 | 2,5 |

Rolltophaube / rolltop cover / campana abatible / cloche basculante

| | | |
|---------|------|----|
| 18388 9 | Ø 38 | 20 |
|---------|------|----|

designed by **CULTURE FORM**

Buffet-Brett „XXL“
board
tabla para el buffet
planche à découper buffet



Buchenholz geölt, mit Antirutsch-Füßchen
 beech wood, with non-slip feet
 haya, pies antideslizantes
 hêtre, pieds anti-dérapants

| | ☐ cm | ↑ cm |
|---------|------|------|
| 00866 3 | Ø 50 | 4,5 |



passende Rolltophaube / suitable rolltop cover / campana abatible / cloche basculante

| | | |
|---------|------|----|
| 18380 3 | Ø 50 | 26 |
|---------|------|----|

designed by **CULTURE FORM**

Buffet-Brett
board
tabla para el buffet
planche à découper buffet



Buchenholz, mit Antirutsch-Füßchen
 beech wood, with non-slip feet
 haya, pies antideslizantes
 hêtre, pieds anti-dérapants

| | ☐ cm | ↑ cm |
|---------|---------|------|
| 00865 6 | 58 x 38 | 2,5 |

passende Rolltophaube / suitable rolltop cover / campana abatible / cloche basculante

| | ☐ cm | ↑ cm | Seite/page |
|---------|-------------|------|------------|
| 11016 8 | 53 x 32,5 | 19 | 169 |
| 11008 3 | 53 x 32,5 | 19 | 189 |
| 11010 6 | 53,0 x 32,5 | 19 | 189 |



Griffmulde



3-tlg. Set



Haube mit verchromten Griff

Käseglocken-Set „BRAZIL“
rolltop-set
set rolltop
set cloche à fromage



3-teilig: Tablett + Holzschneidebrett + Rolltop-Haube glasklar, rutschfeste Haubenfixierung
3 pcs. set: tray + wooden board + rolltop cover, cover non-slip fixed
set de 3 piezas: bandeja + tablero de madera + campana abatible, fijación antideslizante
set 3 pièces: 1 plateau + 1 planche à découper + 1 cloche abattante fixation anti-glisse

| | ☐ cm | ↑ cm |
|---------|------|------|
| 09085 9 | Ø 45 | 24 |

Rolltop-Set
rolltop-set
set rolltop
set cloche à fromage



Ø 38 cm

2-tlg. Set
09080

Ø 38 cm!

2-teilig: Tablett + Rolltop-Haube glasklar, rutschfeste Haubenfixierung
2 pcs. set: tray + rolltop cover, cover non-slip fixed
2 alturas: bandeja + campana abatible fijación antideslizante
2 alturas: plateau + cloche abattante fixation anti-glisse

| | ☐ cm | ↑ cm |
|---------|------|------|
| 09080 4 | Ø 38 | 24 |
| 09099 6 | Ø 50 | 28 |



2-tlg. Set
09099

Ø 50 cm!

klappbar



Haube mit verchromten Griff
2-tlg. Set

Rolltop-Set
rolltop-set
set rolltop
set rolltop



2-teilig: Schneidbrett marmoriert + Rolltop-Haube glasklar, rutschfeste Haubenfixierung
2 pcs. set: plastic board + rolltop cover, cover non-slip fixed
2 alturas: tablero de plástico + tapa abatible, tapa antideslizante
2 hauteurs: planche à découper + cloche abattante fixation anti-glisse

| | cm | cm | |
|---------|------|----|--|
| 09081 1 | Ø 38 | 24 | |



bis 90°
aufklappbar

Ø 38 cm
00978
2-tlg. Set

Buffet-Set
buffet set
set de buffet
présentoir pour le buffet



2-teilig: Platte + Rolltop-Haube, schneidfeste und porenfreie Oberfläche, rutschfeste Haubenfixierung, Platte mit rutschfesten Füßen
2 pcs. set: glass board + rolltop cover, scratch-resistant surface, cover non-slip fixed, non-slip feet
set de 2 piezas: bandeja vidrio redonda + campana abatible fijación antideslizante, pies antideslizantes
set de 2 éléments: 1 plateau verre rond + 1 cloche abattante fixation anti-glisse et pieds anti-dérapants

| | cm | cm | |
|---------|------|----|--|
| 00978 3 | Ø 38 | 23 | |

Einzelteile / spare parts / piezas sueltas / pièces détachées

Rolltop-Haube mit Löchern / rolltop cover / campana abatible / cloche basculante

| | | | |
|---------|------|----|--|
| 18394 0 | Ø 38 | 20 | |
|---------|------|----|--|

Glasplatte / glass plate / bandeja de vidrio / plateau verre

| | | | |
|---------|------|---|--|
| 00972 1 | Ø 38 | 3 | |
|---------|------|---|--|



Ø 38 cm

83869

Servierplatte
plate
bandeja para servir
plat de service



mit Antirutsch-Füßchen
non-slip feet
con pies antideslizantes
avec pieds anti-dérapants

| | cm | cm | |
|---------|------|-----|---|
| 83869 7 | Ø 38 | 2,5 | ○ |



18388

passendes Zubehör / suitable accessories
accessorios a juego / accessoires assortis



Rolltop-Haube / rolltop cover / campana abatible / cloche basculante

| | | | |
|---------|------|----|--|
| 18388 9 | Ø 38 | 20 | mit verchromtem Griff chrome plated handle pomo cromado bouton chromé |
|---------|------|----|--|



09100

**Buffet-Vitrine
showcase
vitrina de bufet
vitrine de buffet**



1 transparente Rolltop-Haube beidseitig aufklappbar + 1 Schale (ABS)
+ 1 Edelstahl-Tablett 39 x 28 cm + 2 Kühl-Akkus

1 transparent rolltop cover + 1 tray (ABS) + 1 stainless tray 39 x 28 cm + 2 coolers,
demountable

1 tapa abatible transparente + 1 bandeja (ABS) + 1 bandeja 39x28cm + 2 enfriadores,
desmontable

1 cloche transparente ouverture 2 côtés + 1 caisson (ABS) + 1 plateau inox 39 x 28 cm + 2
accumulateurs de froid, démontable

| | □ cm | ↑ cm | |
|---------|---------|------|---|
| 09100 9 | 44 x 32 | 20,5 | ○ |
| 09102 3 | 44 x 32 | 20,5 | ● |
| 09104 7 | 44 x 32 | 20,5 | ● |



09102

Einzelteile / spare parts / piezas sueltas / pièces détachées

Kühlakku / cooler / acumulador de frío / accumulateur de froid

| | | | |
|---------|----------|-----|--------|
| 11101 1 | 16 x 7,5 | 2,0 | 4 pcs. |
|---------|----------|-----|--------|

Edelstahl-Tablett / stainless steel tray / bandeja de acero inoxidable / plateau inox

| | |
|---------|---------|
| 90902 1 | 39 x 28 |
|---------|---------|



09104

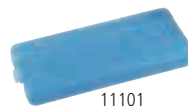

**Kühl-Akkus halten
Ihre Speisen bis
zu 6 Stunden kühl**

11101



blaue Kunststoffschale
und blauer Haubengriff

**Thermo Tablett Set
thermo tray
bandeja termo
caisson thermo**



1 stabile Schale + 1 Edelstahl-Tablett + 2 Kühlakkus + 1 Frischhaltehaube

1 plastic tray + 1 stainless tray + 2 coolers + 1 cover

1 bandeja de plástico + 1 bandeja inox + 2 enfriadores 11101 + 1 campana

1 plateau plastique + 1 plateau inox + 2 accumulateurs de froid + 1 cloche

| | □ cm | ↑ cm |
|---------|---------|------|
| 09090 3 | 43 x 29 | 14 |

Einzelteile / spare parts / piezas sueltas / pièces détachées

Kühlakku / cooler / acumulador de frío / accumulateur de froid

| | | | |
|---------|----------|-----|--------|
| 11101 1 | 16 x 7,5 | 2,0 | 4 pcs. |
|---------|----------|-----|--------|

Haube / cover / campana / cloche

| | | |
|---------|---------|----|
| 90901 4 | 43 x 29 | 14 |
|---------|---------|----|

Edelstahl-Tablett / stainless steel tray / bandeja de acero inoxidable / plateau inox

| | |
|---------|---------|
| 90902 1 | 39 x 28 |
|---------|---------|



11101

**Kühl-Akkus halten
Ihre Speisen bis
zu 6 Stunden kühl**



**Buffet-Vitrine „DOPPELDECKER“
showcase
vitrina de buffet 2 alturas
vitrine de buffet double**



2 transparente Rolltop-Hauben beidseitig aufklappbar + 2 Edelstahl-Tabletts 39 x 28 cm + 4 Kühl-Akkus, platzsparend lagerbar

2 transparent rolltop cover + 2 tray 39 x 28 cm + 4 coolers, demountable, space saving

2 campanas abatibles por ambos lados + 2 bandejas 39 x 28 cm + 4 acumuladores desmontable, ahorra espacio

2 cloches transparentes abattantes 2 côtés + 2 plateaux 39 x 28 cm + 4 accumulateurs de froid , gain d'espace

| | ☐ cm | ↑ cm | |
|---------|---------|------|---|
| 09200 6 | 44 x 32 | 44 | ○ |
| 09202 0 | 44 x 32 | 44 | ● |
| 09204 4 | 44 x 32 | 44 | ● |



Einzelteile / spare parts / piezas sueltas / pièces détachées

Kühlakku / cooler / acumulador de frío / accumulateur de froid

| | | | |
|---------|----------|-----|--------|
| 11101 1 | 16 x 7,5 | 2,0 | 4 pcs. |
|---------|----------|-----|--------|

Edelstahl-Tablett / stainless steel tray / bandeja de acero inoxidable / plateau inox

| | |
|---------|---------|
| 90902 1 | 39 x 28 |
|---------|---------|

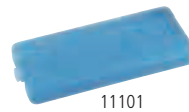

**Kühl-Akkus halten
Ihre Speisen bis
zu 6 Stunden kühl**

11101



blaue
Kunststoffschale

**Thermo Tablett Set
thermo tray
bandeja termo
plateau thermo**



1 stabile Schale + 1 Edelstahl-Tablett rostfrei + 2 Kühlakkus + 1 Frischhaltehaube

1 plastic tray + 1 stainless tray + 2 coolers + 1 cover

1 bandeja de plástico + 1 bandeja de acero inoxidable + 2 enfriadores + 1 campana

1 plateau plastique renforcé + 1 plateau inox + 2 accumulateurs de froid + 1 cloche

| | ☐ cm | ↑ cm |
|---------|------|------|
| 09093 4 | Ø 35 | 15 |

Einzelteile / spare parts / piezas sueltas / pièces détachées

Kühlakku / cooler / acumulador de frío / accumulateur de froid

| | | | |
|---------|----------|-----|--------|
| 11101 1 | 16 x 7,5 | 2,0 | 4 pcs. |
|---------|----------|-----|--------|



**Kühl-Akkus halten
Ihre Speisen bis
zu 6 Stunden kühl**

11101



11540

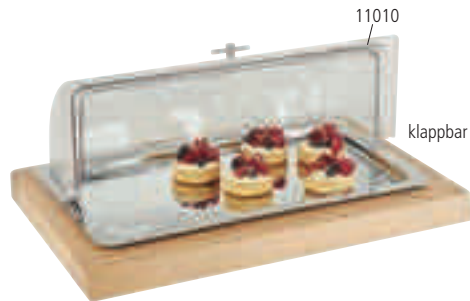

11010

klappbar

Buche (wasserfest lackiert)

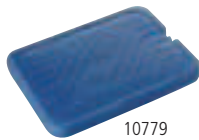

10779

Kühl-Akkus halten
Ihre Speisen bis
zu 6 Stunden kühl

Kühltablett „TOP FRESH GN1/1“ Refrigerated buffet display expositor buffet frío plateau buffet froid



4-teilig: 1 Holzbox mit Kunststoffwanne + 1 Tablett GN1/1 + 2 Kühlakkus

4 pcs. set: 1 woodbox with plastic insert + 1 stainless tray GN1/1 + 2 coolers

Bandeja de frío GN 1/1 - 4 pz: base madera, bandeja inox GN 1/1, 2 acumuladores de frío

Présentoir buffet GN 1/1 4 pc: base bois, plateau inox GN 1/1, 2 accus de froid (cloche non incluse)

| | cm | cm |
|---------|---------|----|
| 11540 8 | 60 x 41 | 5 |

passendes Zubehör / suitable accessories / accesorios a juego / accessoires assortis

Rolltop-Haube GN1/1, vergoldeter Griff / rolltop cover, gold plated handle
campana rolltop, pomo dorado / cloche rolltop, bouton doré

| | | |
|---------|-----------|----|
| 11008 3 | 53 x 32,5 | 19 |
|---------|-----------|----|

Rolltop-Haube GN1/1, verchromter Griff / rolltop cover, chrome plated handle
campana rolltop, pomo cromado / cloche rolltop, bouton chromé

| | | |
|---------|-------------|----|
| 11010 6 | 53,0 x 32,5 | 19 |
|---------|-------------|----|

Kühlakku / cooler / acumulador de frío / accumulateur de froid

| | | |
|---------|---------|-----|
| 10779 3 | 25 x 19 | 2,5 |
|---------|---------|-----|



11541



11010

11010

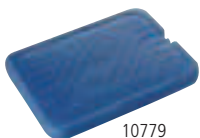

10779

Kühl-Akkus halten
Ihre Speisen bis
zu 6 Stunden kühl

Kühltablett Buffet-Vitrine „DOPPELDECKER“ Cooling buffet display expositor buffet frío vitrine buffet



12-teilig: 2 Kästen Buchen-Holz versiegelt + 2 Tablett GN1/1 + 4 Kühlakkus + 4 Stangen, ohne Hauben

14 pcs. set: 2 beech wood boxes waterproof + 2 trays GN1/1 + 4 coolers + 4 fittings, without covers

Set 14 pzs. 2 bases madera tratada + 2 bandejas inox GN1/1 + 4 enfriadores + 4 pies (campanas no incl.)

Set 14 éléments: 2 caissons bois traité (hêtre), 2 plateaux inox GN 1/1 cm, 4 accus, 4 pieds (cloches non incluses)

| | cm | cm |
|---------|---------|----|
| 11541 5 | 60 x 41 | 36 |

verchromte Stäbe
chrome plated fittings
pies cromados
pieds chromés

passendes Zubehör / suitable accessories / accesorios a juego / accessoires assortis

Rolltop-Haube GN1/1, vergoldeter Griff / rolltop cover, gold plated handle
campana rolltop, pomo dorado / cloche rolltop, bouton doré

| | | |
|---------|-----------|----|
| 11008 3 | 53 x 32,5 | 17 |
|---------|-----------|----|

Rolltop-Haube GN1/1, verchromter Griff / rolltop cover, chrome plated handle
campana rolltop, pomo cromado / cloche rolltop, bouton chromé

| | | |
|---------|-----------|----|
| 11010 6 | 53 x 32,5 | 17 |
|---------|-----------|----|

Kühlakku / cooler / acumulador de frío / accumulateur de froid

| | | |
|---------|---------|-----|
| 10779 3 | 25 x 19 | 2,5 |
|---------|---------|-----|



Buche (wasserfest lackiert)

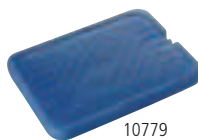

Kühl-Akkus halten
Ihre Speisen bis
zu 6 Stunden kühl

Kühltablett „TOP FRESH RUND“
Refrigerated buffet display
expositor buffet frío redondo
présentoir buffet



3-teilig: 1 Holzbox mit Kunststoffwanne + 1 Edelstahl-Tablett Ø 38 cm + 1 Kühlakku
3 pcs. set: 1 woodbox with plastic insert + 1 stainless tray Ø 38 cm + 1 cooler
3 pzs, caja madera, bandeja inox Ø 38 cm, acumulador de frío
3 pc, base bois, plateau inox Ø 38 cm, accumulateur de froid

| | □ cm | ↑ cm |
|---------|------|------|
| 11542 2 | Ø 48 | 6 |

passendes Zubehör / suitable accessories / accesorios a juego / accessoires assortis

Rolltop-Haube mit verchromtem Kugelgriff / rolltop cover chrome plated handle
campana abatible pomo cromado / cloche basculante bouton chromé

| | | |
|---------|------|----|
| 18388 9 | Ø 38 | 20 |
|---------|------|----|

Rolltop-Haube mit vergoldetem Kugelgriff / rolltop cover gold plated handle
campana abatible pomo dorado / cloche basculante bouton doré

| | | |
|---------|------|----|
| 18387 2 | Ø 38 | 20 |
|---------|------|----|

Kühlakku / cooler / acumulador de frío / accumulateur de froid

| | | |
|---------|---------|-----|
| 10779 3 | 25 x 19 | 2,5 |
|---------|---------|-----|

Buffet . Banquet
buffet . banquet



11543

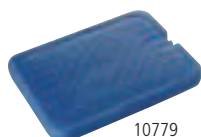

Kühl-Akkus halten
Ihre Speisen bis
zu 6 Stunden kühl

Kühltablett Buffet-Vitrine „DOPPELDECKER“
Double refrigerated buffet display
expositor de bufet redondo doble
présentoir buffet froid, double



11-teilig: 2 Rahmen Buchen-Holz versiegelt + 2 Edelstahl-Tablets Ø 38 cm
+ 2 Kühlakkus + 2 Kunststoffschalen + 3 Stangen, ohne Hauben

11 pcs. set: 2 beech wood boxes waterproof + 2 stainless trays Ø 38 cm + 2 cooler + 2 plastic deep trays + 3 fittings, without covers

Set 11 piezas 2 bases madera, 2 bandejas inox aprox. 38cm, 2 acumuladores, 2 cubetas plásticas, 3 pies, (campanas no incl.)

Set 11 éléments: 2 caissons bois traité (hêtre), 2 plateaux inox approx. 38 cm, 2 accus, 2 bacs plastique, 3 pieds (cloches non incluses)

| | □ cm | ↑ cm | |
|---------|------|------|---|
| 11543 9 | Ø 48 | 38 | verchromte Stäbe gold plated fittings pies dorados pieds dorés |

passendes Zubehör / suitable accessories / accesorios a juego / accessoires assortis

Rolltop-Haube mit verchromtem Kugelgriff / rolltop cover chrome plated handle
campana abatible pomo cromado / cloche basculante bouton chromé

| | | |
|---------|------|----|
| 18388 9 | Ø 38 | 20 |
|---------|------|----|

Rolltop-Haube mit vergoldetem Kugelgriff / rolltop cover gold plated handle
campana abatible pomo dorado / cloche basculante bouton doré

| | | |
|---------|------|----|
| 18387 2 | Ø 38 | 20 |
|---------|------|----|

Kühlakku / cooler / acumulador de frío / accumulateur de froid

| | | |
|---------|---------|-----|
| 10779 3 | 25 x 19 | 2,5 |
|---------|---------|-----|

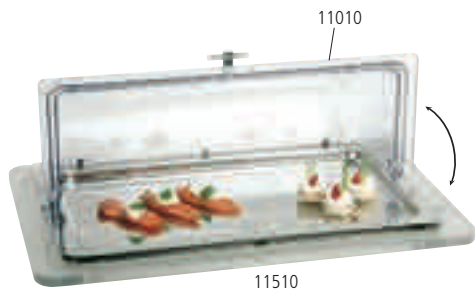

Kühltablett Buffet-Vitrine „TOP FRESH GN1/1“
Cooling buffet display
expositor buffet frío
Présentoir buffet



5-teilig: 1 Edelstahl-Tablett GN1/1 + 2 Kühlakkus + 1 Edelstahl-Schale + 1 Acrylrahmen, ohne Haube

5 pcs. set: 1 stainless tray GN1/1 + 2 cooler + 1 stainless deep tray + 1 frame acrylic, without cover

Set 5 pzs : 1 bandeja inox, 2 acumuladores, 1 cubeta inox, 1 marco metacrilato (campana no incl.)

Set 5 pc : 1 plateau inox, 2 accus. de froid, 1 bac inox, 1 cadre plexi (cloche non-incl.)

| | cm | cm |
|---------|---------|----|
| 11510 1 | 61 x 38 | 26 |



passendes Zubehör / suitable accessories / accesorios a juego / accessoires assortis

Rolltop-Haube GN1/1, verchromter Griff / rolltop cover, chrome plated handle
 campana rolltop, pomo cromado / cloche rolltop, bouton chromé

| | | |
|---------|-------------|----|
| 11010 6 | 53,0 x 32,5 | 19 |
|---------|-------------|----|

Kühlakku / cooler / acumulador de frío / accumulateur de froid

| | | |
|---------|---------|-----|
| 10779 3 | 25 x 19 | 2,5 |
|---------|---------|-----|

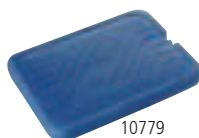

**Kühl-Akkus halten
Ihre Speisen bis
zu 6 Stunden kühl**

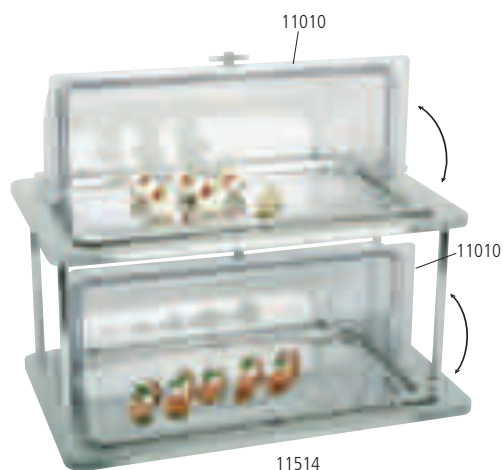

Kühltablett Buffet-Vitrine „DOPPELDECKER“
cooling plate
expositor buffet frío
présentoir buffet



14-teilig: 2 Edelstahl-Tabletts GN1/1 + 4 Kühlakkus + 2 Edelstahl-Schale + 2 Acrylrahmen + 4 verchromte Stangen, ohne Hauben

14 pcs. set: 2 stainless tray GN1/1 + 4 cooler + 2 stainless deep trays + 2 frames acrylic + 4 chrome plated fittings, without covers

Set 14 pzs 2 bandejas inox GN 1/1, 4 acum. de frío 2 cubetas inox, 2 bases metacrilato, 4 pies cromados (sin las campanas)

Set 14 pc 2 plateaux inox GN 1/1, 4 accus 2 bacs inox, 2 cadres plexi, 4 pieds chromés (sans les cloches)

| | cm | cm |
|---------|---------|----|
| 11514 9 | 61 x 38 | 52 |

passendes Zubehör / suitable accessories / accesorios a juego / accessoires assortis

Rolltop-Haube GN1/1, verchromter Griff / rolltop cover, chrome plated handle
 campana rolltop, pomo cromado / cloche rolltop, bouton chromé

| | | |
|---------|-------------|----|
| 11010 6 | 53,0 x 32,5 | 19 |
|---------|-------------|----|

Kühlakku / cooler / acumulador de frío / accumulateur de froid

| | | |
|---------|---------|-----|
| 10779 3 | 25 x 19 | 2,5 |
|---------|---------|-----|

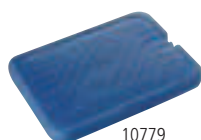

**Kühl-Akkus halten
Ihre Speisen bis
zu 6 Stunden kühl**



Kühltablett „TOP FRESH RUND“
cooling plate
expositor buffet frío
présentoir buffet



4-teilig: 1 Edelstahl-Tablett Ø 38 cm + 2 Kühlakkus + 1 Edelstahl-Schale + 1 Acrylrahmen, ohne Haube

4 pcs. set: 1 stainless tray Ø 38 cm + 2 cooler + 1 stainless deep tray + 1 frame acrylic, without cover

Set 4 pz 1 bandeja inox 38cm, 2 acum. de frío, 1 cubeta inox, 1 base metacrilato (campana no incluida)

Set 4 pc 1 plateau inox 38cm, 2 accum. de froid, 1 bac inox, 1 base plexi (cloche non incl.)

| | □ cm | ↑ cm |
|---------|--------|------|
| 11512 5 | Ø 43,5 | 26 |

passendes Zubehör / suitable accessories / accesorios a juego / accessoires assortis

Rolltop-Haube mit verchromtem Griff / rolltop cover chrome plated handle
campana abatible pomo cromado / cloche basculante bouton chromé

| | | |
|---------|------|----|
| 18388 9 | Ø 38 | 20 |
|---------|------|----|

Kühlakku / cooler / acumulador de frío / accumulateur de froid

| | | | |
|---------|----------|-----|--------|
| 11101 1 | 16 x 7,5 | 2,0 | 4 pcs. |
|---------|----------|-----|--------|

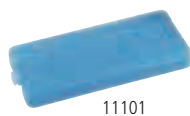

Kühl-Akku hält
Ihre Speisen bis
zu 6 Stunden kühl

11101



Kühltablett Top Fresh „DOPPELDECKER“
cooling plate
expositor de bufet doble redondo
présentoir buffet



11-teilig: 2 Edelstahl-Tablets Ø 38 cm + 4 Kühlakkus + 2 Edelstahl-Schalen + 2 Acrylrahmen + 3 verchromte Stangen, ohne Hauben

13 pcs. set: 2 stainless trays Ø 38 cm + 4 cooler + 2 stainless deep tray + 2 frames acrylic + 3 chrome plated fittings, without covers

Set 13 pz: 2 bandejas inox 38 cm, 4 acumuladores de frío, 3 pies cromados, 2 bases, 2 bandejas, campana no incluida.

Set 13 pc 2 plateaux inox 38cm, 4 accum. de froid, 2 bacs inox, 2 bases plexi, 3 pieds chromés (cloche non incl.)

| | □ cm | ↑ cm |
|---------|-----------|------|
| 11516 3 | 33 x 19,5 | 8 |

passendes Zubehör / suitable accessories / accesorios a juego / accessoires assortis

Rolltop-Haube mit verchromtem Griff / rolltop cover chrome plated handle
campana abatible pomo cromado / cloche basculante bouton chromé

| | | |
|---------|------|----|
| 18388 9 | Ø 38 | 20 |
|---------|------|----|

Kühlakku / cooler / acumulador de frío / accumulateur de froid

| | | | |
|---------|----------|-----|--------|
| 11101 1 | 16 x 7,5 | 2,0 | 4 pcs. |
|---------|----------|-----|--------|



Kühl-Akkus halten
Ihre Speisen bis
zu 6 Stunden kühl

11101



Set, 4-teilig,
weiß-transparent
11503



Set schwarz,
4-teilig 11505



separates Zubehör:
Tablett
11100

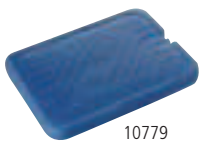

Kühl-Akkus halten
Ihre Speisen bis
zu 6 Stunden kühl

10779

Kühlbox „TOP FRESH GN1/1“ cooling plate bandeja de frío Présentoir buffet réfrigéré



4-teilig: 1 Kühlbox + 1 Tablett GN1/1 + 2 Kühlakkus, ohne Haube

4 pcs. set: 1 box + 1 tray GN1/1 + 2 coolers, without cover

Set de 4 pcs: 1 caja plástico blanco, 1 bandeja GN 1/1, 2 acum. de frío, campana no incluida

Set de 4 pc: 1 caisson plastique blanc, 1 plateau GN 1/1, 2 accum. de froid (cloche non incl.)

| | □ cm | ↑ cm | |
|---------|-----------|------|---|
| 11503 3 | 56,5 x 35 | 6,5 | ○ |
| 11505 7 | 56,5 x 35 | 6,5 | ● |

passendes Zubehör / suitable accessories accesorios a juego / accessoires assortis



Rolltop-Haube GN1/1, vergoldeter Griff / rolltop cover, gold plated handle
campana rolltop, pomo dorado / cloche rolltop, bouton doré

| | | |
|---------|-----------|----|
| 11008 3 | 53 x 32,5 | 19 |
|---------|-----------|----|

Rolltop-Haube GN1/1, verchromter Griff / rolltop cover, chrome plated handle
campana rolltop, pomo cromado / cloche rolltop, bouton chromé

| | | |
|---------|-------------|----|
| 11010 6 | 53,0 x 32,5 | 19 |
|---------|-------------|----|

Kühlakku / cooler / acumulador de frío / accumulateur de froid

| | | |
|---------|---------|-----|
| 10779 3 | 25 x 19 | 2,5 |
|---------|---------|-----|

In der Box sorgt der Kühlakku für eine
beständige Frische für Wurst, Käse, etc.

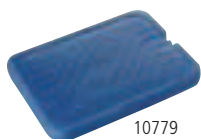
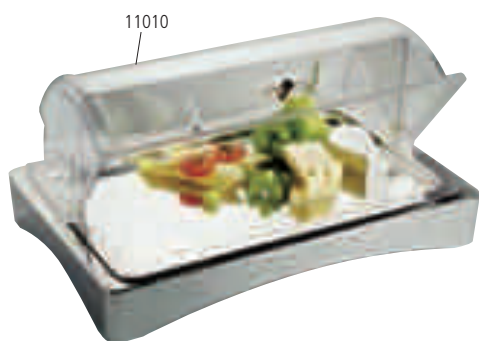

Kühl-Akku hält
Ihre Speisen bis
zu 6 Stunden kühl

10779

Kühlbox „TOP FRESH“ cooling box expositor buffet frío Présentoir buffet



3-teilig: 1 Kühlbox + Tablett GN1/1 + 2 Kühlakkus, ohne Haube

3 pcs. set: 1 box + 1 tray GN1/1 + 2 cooler, without rolltop cover

Set 3 piezas, cajón, bandeja GN 1/1, 2 enfriadores, campana no incluida

Set 3 pc, caisson inférieur, plateau GN 1/1, 2 accus, cloche non incluse

| | □ cm | ↑ cm |
|---------|-----------|------|
| 11590 3 | 56,5 x 36 | 8,5 |

passendes Zubehör / suitable accessories / accesorios a juego / accessoires assortis

Rolltop-Haube GN1/1, vergoldeter Griff / rolltop cover, gold plated handle
campana rolltop, pomo dorado / cloche rolltop, bouton doré

| | | |
|---------|-----------|----|
| 11008 3 | 53 x 32,5 | 19 |
|---------|-----------|----|

Rolltop-Haube GN1/1, verchromter Griff / rolltop cover, chrome plated handle
campana rolltop, pomo cromado / cloche rolltop, bouton chromé

| | | |
|---------|-------------|----|
| 11010 6 | 53,0 x 32,5 | 19 |
|---------|-------------|----|

Schneidbrett / chopping board / tabla de corte / planche à découper

| | | |
|---------|-------------|---|
| 00901 1 | 47,5 x 26,5 | 1 |
|---------|-------------|---|

Kühlakku / cooler / acumulador de frío / accumulateur de froid

| | | |
|---------|---------|-----|
| 10779 3 | 25 x 19 | 2,5 |
|---------|---------|-----|



weiß-
transparent
oder schwarz

**Kühlbox „TOP FRESH SET“
cooling plate
bandeja de frío
set réfrigère**



3-teilig: 1 Box + 1 Tablett Ø 38 cm + 1 Kühlakku, ohne Haube
3 pcs. set: 1 box + 1 tray Ø 38 cm + 1 cooler, without cover
Set de 3 piezas: 1 caja, 1 bandeja Ø 38 cm + 1 enfriador, sin tapa
Set de 3 pc: 1 caisson, 1 plateau Ø 38 cm + 1 accum. (livré sans la cloche)

| | ☐ cm | ↑ cm | | |
|---------|------|------|---|------------------|
| 11538 5 | Ø 42 | 6 | ○ | weiß white |
| 11533 0 | Ø 42 | 6 | ● | schwarz black |

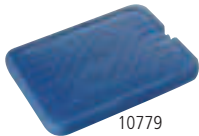

Kühl-Akku hält
Ihre Speisen bis
zu 6 Stunden kühl

**passendes Zubehör / suitable accessories
accesorios a juego / accessoires assortis**



Rolltop-Haube mit verchromtem Kugelgriff / rolltop cover chrome plated handle
campana abatible pomo cromado / cloche basculante bouton chromé

| | | | | |
|---------|------|----|--|--|
| 18388 9 | Ø 38 | 20 | | |
|---------|------|----|--|--|



**Thermo-Set
thermo-set
bandeja isotérmica
set thermo**



5-teilig: 1 Tablett tief + 1 Tablett flach + 2 Kühlakkus + 1 Rolltop-Haube
5 pcs. set: 1 deep tray + 1 tray + 2 cooler + 1 rolltop cover
Set de 5 piezas: 1 bandeja inferior + 1bandeja + 2 acumuladores frío + campana.
set 5 pc: 1 plateau creux + 1 plateau plat + 2 accum. + 1 cloche rolltop

| | ☐ cm | ↑ cm | | |
|---------|------|------|--|--|
| 09082 8 | Ø 38 | 24 | | |

**passendes Zubehör / suitable accessories
accesorios a juego / accessoires assortis**



Rolltop-Haube mit verchromtem Kugelgriff / rolltop cover chrome plated handle
campana abatible pomo cromado / cloche basculante bouton chromé

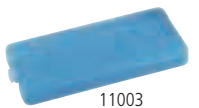

Kühl-Akkus halten
Ihre Speisen bis
zu 6 Stunden kühl

| | | | | |
|---------|------|----|--|--|
| 18388 9 | Ø 38 | 20 | | |
|---------|------|----|--|--|



**Thermo-Set
thermo-set
porta tartas refrigerado
porte-gâteau réfrigéré**



4-teilig: 1 Tablett tief auf Fuß + 1 Tablett flach + 2 Kühlakkus
4 pcs. set: 1 deep tray with feet + 1 tray + 2 cooler
Set de 4 piezas: -1 bandeja honda con pie, bandeja+ 2 acumuladores de frío con pie.
set de 4 pc : 1 plateau creux avec pied + 1 plateau plat + 2 accum.

| | ☐ cm | ↑ cm | | |
|---------|------|------|--|--|
| 09083 5 | Ø 38 | 14,5 | | |

**passendes Zubehör / suitable accessories
accesorios a juego / accessoires assortis**



Rolltop-Haube mit verchromtem Kugelgriff / rolltop cover chrome plated handle
campana abatible pomo cromado / cloche basculante bouton chromé

| | | | | |
|---------|------|----|--|--|
| 18388 9 | Ø 38 | 20 | | |
|---------|------|----|--|--|

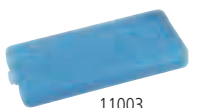

Kühl-Akkus halten
Ihre Speisen bis
zu 6 Stunden kühl



Kühlschale, 2-teilig „COOL“
cool bowl, 2 pcs. set
bol refrigerado, 2 pz.
set de 2 bols réfrigérés



2-teilig, doppelwandig, Schale ist mit Kühlmittel gefüllt und wird zum Aufladen in das Gefrierfach gelegt, endlos verwendbar

2 pcs., 1 pc. double wall ice bowl filled with freezer-liquid, 1 pc. stainless bowl

bol isotérmico doble pared que contiene un líquido refrigerante, a acumula el frío en el congelador para luego mantener fríos los alimentos, para usos repetitivos

bol isotherme double paroi qui contient un liquide réfrigérant, a cumule le froid du congélateur pour ensuite maintenir froids les aliments, pour usages répétés



| | □ cm | ↑ cm | ltr. |
|---------|------|------|------|
| 30023 1 | Ø 23 | 10,5 | 1 |



Einzelteile / spare parts / piezas sueltas / pièces détachées

Deckel, SAN mit Löffelaussparung / cover, SAN / tapa, SAN / couvercle, SAN

| | | | |
|---------|--------|-----|--|
| 83920 5 | Ø 20,5 | 1,3 | |
|---------|--------|-----|--|



passender Deckel
83920

Kühldauer bis
zu 3 Stunden

Kühlschale Maxi Holz „TOP FRESH“
cool maxi holz
bol refrigerado MAXI madera
bol réfrigéré MAXI bois



11817
2,5 ltr.

4-teilig: 1 Fuß Buchen-Holz versiegelt + 1 Schale + 1 Kühlakku + 1 klappbarer Deckel mit Beschriftungsschild

4 pcs. set: 1 column with food base (beech) + 1 bowl + 1 cooler + 1 cover with card, hinged
 set de 4 piezas: 1 bol, 1 base madera, 1 acumulador de frío, 1 tapa con bisagra y porta etiqueta

set de 4 pc : 1 base en bois, 1 accum.. 1 bol, 1 couvercle à charnière avec porte-étiquette

| | □ cm | ↑ cm | ltr. |
|---------|------|------|------|
| 11817 1 | Ø 22 | 14 | 2,5 |
| 11818 8 | Ø 22 | 18 | 4 |

Einzelteile / spare parts / piezas sueltas / pièces détachées

Ersatzschale für 11817 / spare bowl for 11817

recambio bol para 11817 / bol de rechange para 11817

| | | | |
|---------|------|---|--|
| 11846 1 | Ø 22 | 8 | |
|---------|------|---|--|

Ersatzschale für 11818 / spare bowl for 11818

recambio bol para 11818 / bol de rechange para 11818

| | | | |
|---------|------|----|--|
| 11848 5 | Ø 22 | 12 | |
|---------|------|----|--|

Ersatzdeckel für 11817 + 11818 / replacement cover for 11817 + 11818

tapa de recambio para 11817 + 11818 / couvercle de rechange para 11817 + 11818

| | | | |
|---------|--------|--|--|
| 11878 2 | Ø 23,5 | | |
|---------|--------|--|--|

Kühlakku / cooler / acumulador de frío / accumulateur de froid

| | | | |
|---------|------|-----|--|
| 10777 9 | Ø 15 | 2,5 | |
|---------|------|-----|--|



11818
4 ltr.



Kühl-Akku hält
Ihre Speisen bis
zu 6 Stunden kühl

10777



11810
0,6 ltr.



11815
1 ltr.



Kühl-Akku hält
Ihre Speisen bis
zu 6 Stunden kühl

Kühlschale Mini „TOP FRESH“
cool bowl mini
bol refrigerado MINI
bol réfrigéré MINI



4-teilig: 1 Edelstahlgefäß matt + 1 Kühlakku + 1 Schale + 1 klappbarer Deckel mit Beschriftungsschild

4 pcs. set: 1 column satin polished finish + 1 cooler + 1 bowl + 1 cover with card, hinged

Set 4 piezas: 1 base acabado efecto satinado, 1 acumulador de frío, 1 tapa con porta etiqueta, 1 bol

Set 4 pc: 1 base inox mat satiné, 1 accum. de froid, 1 couvercle à charnière avec porte étiquette, 1 bol

| | □ cm | ↑ cm | ltr. |
|---------|------|------|------|
| 11810 2 | Ø 14 | 9 | 0,6 |
| 11815 7 | Ø 14 | 11,5 | 1 |

Einzelteile / spare parts / piezas sueltas / pièces détachées

Ersatzschale / spare bowl / Recambio bol / bol de rechange

| | | |
|---------|------|-----|
| 11811 9 | Ø 14 | 6,5 |
| 11816 4 | Ø 14 | 9 |

Ersatzdeckel für 11810 + 11815 / replacement cover for 11810 + 11815

tapa de recambio para 11810 + 11815 / couvercle de rechange para 11810 + 11815

| | |
|---------|--------|
| 11868 3 | Ø 14,5 |
|---------|--------|

Kühlakku / cooler / acumulador de frío / accumulateur de froid

| | | |
|---------|--------|-----|
| 10661 1 | Ø 10,5 | 2,0 |
|---------|--------|-----|



11812
0,6 ltr.



11813
1 ltr.



Kühl-Akku hält
Ihre Speisen bis
zu 6 Stunden kühl

Kühlschale Mini Holz „TOP FRESH“
cool bowl mini holz
bol refrigerado mini madera
bol réfrigéré MINI bois



4-teilig: 1 Fuß Buchen-Holz versiegelt + 1 Schale + 1 Kühlakku + 1 klappbarer Deckel mit Beschriftungsschild

4 pcs. set: 1 column with food base (beech) + 1 bowl + 1 cooler + 1 cover with card, hinged

Set de 4 pzs: 1 bol policarbonato, 1 base madera, 1 acum. de frío, 1 tapa con bisagra y porta etiqueta.

set de 4 pc : 1 base en bois, 1 accum. 1 bol polycarbonate, 1 couvercle à charnière avec porte-étiquette

| | □ cm | ↑ cm | ltr. |
|---------|------|------|------|
| 11812 6 | Ø 14 | 9 | 0,6 |
| 11813 3 | Ø 14 | 11,5 | 1 |

Einzelteile / spare parts / piezas sueltas / pièces détachées

Ersatzschale / spare bowl / Recambio bol / bol de rechange

| | | |
|---------|------|-----|
| 11811 9 | Ø 14 | 6,5 |
| 11816 4 | Ø 14 | 9 |

Ersatzdeckel für 11812 + 11813 / replacement cover for 11812 + 11813

tapa de recambio para 11812 + 11813 / couvercle de rechange para 11812 + 11813

| | |
|---------|--------|
| 11868 3 | Ø 14,5 |
|---------|--------|

Kühlakku / cooler / acumulador de frío / accumulateur de froid

| | | |
|---------|--------|-----|
| 10661 1 | Ø 10,5 | 2,0 |
|---------|--------|-----|

10661



2,5 ltr.

Kühlschale Maxi „TOP FRESH“
cool bowl maxi
bol refrigerado MAXI
bol réfrigéré MAXI



4-teilig: 1 Gefäß hochglanzpoliert + 1 Kühlakku + 1 Glasschale + 1 klappbarer Deckel mit Beschriftungsschild

4 pcs. set: 1 column mirror polished finish + 1 cooler + 1 glass bowl + 1 cover with card, hinged

Set de 4 piezas: 1 base pulido acabado efecto espejo, 1 acumulador de frío, 1 tapa con porta etiqueta, 1 bol vidrio

set de 4 pc : 1 base inox poli brillant, 1 accum. 1 bol verre, 1 couvercle à charnière avec porte-étiquette

| | ☐ cm | ↑ cm | ltr. |
|---------|------|------|------|
| 11845 4 | Ø 23 | 14 | 2,5 |

Ersatzdeckel / replacement cover
 tapa de recambio / couvercle de rechange

| | | | |
|---------|--------|--|--|
| 11878 2 | Ø 23,5 | | |
|---------|--------|--|--|

Schale / bowl / bol / bol

| | | | |
|---------|------|------|--|
| 11875 1 | Ø 23 | 10,5 | |
|---------|------|------|--|

Kühlakku / cooler / acumulador de frío / accumulateur de froid

| | | | |
|---------|------|-----|--|
| 10777 9 | Ø 15 | 2,5 | |
|---------|------|-----|--|



Kühl-Akku hält
Ihre Speisen bis
zu 6 Stunden kühl

10777



11847
2,5 ltr.

Kühlschale Maxi „TOP FRESH“
cool bowl maxi
bol refrigerado MAXI
bol réfrigéré MAXI



4-teilig: 1 Gefäß hochglanzpoliert + 1 Kühlakku + 1 Schale + 1 klappbarer Deckel mit Beschriftungsschild

4 pcs. set: 1 column mirror polished finish + 1 cooler + 1 bowl + 1 cover with card, hinged

Set de 4 piezas: 1 base pulido acabado efecto espejo, 1 acumulador de frío, 1 tapa con porta etiqueta, 1 bol

set de 4 pc : 1 base inox poli brillant, 1 accum. 1 récipient, 1 couvercle à charnière avec porte-étiquette

| | ☐ cm | ↑ cm | ltr. |
|---------|------|------|------|
| 11847 8 | Ø 22 | 14 | 2,5 |
| 11849 2 | Ø 22 | 18 | 4 |

Einzelteile / spare parts / piezas sueltas / pièces détachées

Ersatzschale / spare bowl / recambio bol / bol de rechange

| | | | |
|---------|------|----|--|
| 11846 1 | Ø 22 | 8 | |
| 11848 5 | Ø 22 | 12 | |

Ersatzdeckel für 11847 + 11849 / replacement cover for 11847 + 11849
 tapa de recambio para 11847 + 11849 / couvercle de rechange para 11847 + 11849

| | | | |
|---------|--------|--|--|
| 11878 2 | Ø 23,5 | | |
|---------|--------|--|--|

Kühlakku / cooler / acumulador de frío / accumulateur de froid

| | | | |
|---------|------|-----|--|
| 10777 9 | Ø 15 | 2,5 | |
|---------|------|-----|--|



11849
4 ltr.



Kühl-Akku hält
Ihre Speisen bis
zu 6 Stunden kühl

10777

Serviergestell
servicing stand
expositor
présentoir



| | □ cm | ↑ cm | cm |
|---------|------|------|----------|
| 33244 7 | Ø 35 | 46 | 4 x Ø 14 |
| 33245 4 | Ø 48 | 49 | 4 x Ø 20 |
| 33246 1 | Ø 22 | 59 | 12 x Ø 6 |
| 33247 8 | Ø 22 | 33 | 6 x Ø 6 |



Gestell
12 x Ø 6 cm
33246

passend für 12 Weck-Gläser Ø 6 cm
 Nr. 82310, 82312, 82314

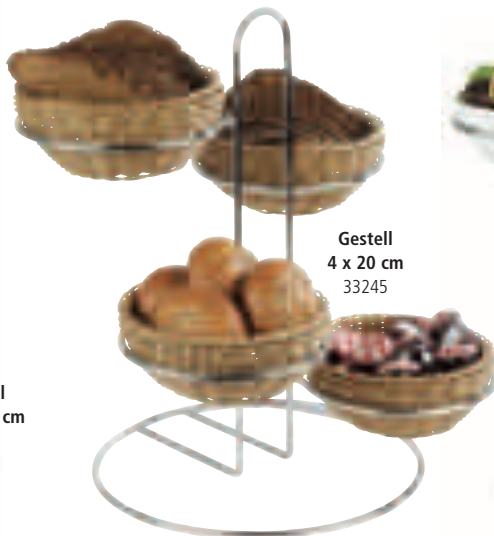

Gestell
4 x 20 cm
33245

passend für Schalen Ø 20 cm Nr. 83704, 83705
 und für Körbe Ø 20 cm Nr. 50605, 50606, 50607



Gestell
4 x 20 cm
33244

passend für Schalen Ø 14 cm
 Nr. 83700, 83701



Gestell
6 x 6 cm
33247

passend für 6 Weck-Gläser Ø 6 cm
 Nr. 82310, 82312, 82314

Buffet . Banquet
 buffet . banquet



Buffet-Gestell für Körbe
buffet stand for baskets
expositor para cestas
support métal pour corbeilles

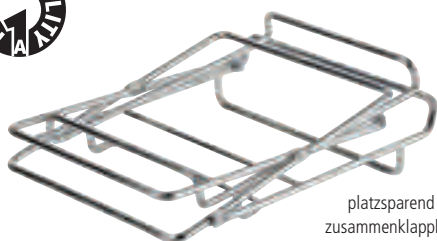

platzsparend
 zusammenklappbar

2-stufig, für 2 rechteckige Körbe, platzsparend zusammenklappbar, Lieferung ohne Körbe
 2-tier, for 2 rectangular baskets, can be folded, place saving, delivery without baskets
 2 alturas, para 2 cestas rectangulares, totalmente plegable para ahorrar espacio. Se sirve sin cestas
 2 hauteurs, pour 2 corbeilles rectangulaires. Pliable pour son rangement. Livré sans corbeilles.

Korb
 40222



| | □ cm | ↑ cm |
|---------|---------|---------|
| 33221 8 | 46 x 24 | 18 - 21 |

Einzelteile / spare parts / piezas sueltas / pièces détachées

Tisch- und Buffet-Korb rechteckig „BASIC“ / buffet basket / cesta de bufet / corbeille de buffet

| | | | |
|---------|-------------|-----|---|
| 30286 0 | 30,0 x 22,0 | 7 | ● |
| 30288 4 | 41,0 x 29,0 | 7 | ● |
| 40154 9 | 30,0 x 24,5 | 8 | ● |
| 40159 4 | 31,5 x 22,0 | 8,5 | ● |
| 40161 7 | 50,0 x 25,0 | 6 | ● |
| 40222 5 | 32,5 x 26,5 | 6,5 | ● |
| 40242 3 | 32,5 x 26,5 | 10 | ● |
| 40262 1 | 32,5 x 26,5 | 6,5 | ● |
| 40272 0 | 32,5 x 26,5 | 10 | ● |

Korb
 40262



EAN = 40 04 133 XXXX X



Buffet-Gestell „DOPPELDECKER“

buffet frame
estructura para buffet
support buffet



für GN, 2-teilig, einfach zusammensetzbar, Etagen-Abstand ca. 26 cm, platzsparend, stabile Ausführung

for GN, 2 pcs. frame, easy to assemble, distance between the tiers approx 26 cm, space-saving, robust

para bandejas GN, fácil de montar, distancia entre pisos aprox. 26 cm, robusto

pour corbeilles ou plats GN, 2 étages, distance entre niveaux approx. 26 cm, robuste



in 2 Größen erhältlich und
vielseitig erweiterbar

Buffet-Gestell GN 1/1
11555

Buffet-Gestell GN 1/2
11553

| | □ cm | ↑ cm | GN |
|---------|---------|------|-----|
| 11555 2 | 50 x 34 | 37,5 | 1/1 |
| 11553 8 | 29 x 27 | 35 | 1/2 |

Einzelteile / spare parts / piezas sueltas / pièces détachées

Buffet-Korb / buffet basket / cestas buffet / paniers buffet

| | | | | |
|---------|-------------|-----|-----|---|
| 40148 8 | 53 x 32,5 | 8 | 1/1 | ● |
| 40154 9 | 30,0 x 24,5 | 8,0 | | ● |

Edelstahl-Tablett „PROFI LINE“ / tray / bandeja / plat empilable système catering

| | | | |
|---------|-----------|-----|-----|
| 11100 4 | 53 x 32,5 | 1,5 | 1/1 |
|---------|-----------|-----|-----|

Abdeckhaube GN / cover GN / cubierta GN / cloche GN

| | | | |
|---------|-------------|-----|-----|
| 11001 4 | 32,5 x 26,5 | 9,5 | 1/2 |
| 11008 3 | 53 x 32,5 | 19 | 1/1 |
| 11010 6 | 53,0 x 32,5 | 19 | 1/1 |

Kuppelhaube für GN1/1, glasklarer Kunststoff, Chromgriff, geschlossen

cover, clear, chrome knob, totally closed

cúpula, transparente, asa cromada, cerrada

cloche bombée, transparente, anse chromée, totalement fermée

| | | |
|---------|---------|----|
| 11015 1 | 54 x 33 | 20 |
|---------|---------|----|

Kuppelhaube für GN1/1, glasklarer Kunststoff, Chromgriff, mit Front-Ausschnitt

cover, clear, chrome knob, one long side cut out

cúpula, transparente, asa cromada, gran apertura frontal

cloche bombée, transparente, anse chromée, grande ouverture frontale

| | | |
|---------|---------|----|
| 11017 5 | 54 x 33 | 20 |
|---------|---------|----|

Kuppelhaube für GN1/1, glasklarer Kunststoff, Chromgriff, mit seidl. Ausschnitt

cover, clear, chrome knob, one small side cut out

cúpula, transparente, asa cromada, pequeña apertura frontal

cloche bombée, transparente, anse chromée, petite ouverture frontale

| | | |
|---------|---------|----|
| 11019 9 | 54 x 33 | 20 |
|---------|---------|----|

GN 1/2



Korb
40154

Haube GN 1/1
11017



Tablett GN 1/1
11100

GN 1/1

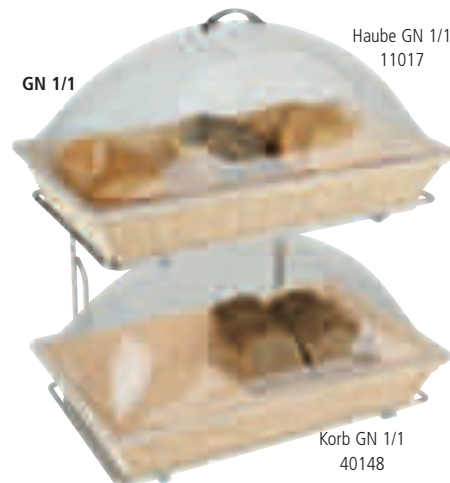

Haube GN 1/1
11017

Korb GN 1/1
40148

BROTSTATION



Box
00954

Schneidebrett
00953

Tablett
83615

Buffet. Banquet
buffet. banquet



Antirutsch-Füßchen

Tablett „BROTSTATION“
tray „BREAD BUFFET“
bandeja „BREAD BUFFET“
plateau „PAIN ET BUFFET“



Antirutsch-Füßchen
Non-slip feet
pies antideslizantes
pieds anti-glisse

| | cm | cm |
|---------|-------------|-----|
| 83615 0 | 59,5 x 35,5 | 3,5 |

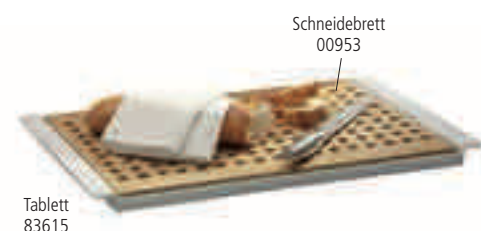

Schneidebrett
00953

Tablett
83615

Brotschneidebrett „BROTSTATION“
cutting board „BREAD BUFFET“
tabla de corte „BREAD BUFFET“
planche a decouper „PAIN ET BUFFET“



Buchen-Holz
beech
haya
hêtre

| | cm | cm |
|---------|---------|----|
| 00953 0 | 52 x 34 | 2 |

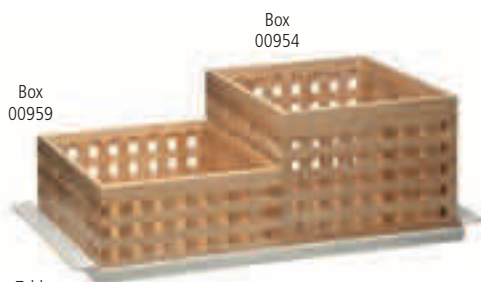

Box
00954

Box
00959

Tablett
83615

Box „BROTSTATION“
box „BREAD BUFFET“
caja de pan para el bufet
boîte à pain pour le buffet



Buchen-Holz
beech
haya
hêtre

| | cm | cm |
|---------|---------|------|
| 00959 2 | 34 x 26 | 12,5 |
| 00954 7 | 34 x 26 | 20,0 |



**Hygieneschutz
hygienic cover
cubierta higiénica antialiento
pare-haleine**



| | cm | cm |
|---------|---------|----|
| 11556 9 | 82 x 42 | 45 |

**Brotschneidebrett, 2-tlg.
cutting board, 2 pcs.
tabla para cortar 2 piezas
planche à découper 2 pièces**



2-tlg. Set, GN1/1 Behälter, 20 mm tief, dient als Krümfach
2 pcs. set, GN1/1 pan 20 mm, bread crump shelf
set 2 piezas, : tabla de corte + bandeja inox GN 1/1 alt 20 mm (sirve para recoger las migas)
set 2 pc : planche à découper bois + plateau inox GN 1/1 Ht 20 mm (sert de ramasse-miettes)

| | cm | GN |
|---------|-----------|-----|
| 00951 6 | 53 x 32,5 | 1/1 |

Einzelteile / spare parts / piezas sueltas / pièces détachées

einzelnes Brett / separate board / Tabla por separado / plache seule

| | | |
|---------|-----------|-----|
| 00952 3 | 53 x 32,5 | 1/1 |
|---------|-----------|-----|

**Brotschneidebrett
cutting board
tabla para cortar
planche à découper**



mit herausnehmbarem Krümfach, auf 4 Antirutschfüßchen
with bread crump shelf, anti slip-feet
tabla para cortar pan, madera tratada anti-deslizante.
planche à pain, bois traité anti-dérapant

| | cm | cm | GN |
|---------|-----------|----|-----|
| 00955 4 | 47,5 x 32 | 2 | |
| 00956 1 | 53 x 32,5 | 2 | 1/1 |
| 00957 8 | 60 x 40 | 2 | |

**Brotschneidebrett, 2-tlg.
satin polished finish, cutting board, 2pcs.
tabla para cortar pan, 2 piezas, laterales mates
planche à découper 2 pièces, bords métal mat**



matt poliert, Krümel-Tablett, auf 4 Antirutschfüßchen
crumb tray, anti slip-feet
madera tratada, pies anti-deslizantes
bois traité, pieds antidérapants

| | cm | cm |
|---------|---------|----|
| 00950 9 | 48 x 32 | 2 |



in 2 Höhen erhältlich

Brötchen-Spender „INOX“
roll dispenser
dispensador de panecillos
distributeur de petits pains



hygienisch und einfach zu reinigen, mit Krümelschale
hygienic and easy to clean, with crumb tray
higiénico y fácil de limpiar, con bandeja para migas
hygiénique et facile à laver, avec plat ramasse-miettes

| | □ cm | ↑ cm | |
|---------|-------------|------|---|
| 11572 9 | 32,5 x 27,5 | 42 | für ca. 45 - 50 Brötchen for approx. 45 - 50 rolls para 45-50 panecillos pour 45-50 petits pains |
| 11573 6 | 32,5 x 27,5 | 56 | für ca. 65 - 70 Brötchen for approx. 65 - 70 rolls para 65-70 panecillos pour 65-70 petits pains |

Einzelteile / spare parts / piezas sueltas / pièces détachées

Deckel / cover / Tapa / couvercle seul

| | | | |
|---------|---------|---|--|
| 11562 0 | 32 x 27 | 1 | |
|---------|---------|---|--|



Vitrine / Thekenaufsatz
showcase
vitrina de mostrador
vitrine de comptoir



rutschfest, aus einem Teil gefertigt
antislip, monoblock produced
plástico transparente, inyectado de 1 pieza
transparente, plastique monoblock (injecté)

| | □ cm | ↑ cm | |
|---------|-----------|------|--|
| 11888 1 | 63,5 x 25 | 25 | |



Universalbox
box / sweetbox
caja dispensadora
boîte distributrice



ideal als Verkaufsbox, mit Frontdeckel
best to present sweets etc., all-purpose, with front lid
la perfecta solución para presentar golosinas. Universal, con tapa frontal
la solution idéale pour les friandises et autres. Universel, avec couvercle frontal

| | □ cm | ↑ cm | | |
|---------|-----------|------|---|--------------|
| 11884 3 | 23 x 14,5 | 15 | ○ | weiß / white |
| 11885 0 | 23 x 14,5 | 15 | ● | rot / red |

NEW



Vorratsdose mit Deckel
canister with lid
contenedor con tapa
pot en verre avec couvercle



Glaskugel mit Schraubdeckel, aromadichtem Verschluss, 1 Stck.
glass ball, aroma-tight screw cap, 1 pc.
bola de cristal, tapa de rosca aroma apretado, 1 pc.
boule de verre, bouchon à vis de l'arôme étanche, 1 pz.

| | □ cm | ↑ cm | ltr. |
|---------|-----------|------|------|
| 00637 9 | 12,5 x 19 | 18 | 1 |

Snackpresenter
snackpresenter
dispensador de bocadillos
présentoir à sandwiches



4 Mulden/Fächer
 4 slots
 para hasta 4 bocadillos
 parfait jusque 4 sandwiches

| | cm | cm |
|---------|--------|-----|
| 11969 7 | 56 x 8 | 5,5 |



Snackpresenter
snackpresenter
dispensador de bocadillos
présentoir à sandwiches



hochglanzpoliert, mit Griffmulde, für 7 Baguettes
 mirror polished finish, with recessed grip, for 7 baguettes
 inox pulido brillante, ideal para hasta 7 bocadillos
 inox poli brillant, parfait jusque maxi 7 sandwiches

| | cm | cm |
|---------|-------------|----|
| 11891 1 | 47,5 x 10,5 | 6 |

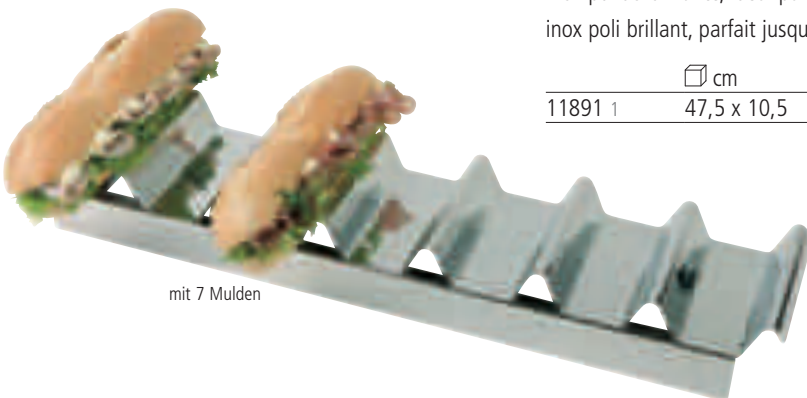

mit 7 Mulden



11887
3 Mulden

Snackpresenter
snackpresenter
dispensador de bocadillos
présentoir à sandwiches



mit Safrille und Griffmulde, passend für Vitrine 11888
 with recessed grip, suitable for showcase 11888
 asa moldeada, apto para la vitrina 11888
 anse moulée, apte pour vitrine 11888

| | cm | cm | |
|---------|---------|-----|---|
| 11887 4 | 29 x 19 | 6,5 | 3 Mulden 3 compartments 3 compartimentos 3 compartiments |
| 11889 8 | 60 x 19 | 7,5 | 6 Mulden 6 compartments 6 compartimentos 6 compartiments |



11889
6 Mulden



Ausgießer für
tropffreies Servieren

Temperaturbereich
-10°C bis +110°C

Glas-Karaffe
glass carafe
jarra
pichet verre



Deckel aus Edelstahl
stainless steel cover
tapa de acero inoxidable
couvercle inox

| | □ cm | ↑ cm | ltr. |
|---------|-------|------|------|
| 10764 9 | Ø 9,5 | 27 | 1,5 |

designed by **CULTURE FORM**



Getränke werden bis zu
4 Stunden gekühlt

1,4 ltr.

Kühlkaraffe, 3-teilig „COOL“
cooling carafe, 3 pcs. set
jarra fría, set de 3 piezas
pichet rafraîchisseur, set 3 pièces



1 Glaskaraffe mit Edelstahl-Ausgießer, öffnet und schließt selbstständig + 1 verchromter Fuß + 1 Kühlakku, Getränke werden bis zu 4 Stunden gekühlt

1 glass carafe with stainless steel pourer, open / closing autonomous + 1 chrome plated base + 1 cooling pack, up to 4 hours cooled beverages

1 botella de vidrio con vertedor inox y silicona, con autocierre + 1 base cromada + 1 placa de frío que mantiene las bebidas frescas hasta unas 4 horas

pichet en verre avec insert verseur inox et silicone, fermeture automatique + socle chromé + accumulateur de froid pour maintenir les boissons froides jusque 4 heures

| | □ cm | ↑ cm | ltr. |
|---------|------|------|------|
| 10762 5 | Ø 16 | 27 | 1,4 |

Einzelteile / spare parts / piezas sueltas / pièces détachées

Glasflasche / glass carafe / jarra de vidrio / pichet verre

| | | | |
|---------|------|----|--|
| 10761 8 | Ø 16 | 26 | |
|---------|------|----|--|

Kühlakku rund, schwarz / cooler round, black / cooler / accumulateur de froid, noir

| | | | |
|---------|--------|--|--|
| 10752 6 | Ø 10,5 | | |
|---------|--------|--|--|



Ausgießer für
tropffreies Servieren

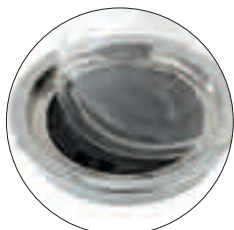

Kühlstation inkl.
Kühlakku (schwarz)
Fuß, hochglanzverchromt



1 ltr.

Glas-Karaffe
glass carafe
jarra
pichet en verre



der Deckel öffnet sich beim Ausgießen automatisch, Glas, Deckel aus Edelstahl, Silikon, hitzebeständig

cover opens automatically while pouring, stainless steel cover, glass, silicon, heat-resistant

la tapa se abre automáticamente durante el vertido, tapa de acero inoxidable, cristal, silicona, resistente al calor

le couvercle s'ouvre seul pendant le service, couvercle inox, corps en cristal, silicone, résistant à la chaleur

| | □ cm | ↑ cm | ltr. |
|---------|-------|------|------|
| 10766 3 | Ø 9,5 | 29 | 1 |

NEW



1,8 ltr.

Saftkanne
juice pitcher
jarra para zumo
pichet à jus de fruit



inklusive Stift (schwarz) zum Beschriften, Beschriftung lässt sich leicht entfernen (Kanne wird unbeschriftet geliefert)

marker (black) included, marking can be easily removed (pitcher is not marked)

rotulador incluido, fácil de borrar (se entrega sin ningún texto marcado)

marqueur inclus, facile à effacer (livraison sans texte écrit)

| | cm | cm | ltr. |
|---------|------|----|------|
| 10753 3 | Ø 12 | 24 | 1,8 |



2 ltr.

Kanne
pitcher
jarra
pichet



mit transparentem Deckel, ideal für Milch

included transparent cover, perfect for milk

perfecto para la leche

pour le lait

| | cm | cm | ltr. |
|---------|------|----|------|
| 84225 0 | Ø 14 | 21 | 2 |



2 ltr.

Kanne „ICEBLUE“
pitcher
jarra
pichet



mit transparentem Deckel

included transparent cover

tapa transparente

couvercle transparent

| | cm | cm | ltr. |
|---------|------|----|------|
| 10754 0 | Ø 12 | 26 | 2 |

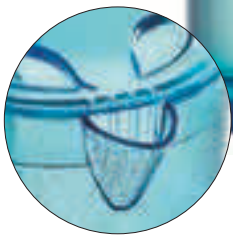

1,6 ltr.



10771

10772

10773

10774

Karaffe / Kanne
bottle
botella
bouteille



Schraubdeckel mit aromadichtem Verschluss

screwed lid, aroma-tight

tapón de rosca, impide la fuga de aromas

bouchon à visser, ne laisse pas passer les arômes

| | cm | cm | ltr. | |
|---------|------|----|------|---|
| 10771 7 | Ø 11 | 30 | 1,6 | ● |
| 10772 4 | Ø 11 | 30 | 1,6 | ● |
| 10773 1 | Ø 11 | 30 | 1,6 | ● |
| 10774 8 | Ø 11 | 30 | 1,6 | ● |



2,4 / 2,8 ltr.

Saft- / Wasserkanne
juice / water pitcher
Jarra para zumo/ agua
Pichet à eau ou jus de fruit



mit Eiswasser-Röhre, Inhalt mit Röhre 2,4 Liter
 with water ice tube, capacity with tube 2,4 liters
 Con tubo para hielo, capacidad con tubo 2,4 litros
 avec tube à glaçons plongeant pour réfrigérer, capacité 2,4 litres avec le tube

| | □ cm | ↑ cm | ltr. |
|---------|---------|------|------|
| 10769 4 | 19 x 13 | 27 | 2,8 |



3 ltr.

Saftkanne
juice pitcher
Jarra para zumo
pichet à jus de fruit



mit Eiswasser-Röhre
 with water ice tube
 Con tubo para agua
 avec tube à eau à congeler

| | □ cm | ↑ cm | ltr. |
|---------|--------|------|------|
| 10770 0 | Ø 18,0 | 29 | 3 |



2,5 ltr.

10776

2 ltr.

10775

Saftkanne
juice pitcher
Jarra para zumo
pichet à jus de fruit



| | □ cm | ↑ cm | ltr. |
|---------|------|------|------|
| 10776 2 | Ø 14 | 29 | 2,5 |
| 10775 5 | Ø 12 | 26 | 2 |



1,5 ltr.

Pitcher „CLASSIC“
pitcher
jarra
pichet



| | □ cm | ↑ cm | ltr. |
|---------|------|------|------|
| 93105 3 | Ø 13 | 21 | 1,5 |

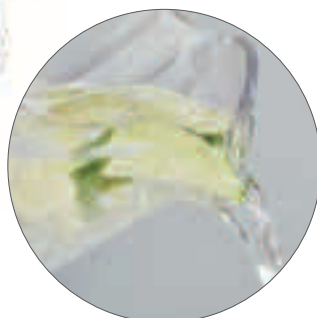



9,5 ltr.

Iso-Dispenser
insulated dispenser
dispensador isotérmico
distributeur de boisson isothermique



für heiße und kalte Getränke
 for hot and cold drinks
 para bebidas frías y calientes
 pour boissons chaudes ou froides

| | ☐ cm | ↑ cm | ltr. |
|---------|------|------|------|
| 10788 5 | Ø 24 | 42 | 9,5 |

Einzelteile / spare parts / piezas sueltas / pièces détachées

Hahn / tap / Grifo / robinet

| |
|---------|
| 10789 2 |
|---------|



Saftkanne
juice pitcher
Jarra para zumo
Pichet à jus



mit Eiswasser-Röhre und Fruchtkammer, Inhalt mit Röhre 2,2 Liter
 with water ice tube and fruit tube, capacity with tube 2,2 liters
 con tubo para agua, capacidad con tubo 2,2 litros
 avec tube à glaçons plongeant pour réfrigérer, capacité 2,2 litres avec le tube

| | ☐ cm | ↑ cm | ltr. |
|---------|---------|------|------|
| 10768 7 | 23 x 13 | 27 | 2,5 |

2,5 ltr.

Kanne /
can

Frucht-kammer /
fruit tube

Eisröhre /
ice tube



Saftdispenser Kühlung

Kühlung von „oben und unten“. Zwei Kühlakkus halten Ihre Getränke lange kühl und frisch. Der Kühlakku im Deckel (Kälte „fällt“) und der Kühlakku in der Edelstahlsäule sind einfach einzulegen. Einfach und hygienisch! Empfohlen nach HACCP! 4 Liter- oder 6 Liter-Behälter.

Juice dispenser cooling

cooling from „the top and base“. Two cooling elements keep the juice cold and fresh. The cooler in the cover and the cooler in the base/column are easy to handle. Simple handling of the exclusive nontrip tap with lever - it shuts by itself. Simple cleaning, fattening is not necessary. 4 liters or 6 liters container.

Dispensador de zumo enfriador

Enfría por abajo y por arriba. Los acumuladores de frío mantienen el zumo frío y fresco, y son fáciles, de quitar y poner, tanto el elemento, de la tapa como él de la base. Muy sencillo e higiénico. Evita tener que usar hielo. Recomendado según HACCP. Capacidad 4 o 6 litros.

Distributeur à jus de fruits réfrigéré

Double réfrigération par le haut et par le bas, grâce à 2 accumulateurs de froid faciles à changer situés pour l'un dans le couvercle (le froid „tombe“ et pour l'autre sous le récipient. Simple et parfaitement hygiénique. Permet d'éviter l'usage de glaçons. Recommandé HACCP. Capacité 4 ou 6 litres.



Saftdispenser „TOP FRESH“ juice dispenser dispensador de zumo distributeur à jus de fruit



hochglanzpoliert, Kühlung durch 2 Kühlakkus von oben und unten
mirror polished finish, cooling with 2 cooling elements from the top and base
base inox brillante, con 2 acum. de frío, 1 arriba y 1 en la base
base inox poli brillant, 2 plaques de froid (1 dans le couvercle, 1 dans le socle)

| | □ cm | ↑ cm | ltr. |
|---------|---------|------|------|
| 10800 4 | 21 x 32 | 43 | 4 |
| 10700 7 | 23 x 35 | 52 | 6 |



Saftdispenser DUO „TOP FRESH“ juice dispenser dispensador de zumo distributeur à jus de fruit



hochglanzpoliert, Kühlung durch 2 Kühlakkus von oben und unten
mirror polished finish, cooling with 2 cooling elements from the top and base
acabado pulido brillante, 2 acum. de frío (1 en la base y 1 en la tapa)
base inox poli brillant, 2 plaques de froid (1 dans le couvercle, 1 dans le socle)

| | □ cm | ↑ cm | ltr. |
|---------|---------|------|-------|
| 10720 5 | 42 x 32 | 52 | 2 x 6 |



4 ltr.
10820

6 ltr.
10730

Saftdispenser WOOD „TOP FRESH“
juice dispenser
dispensador de zumo
distributeur à jus de fruit



Buchen-Holz versiegelt, Kühlung durch 2 Kühlakkus von oben und unten
 beech wood, waterproof, cooling with 2 cooling elements from the top and base
 madera de haya con tratamiento anti humedad, de frío (1 en la base y 1 en la tapa)
 bois de hêtre traité anti-humidité, 2 plaques de froid (1 dans le couvercle, 1 dans le socle)

| | ☐ cm | ↑ cm | ltr. |
|---------|---------|------|------|
| 10820 2 | 21 x 31 | 44 | 4 |
| 10730 4 | 23 x 35 | 52 | 6 |



2 x 6 ltr.

Saftdispenser WOOD DUO „TOP FRESH“
juice dispenser
dispensador de zumo
distributeur à jus de fruit



Buchen-Holz versiegelt, Kühlung durch 2 Kühlakkus von oben und unten
 beech wood, waterproof, cooling with 2 cooling elements from the top and base
 madera de haya con tratamiento anti humedad, de frío (1 en la base y 1 en la tapa)
 bois de hêtre traité anti-humidité, 2 plaques de froid (1 dans le couvercle, 1 dans le socle)

| | ☐ cm | ↑ cm | ltr. |
|---------|---------|------|-------|
| 10740 3 | 42 x 35 | 52 | 2 x 6 |



6 + 5 ltr.

Saft- und Milchdispenser WOOD DUO „TOP FRESH“
juice and milk dispenser
dispensador de zumo
distributeur à jus de fruit



6 Liter Saftbehälter, 5 Liter Milchkanne, Kühlung durch 2 Kühlakkus von oben und unten,
 Buchen-Holz versiegelt
 6 liters juice container, 5 liters milkcan, cooling with 2 cooling elements from the top and base,
 beech wood, waterproof
 madera de haya con tratamiento anti humedad, enfriador en la base
 bois de hêtre traité anti-humidité, accum. dans le socle

| | ☐ cm | ↑ cm | ltr. |
|---------|---------|------|-------|
| 10765 6 | 42 x 35 | 52 | 6 + 5 |

designed by **KIRCHHOFF & EUWENS**



Saftdispenser „SUNDAY“
juice dispenser
dispensador de zumo
distributeur à jus de fruit

matt poliert, Kühlung durch 2 Kühlakkus von oben und unten
 satin polished finish, cooling with 2 cooling elements from the top and base
 acabado pulido brillante, 2 acum. de frío (1 en la base y 1 en la tapa)



6 ltr.

| | ☐ cm | ↑ cm | ltr. |
|---------|---------|------|------|
| 10860 8 | 21 x 35 | 48 | 6 |

Einzelteile / spare parts / piezas sueltas / pièces détachées

Saftbehälter transparent, ohne Zapfhahn / juice canister transparent, without tap
 contenedor transparente sin grifo / récipient cylindrique sans le robinet

| | | | |
|---------|------|----|---|
| 10806 6 | Ø 22 | 26 | 6 |
|---------|------|----|---|

Hahn / tap / grifo / robinet

| | | | |
|---------|--|--|--|
| 10867 7 | | | |
|---------|--|--|--|

designed by **KIRCHHOFF & EUWENS**



Dispenser „SUNDAY“
juice dispenser
dispensador de zumo o leche
distributeur à lait ou jus de fruit

matt poliert, Behälter gefrostet, Kühlung durch 2 Kühlakkus von oben und unten
 satin polished finish, canister frosted look, cooling with 2 cooling elements from the top and base

inox acabado pulido mate, 1 recipiente policarbonato aspecto glaseado, 2 enfriadores en la base y en la tapa

inox mat, récipient polycarbonate opaque, 2 accus. de froid dans le socle et dans le couvercle



6 ltr.

„gefrostet“
 ideal für Milch

| | ☐ cm | ↑ cm | ltr. |
|---------|---------|------|------|
| 10865 3 | 21 x 35 | 48 | 6 |

Einzelteile / spare parts / piezas sueltas / pièces détachées

Milchbehälter, gefrostet, ohne Zapfhahn
 milk canister, frosted look, without tap
 contenedor de leche, efecto glaseado, sin grifo
 récipient cylindrique mat (idéal pour le lait) sans le robinet

| | | | |
|---------|------|----|---|
| 10805 9 | Ø 22 | 26 | 6 |
|---------|------|----|---|

Hahn / tap / grifo / robinet

| | | | |
|---------|--|--|--|
| 10867 7 | | | |
|---------|--|--|--|

Saftdispenser DUO „SUNDAY“
juice dispenser
dispensador de zumo doble
distributeur à jus de fruit double



**2 x 6
litr.**



matt poliert, Kühlung durch 4 Kühlakkus von oben und unten
 satin polished finish, cooling with 4 cooling elements from the top and base
 inox acabado pulido mate, 4 enfriadores en la base y en la tapa
 inox mat, 4 accus. de froid (socle et couvercle)

| | ☐ cm | ↑ cm | litr. |
|---------|---------|------|-------|
| 10862 2 | 35 x 45 | 48 | 2 x 6 |

Einzelteile / spare parts / piezas sueltas / pièces détachées

Saftbehälter transparent, ohne Zapfhahn / juice canister transparent, without tap
 contenedor transparente sin grifo / récipient cylindrique sans le robinet

| | | | |
|---------|------|----|---|
| 10806 6 | Ø 22 | 26 | 6 |
|---------|------|----|---|

Hahn / tap / grifo / robinet

| | | | |
|---------|--|--|--|
| 10867 7 | | | |
|---------|--|--|--|

Saft- und Milchdispenser DUO „SUNDAY“
juice and milk dispenser
dispensador mixto zumo y leche
distributeur mixte à lait et à jus de fruit



**2 x 6
litr.**



matt poliert, 1 Behälter gefrostet, 1 Behälter transparent, Kühlung durch 4 Kühlakkus von oben und unten

satin polished finish, 1 canister frosted look, 1 canister transparent, cooling with 4 cooling elements from the top and base

inox mate, 1 recipiente opaco, 1 recipiente transparente, 4 enfriadores (base y tapa)

inox mat, 1 récipient opaque, 1 récipient transparent, 4 accus. de froid (socle et couvercle)

| | ☐ cm | ↑ cm | litr. |
|---------|---------|------|-------|
| 10864 6 | 35 x 45 | 48 | 2 x 6 |

Einzelteile / spare parts / piezas sueltas / pièces détachées

Saftbehälter transparent, ohne Zapfhahn / juice canister transparent, without tap
 contenedor transparente sin grifo / récipient cylindrique sans le robinet

| | | | |
|---------|------|----|---|
| 10806 6 | Ø 22 | 26 | 6 |
|---------|------|----|---|

Milchbehälter, gefrostet, ohne Zapfhahn

milk canister, frosted look, without tap

contenedor de leche, efecto glaseado, sin grifo

récipient cylindrique mat (idéal pour le lait) sans le robinet

| | | | |
|---------|------|----|---|
| 10805 9 | Ø 22 | 26 | 6 |
|---------|------|----|---|

Hahn / tap / grifo / robinet

| | | | |
|---------|--|--|--|
| 10867 7 | | | |
|---------|--|--|--|

**HOT
PRICE**

8 ltr.



Saftdispenser „INOX STAR“
juice dispenser
dispensador de zumo
distributeur à jus de fruit



Edelstahl-Crasheisröhre herausnehmbar
stainless steel crash ice tube
con tubo inox refrigerante extraíble para hielo picado
avec tube inox réfrigérant amovible pour glace pilée

| | □ cm | ↑ cm | ltr. |
|---------|---------|------|------|
| 10795 3 | 36 x 26 | 55 | 8 |

Kühlung durch
Crasheisröhre.
Einfach mit
Crasheis füllen!

Buffet. Banquet
buffet. banquet

**HOT
PRICE**

2 x 8
ltr.



Kühlung durch
Crasheisröhre.
Einfach mit
Crasheis füllen!

Saftdispenser DUO „INOX STAR“
juice dispenser
dispensador de zumo
distributeur à jus de fruit



Edelstahl-Crasheisröhre herausnehmbar
stainless steel crash ice tube
con tubo inox refrigerante extraíble para hielo picado
avec tubes inox réfrigérants amovibles pour glace pilée

| | □ cm | ↑ cm | ltr. |
|---------|---------|------|-------|
| 10810 3 | 36 x 52 | 55 | 2 x 8 |

Einzelteile / spare parts / piezas sueltas / pièces détachées

Behälter / container / recipiente / récipient

| | |
|---------|---|
| 10796 0 | 8 |
|---------|---|

Deckel 18/10 Edelstahl hochglanzpoliert / cover 18/10 stainless steel mirror polished finish
tapa 18/10 inox pulido brillante / couvercle inox 18/10 poli brillant

| |
|---------|
| 10797 7 |
|---------|

Crasheisröhre / crash ice tube / tubo para hielo picado / tube pour glace pilée

| |
|---------|
| 10798 4 |
|---------|

Non-Drip Hahn / non-drip-tap / grifo anti-goteo / robinet anti-goutte

| |
|---------|
| 10799 1 |
|---------|

Dichtungsring / sealing ring / arandela / rondelle

| |
|---------|
| 10793 9 |
|---------|

Silikonichtung / sealing / junta / joint

| |
|---------|
| 10794 6 |
|---------|



4 ltr.

Der Kühlakku leitet die Kälte direkt in die Porzellan-Milchkanne.

Milchkanne „TOP FRESH“
milk dispenser
dispensador de leche
distributeur à lait



Kunststoff gefrostet, inkl. Porzellanschild zum Beschriften, 1 Kühlakku im Fuß
acrylic frosted, incl. porcelain sign, 1 cooler in base
acrílico glaseado, incluye cartelito en porcelana, 1 enfriador en la base
socle acrylique, indicateur en porcelaine inclus, plaque de froid dans le socle

| | ☐ cm | ↑ cm | ltr. |
|---------|---------|------|------|
| 10850 9 | 31 x 21 | 42 | 4 |

Einzelteile / spare parts / piezas sueltas / pièces détachées

Milchkanne Porzellan, ohne Zapfhahn / milkcan porcelain, without tap
Jarra de leche sin grifo / récipient en porcelaine sans robinet

| | | | |
|---------|------|----|---|
| 10825 7 | Ø 18 | 25 | 4 |
|---------|------|----|---|



2 Größen
4 + 10
ltr.

Der Kühlakku leitet die Kälte direkt in die Porzellan-Milchkanne.

Milchkanne „TOP FRESH“
milk dispenser
dispensador de leche
distributeur à lait



Buchen-Holz versiegelt, inkl. Porzellanschild zum Beschriften, 1 Kühlakku im Fuß
beech wood, waterproof, incl. porcelain sign, 1 cooler in base
madera de haya, resistente al agua, incluye placa de porcelana, 1 enfriador en la base.
socle bois hêtre traité, indicateur en porcelaine inclus, plaque de froid dans le socle

| | ☐ cm | ↑ cm | ltr. |
|---------|-----------|------|------|
| 10840 0 | 23 x 32 | 42 | 4 |
| 10757 1 | 27 x 38,5 | 45 | 10 |

Einzelteile / spare parts / piezas sueltas / pièces détachées

Milchkanne Porzellan, ohne Zapfhahn / milkcan porcelain, without tap
Jarra de leche sin grifo / récipient en porcelaine sans robinet

| | | | |
|---------|------|----|----|
| 10825 7 | Ø 18 | 25 | 4 |
| 10758 8 | Ø 22 | 26 | 10 |

Deckel für 10840 / cover for 10840 / para tapa 10840 / pour couvercle 10840

| | | | |
|---------|--|--|--|
| 10859 2 | | | |
|---------|--|--|--|

Deckel für 10757 / cover for 10757 / para tapa 10757 / pour couvercle 10757

| | | | |
|---------|--|--|--|
| 10759 5 | | | |
|---------|--|--|--|

Schild und Kette / shield and chain / placa y cadena / indicateur porcelaine avec chaînette

| | | | |
|---------|--|--|--|
| 10756 4 | | | |
|---------|--|--|--|

Zapfhahn / tap / grifo / robinet

| | | | |
|---------|--|--|--|
| 10907 0 | | | |
|---------|--|--|--|



3 ltr.
10835

5 ltr.
10755

Milchkanne WOOD „TOP FRESH“
milk dispenser
dispensador de leche
distributeur à lait



Buchen-Holz versiegelt, 1 Kühlakku im Standfuß, „original Milchkanne mit Henkel“
beech wood, 1 cooler in base, original milkcan
madera de haya, 1 acumulador de frio en base
bois de hêtre, 1 plaque de froid dans le socle

| | □ cm | ↑ cm | ltr. |
|---------|---------|------|------|
| 10835 6 | 21 x 32 | 39 | 3 |
| 10755 7 | 23 x 35 | 47 | 5 |



6 + 5
ltr.

Saft- und Milchdispenser MIX „TOP FRESH“
juice and milk dispenser
dispensador mixto zumo y leche
distributeur mixte à lait et à jus de fruit



6 Liter Saftbehälter, 5 Liter Milchkanne, Kühlung durch 2 Kühlakkus von oben und unten
6 liters juice container, 5 liters milkcan, cooling with 2 cooling elements from the top and base
recipiente de zumo 6 litros, recipiente de leche 5 litros, 2 enfriadores
récipient à jus 6 L, récipient à lait 5 L, 2 accus. de froid

| | □ cm | ↑ cm | ltr. |
|---------|---------|------|-------|
| 10760 1 | 42 x 35 | 52 | 6 + 5 |



3 ltr.
10830

5 ltr.
10750

Milchkanne „TOP FRESH“
milk dispenser
dispensador de leche
distributeur à lait



hochglanzpoliert, 1 Kühlakku im Standfuß, „original Milchkanne mit Henkel“
mirror polished finish, 1 cooler in base, original milkcan
inox brillante, 1 acumulador de frio en la base, recipiente „lechera“
inox poli brillant, 1 accum. de froid dans le socle, design „pot à lait“

| | □ cm | ↑ cm | ltr. |
|---------|---------|------|------|
| 10830 1 | 21 x 32 | 39 | 3 |
| 10750 2 | 23 x 35 | 45 | 5 |

Einzelteile / spare parts / piezas sueltas / pièces détachées

Milchkanne ohne Zapfhahn / milkcan without tap
jarra de leche sin grifo / récipient à lait sans robinet

| | | | |
|---------|------|----|---|
| 10833 2 | Ø 16 | 22 | 3 |
| 10663 5 | Ø 22 | 26 | 5 |

BRIDGE designed by CULTURE FORM



siehe auch Seite 166 / page 166



inklusive 3 Magnetschilder:
 „ORANGE“
 „APPLE“
 „GRAPEFRUIT“

Saftdispenser „BRIDGE“
 juice dispenser
 dispensador de zumo
 distributeur à jus de fruit



Kühlung durch 2 Kühlakkus von oben und unten
 cooling with 2 cooling elements from the top and base
 2 acum. de frío (1 en la base y 1 en la tapa)
 2 plaques de froid (1 dans le couvercle, 1 dans le socle)

| | □ cm | ↑ cm | ltr. | | |
|---------|-------------|------|------|-------|---|
| 10870 7 | 31,0 x 20,0 | 42 | 4 | Ahorn | ● |
| 10871 4 | 35,5 x 22,0 | 50 | 6 | Ahorn | ● |
| 10872 1 | 31,0 x 20,0 | 42 | 4 | Wenge | ● |
| 10873 8 | 35,5 x 22,0 | 50 | 6 | Wenge | ● |



Einzelteile / spare parts / piezas sueltas / pièces détachées

Deckel / cover / tapa / couvercle
für ltr. / for ltr. / para ltr.

| | | |
|----------|---|---|
| 1) 10701 | 4 | 6 |
| 1) 10801 | 1 | 4 |

Kühlakku / cooler / acumulador de frío / accumulateur de froid

| | | |
|----------|---|-------|
| 2) 10777 | 9 | 4 / 6 |
|----------|---|-------|

Behälter inkl. Zapfhahn / container inc. tap / Recipiente con grifo / récipient sans robinet

| | | |
|----------|---|---|
| 3) 10703 | 8 | 6 |
| 3) 10803 | 5 | 4 |

Softbehälter transparent, ohne Zapfhahn / juice canister transparent, without tap
contenedor transparente sin grifo / récipient cylindrique sans le robinet

| | | |
|----------|---|---|
| 3) 10704 | 5 | 6 |
| 3) 10804 | 2 | 4 |

Non-Drip Hahn / non-drip tap / Grifo anti-goteo / robinet anti-goutte

| | | |
|----------|---|---|
| 4) 10707 | 6 | 6 |
| 4) 10807 | 3 | 4 |

Dichtungsring / sealing ring / Arandela / rondelle

| | | |
|----------|---|-------|
| 5) 10608 | 8 | 4 / 6 |
|----------|---|-------|

Einsatz / insert / aro inox / cercle inox

| | | |
|----------|---|---|
| 6) 10708 | 3 | 6 |
| 6) 10808 | 0 | 4 |

Standfuß 18/10 Edelstahl / column 18/10 stainless steel
base inox 18/10 socle inox 18/10

| | | |
|----------|---|---|
| 7) 10709 | 0 | 6 |
| 7) 10809 | 7 | 4 |

Tropfgitter 18/10 Edelstahl / drip lattice 18/10 stainless steel
Rejilla recoge gotas 18/10 / grille ramasse-gouttes

| | | |
|----------|---|-----|
| 8) 10712 | 0 | 6 |
| 8) 10713 | 7 | DUO |
| 8) 10812 | 7 | 4 |

Bodenplatte 18/10 Edelstahl / footing 18/10 stainless steel
base de 18/10 acero / socle inox 18/10

| | | |
|----------|---|-------------|
| 9) 10710 | 6 | 6 |
| 9) 10711 | 3 | DUO / 6 + 6 |
| 9) 10814 | 1 | 4 |

Zubehör / Reinigungsset - für die regelmäßige Reinigung

1x Dichtung, 2x Dichtungsring (transparent), 1x Dichtungsring (schwarz / weiß)
1x seal, 2x sealing ring (transparent), 1x sealing ring (black / white)

| | | |
|-------|---|--------------------------|
| 10714 | 4 | für Zapfhahn 10707/10786 |
| 10715 | 1 | für Zapfhahn 10807 |
| 10716 | 8 | für Zapfhahn 10907 |
| 10717 | 5 | für Zapfhahn 10867 |

BUFFET-PYRAMIDEN

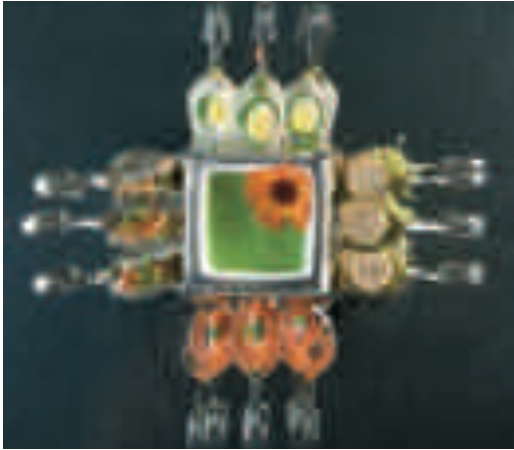



Buffet-Pyramide Set „LARGE“

108 Schlitz für Löffel und 168 Löcher für Spieße
108 slots for spoons and 168 holes for spits
108 ranuras para cucharas y 168 agujeros para pinchos
108 emplacements pour cuillères et 168 trous pour les piques

Set bestehend aus: 1 Buffet-Pyramide, Edelstahl, 30 x 30 cm, H 53 cm + 1 Drehplatte (kugelgelagert) + 1 Tablett, Melamin weiß, 51 x 51 cm, H 3 cm + 1 Schale, Edelstahl, 11 x 11 cm, H 1 cm + 108 Gourmet-Löffel + 500 Spieße aus Holz

set: 1 buffet pyramid, stainless steel, 30 x 30 cm, h 53 cm + 1 plate, rotating (with ball bearing) + 1 tray, melamine white, 51 x 51 cm, h 3 cm + 1 bowl, stainless steel, 11 x 11 cm, h 1 cm + 108 party spoons + 500 spits, wood

1 conjunto pirámide buffet, acero inoxidable 30 x 30 altura 53 cm, 1 base giratoria con rodamientos, 1 bandeja melamina blanca, 51 x 51 altura de 3 cm, 1 bol, acero inoxidable 11 x 11 cm, altura 1 cm, 108 cucharas y 500 pinchos de madera

ensemble pyramide de buffet inox, 30x30 cm x H. 53 + support tournant sur roulements + plateau mélamine blanc 51x51xH. 3 cm + coupelle 11x11x1 cm + 108 cuillères Gourmet + 500 pics en bois

| | □ cm | ↑ cm |
|---------|---------|------|
| 12442 4 | 30 x 30 | 53 |



Buffet-Pyramide Set „MEDIUM“

48 Schlitz für Löffel und 64 Löcher für Spieße
48 slots for spoons and 64 holes for spits
48 ranuras para cucharas y 64 agujeros para pinchos
48 emplacements pour cuillères et 64 trous pour les piques

Set bestehend aus: 1 Buffet-Pyramide, Edelstahl + 1 Drehplatte (kugelgelagert) + 1 Tablett, Melamin weiß, 37 x 37 cm, H 3 cm + 1 Schale, Edelstahl 11 x 11 cm, H 1 cm + 48 Gourmet-Löffel + 70 Spieße aus Holz

set: 1 buffet pyramid, stainless steel + 1 plate, rotating (with ball bearing) + 1 tray, melamine white, 37 x 37 cm, h 3 cm + 1 bowl, stainless steel, 11 x 11 cm, h 1 cm + 48 party spoons + 70 spits, wood

1 conjunto pirámide buffet, acero inoxidable, 1 base giratoria con rodamientos, 1 bandeja melamina blanca, 37 x 37 altura 3 cm, 1 bol acero inoxidable 11 x 11 cm, altura 1 cm, 48 cucharas, 70 pinchos de madera

ensemble pyramide de buffet inox + support tournant sur roulements + plateau mélamine blanc 37x37xH. 3 cm + coupelle 11x11x1 cm + 48 cuillères Gourmet + 70 pics en bois

| | □ cm | ↑ cm |
|---------|---------|------|
| 12441 7 | 37 x 37 | 33 |



Buffet-Pyramide Set „SMALL“

24 Schlitz für Löffel und 18 Löcher für Spieße
24 slots for spoons and 18 holes for spits
24 ranuras para cucharas y 18 agujeros para pinchos
24 emplacements pour cuillères et 18 trous pour les piques

Set bestehend aus: 1 Buffet-Pyramide, Edelstahl, 17 x 17 cm, H 17 cm + 1 Schale, Edelstahl, 11 x 11 cm, H 1 cm + 24 Gourmet-Löffel + 20 Spieße aus Holz

set: 1 buffet pyramid, stainless steel, 17 x 17 cm, h 17 cm + 1 bowl, stainless steel, 11 x 11 cm, h 1 cm + 24 party spoons + 20 spits, wood

set: 1 conjunto de pirámide acero inoxidable, 17 x 17, altura de 17 cm, 1 bol de acero inoxidable 11 x 11 cm. Altura, 1 cm, 24 cucharas y 20 pinchos de madera

ensemble pyramide de buffet inox 17x17xH. 3 cm + coupelle 11x11x1 cm + 24 cuillères Gourmet + 20 pics en bois

| | □ cm | ↑ cm |
|---------|---------|------|
| 12440 0 | 17 x 17 | 17 |

GOURMET-DISPLAYS

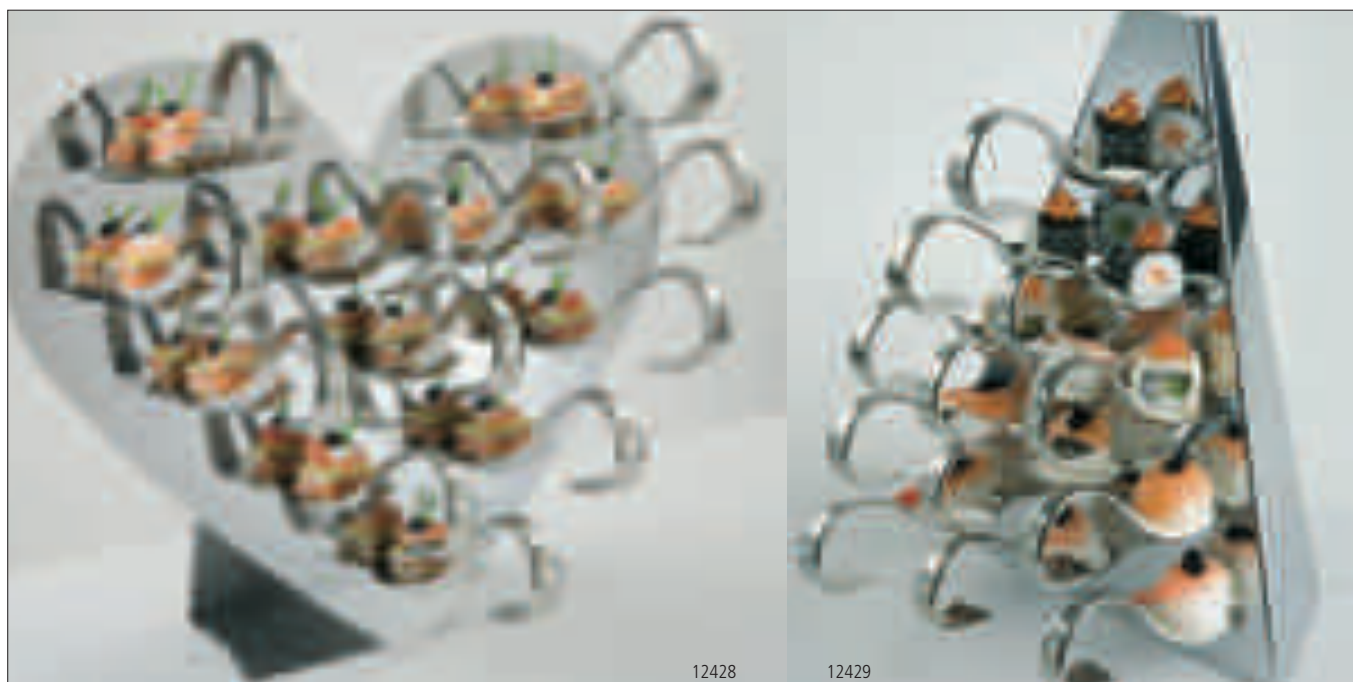

Gourmet-Display „FLIRT“

12 Schlitz für Löffel und 12 Löcher für Spieße
12 slots for spoons and 12 holes for spits
12 ranuras para cucharas y 12 agujeros para pinchos
12 emplacements pour cuillères et 12 trous pour les piques



Set bestehend aus: 1 Display, Edelstahl + 12 Gourmet-Löffel + 20 Spieße aus Holz
 set: 1 display, stainless steel + 12 party spoons + 20 spits, wood
 1 conjunto de presentación inox con 12 cucharas y 20 pinchos de madera
 set présentoir inox avec 12 cuillères et 20 pics en bois

| | ☐ cm | ↑ cm |
|---------|---------|------|
| 12428 8 | 30 x 14 | 32 |



Gourmet-Display „TRIANGOLO“

12 Schlitz für Löffel und 13 Löcher für Spieße
12 slots for spoons and 13 holes for spits
12 ranuras para cucharas y 13 agujeros para pinchos
12 emplacements pour cuillères et 13 trous pour les piques



Set bestehend aus: 1 Display, Edelstahl + 12 Gourmet-Löffel + 20 Spieße aus Holz
 set: 1 display, stainless steel + 12 party spoons + 20 spits, wood
 set: 1 conjunto acero inoxidable, 12 cucharas y 20 pinchos de madera
 set présentoir inox avec 12 cuillères et 20 pics en bois

| | ☐ cm | ↑ cm |
|---------|-----------|------|
| 12429 5 | 21,5 x 14 | 27 |



Buffet-Pyramide
buffet pyramid
pirámide buffet
pyramide de buffet



| | ☐ cm | ↑ cm | |
|---------|---------|------|---|
| 12432 5 | 30 x 30 | 53 | 108 Schlitz für Löffel und 168 Löcher für Spieße 108 slots for spoons and 168 holes for spits 108 ranuras para cucharas y 168 agujeros para pinchos 108 emplacements pour cuillères et 168 trous pour les piques |
| 12431 8 | 22 x 22 | 31 | 48 Schlitz für Löffel und 64 Löcher für Spieße 48 slots for spoons and 64 holes for spits 48 ranuras para cucharas y 64 agujeros para pinchos 48 emplacements pour cuillères et 64 trous pour les piques |
| 12430 1 | 17 x 17 | 17 | 24 Schlitz für Löffel und 18 Löcher für Spieße 24 slots for spoons and 18 holes for spits 24 ranuras para cucharas y 18 agujeros para pinchos 24 emplacements pour cuillères et 18 trous pour les piques |

Spieße / spits / pinchos / pic

| | → cm | pcs. |
|---------|------|------|
| 00679 9 | 15 | 500 |

Buffet . Banquet
 buffet . banquet



Melamin Servierartikel
melamine serving items
melamina para servir
mélamine de service



schneeweiße und glänzende Oberfläche, „sieht aus wie Porzellan“, hygienisch, sehr harte Oberfläche, weiß

non-odiferous, tasteless, hygienic, white

no guarda olores, sin sabor, higiénica, blanco

neutres aux odeurs et saveurs, hygiénique, blanche

| | ☐ cm | ↑ cm | |
|---------|-------------|------|--|
| 83404 0 | 51,0 x 51,0 | 3 | Melamintablett / tray melamine bandeja de melamina / plateau mélamine |
| 83405 7 | 37,0 x 37,0 | 3 | Melamintablett / tray melamine bandeja de melamina / plateau mélamine |
| 83410 1 | 12,5 x 12,5 | 6,5 | Schale / bowl bol / coupelle |

vielseitig einsetzbar bei Buffet-Platten,
 rutschsicher und
 kugelgelagert



drehbar
 rotating

Drehplatte
plate, rotating
base giratoria
base tournante



matt poliert, kugelgelagert

satín polished finish, with ball bearing

acero inoxidable mate, giratoria con rodamientos

inox mat, monté sur roulements

| | ☐ cm | ↑ cm |
|---------|------|------|
| 12435 6 | Ø 23 | 1,5 |
| 12436 3 | Ø 33 | 1,5 |

GOURMET LÖFFEL



00691 Edelstahl-Gold-Look



00677 Edelstahl poliert



00692 Edelstahl-Kupfer-Look



Gourmet-Löffel „CLASSIC“

party spoon
cuchara
cuillère



→ cm

| | | |
|---------|------|---------------------------------------|
| 00677 5 | 13,5 | Edelstahl-Look / stainless steel look |
| 00691 1 | 12 | Gold-Look / gold look |
| 00692 8 | 12 | Kupfer-Look / copper look |

Chafing Dish . Chafing Dish Zubehör
chafing dish . chafing dish extras
chafing dish y accesorios
chafing-dish et accessoires

PREMIUM



Chafing Dish GN1/1 „PREMIUM“



1 Gestell + 1 Wasserbecken mit Sandwichboden + 1 Wasserbeckenrahmen + 1 Deckel mit hydraulischem Gelenk + 1 GN1/1 Behälter 65 mm tief, hitzebeständige Griffe, hochwertige Verarbeitung, ausschließlich für Induktionskochfelder

1 frame + 1 waterpan with sandwich base + 1 frame for waterpan + 1 hydraulic cover + 1 GN 1/1 container 65 mm, heat-resistant handles, high quality, only for induction plates

1 marco, baño maría con base sandwich, 1 marco con tapa hidráulica, cubeta GN 1/1 pan 65 mm profundo, buenos acabados, solamente para inducción

1 pied support, 1 bac bain-marie avec fond sandwich, 1 cadre avec couvercle hydraulique, 1 bac GN 1/1 - 65mm, belle qualité, uniquement pour induction



9 ltr.

Patent
„Geschmacksmuster geschützt“

| | □ cm | ↑ cm | ltr. |
|---------|------------------------------|------|------|
| 12370 0 | 66 x 48 | 33 | 9 |
| 12373 1 | ohne Gestell / without frame | | 9 |

Einzelteile / spare parts / piezas sueltas / pièces détachées

Induktionskochplatte für Chafing Dish / induction plate for chafing dish
placa de inducción para chafing dish / plaque à induction pour chafing dish

| | |
|---------|-------|
| 12295 6 | 900 W |
|---------|-------|



Langlebige Deckelbremse

Abnehmbarer Deckel, dieser lässt sich spielend leicht öffnen und schliessen, der Lauf des Deckels wird professionell gedämpft.



Kondenswasser - Rücklaufsystem

Kondenswasser wird in das Wasserbecken zurückgeführt.



Sandwichboden / Kapselboden

Induktionsfähiger Boden, direkt auf dem Induktionskochfeld einsetzbar. Perfekte Wärmeverteilung und Steuerung.



Chafing Dish rund „PREMIUM“



6 ltr.

1 Gestell + 1 Wasserbecken mit Sandwichboden + 1 Wasserbeckenrahmen + 1 Deckel mit hydraulischem Gelenk + 1 runder Speisenbehälter, hitzebeständiger Griff, hochwertige Verarbeitung, für Induktionskochfelder geeignet

1 frame + 1 waterpan with sandwich base + 1 frame for waterpan + 1 hydraulic cover + 1 round foodpan, heat-resistant handles, high quality, good for induction plates

1 soporte, 1 baño maría con base sandwich, 1 marco con baño maría, 1 tapa hidráulica, 1 cubeta

piéd support, bac bain-marie avec fond sandwich, cadre avec couvercle hydraulique, belle qualité, uniquement pour induction

| | □ cm | ↑ cm | ltr. |
|---------|------------------------------|------|------|
| 12371 7 | 44 x 54 | 33 | 6 |
| 12374 8 | ohne Gestell / without frame | | 6 |

Einzelteile / spare parts / piezas sueltas / pièces détachées

Induktionskochplatte für Chafing Dish / induction plate for chafing dish
placa de inducción para chafing dish / plaque à induction pour chafing dish

| | |
|---------|-------|
| 12295 6 | 900 W |
|---------|-------|

Speiseneinsatz / foodpan / cubeta / bac supérieur

| | |
|---------|--------|
| 12366 3 | 6 ltr. |
|---------|--------|



Chafing Dish rund „PREMIUM“



10 ltr.

1 Gestell + 1 Wasserbecken mit Sandwichboden + 1 Wasserbeckenrahmen + 1 Deckel mit hydraulischem Gelenk + 1 runder Speisenbehälter, hitzebeständige Griffe, hochwertige Verarbeitung, für Induktionskochfelder geeignet

1 frame + 1 waterpan with sandwich base + 1 frame for waterpan + 1 hydraulic cover + 1 round foodpan, heat-resistant handles, high quality, good for induction plates

1 soporte, 1 baño maría con base sandwich, 1 marco con baño maría, 1 tapa hidráulica, 1 cubeta

piéd support, bain-marie avec base sandwich, cadre avec bac bain-marie, couvercle hydraulique, bac

| | □ cm | ↑ cm | ltr. |
|---------|------------------------------|------|------|
| 12372 4 | 44 x 48 | 39 | 10 |
| 12375 5 | ohne Gestell / without frame | | 10 |

Einzelteile / spare parts / piezas sueltas / pièces détachées

Induktionskochplatte für Chafing Dish / induction plate for chafing dish
placa de inducción para chafing dish / plaque à induction pour chafing dish

| | |
|---------|-------|
| 12295 6 | 900 W |
|---------|-------|

Speiseneinsatz / foodpan / cubeta / bac supérieur

| | |
|---------|---------|
| 12397 7 | 10 ltr. |
|---------|---------|



Fixierschraube / Rutsicherung
Höhenverstellbares Gelenk, fixiert das Gerät in dem Gestell und auf dem Tisch.



Induktionskochplatte Nr.12295
Induktionskochplatte wird einfach in das Gestell gelegt.



Stapelbar
Chafing Dish Rahmen sind übereinander stapelbar. Platzsparend und rutschfest stapeln und transportieren.

GLOBE



die Deckelbremse sorgt für langsames Schließen

the revolving cover closes gently, thanks to a special built-in axle resistance

los frenos del sistema garantizan un cierre suave de la tapa

Système avec frein pour une fermeture en douceur du couvercle



abnehmbarer Deckel mit Wasserrücklaufsystem

lid can be taken off, with water runback system

tapa fácil de desmontar, y canal incorporado para recuperar el agua condensada

couvercle facile à démonter, rainure pour récupérer les gouttes de condensation



Kondenswasser wird in das Wasserbecken zurückgeführt

condensed water is led back into the waterpan

el agua de condensación vuelve a la cubeta de agua

l'eau de condensation retourne dans le bac d'eau



für alle Herdarten geeignet, auch für Induktionskochplatten

suitable for all kinds of ovens, even induction cookers

apto para todas las fuentes de calor, incluso inducción

apte pour toutes les sources de chaleur, y compris induction



Chafing Dish „GLOBE“



12394



12404

GN1/1
9 ltr.

hochglanzpoliert, mit abnehmbarem hydraulischen Edelstahl-Deckel, Sandwichboden sorgt für optimale Wärmeleitung, für Induktionsplatten geeignet

Set: Gestell + Wasserbecken + Speisenbehälter GN1/1 65 mm tief + Löffelablage + 2 Brennpastenbehälter + Metallrahmen für Induktionskochplatte

mirror polished finish, removable hydraulic cover, sandwich base, optimum heat distribution set: frame + waterpan + foodpan GN1/1, 65 mm, 9 l + cutlery compartment ladles + 2 burner holder + frame for induction plate

pulido brillante, con tapa hidráulica extraíble, fondo difusor sandwich apto para inducción. Incluye: 1 pie, 1 cubeta baño maría, 1 cubeta GN 1/1 65 mm - 5,5 l, 1 soporte para cuchara (sin cuchara), 2 quemadores, marco inox para la placa de inducción

poli brillant, couvercle hydraulique amovible, fond diffuseur sandwich apte pour induction. Comprend: pied, cuve bain-marie, bac inox GN 1/1-65 mm - 5,5 L, porte-louche (louche non incluse), 2 brûleurs, cadre inox pour la plaque à induction

| | cm | cm | GN | ltr. |
|---------|-------------|----|--|------|
| 12394 6 | 66,5 x 44,0 | 34 | 1/1 | 9 |
| 12404 2 | 66,5 x 44,0 | 34 | Set mit Edelstahl- / Glasdeckel set with cover stainless steel / glass con tapa inox con ventana avec couvercle inox et fenêtre verre | |

Einzelteile / spare parts / piezas sueltas / pièces détachées

Deckel mit Glasfenster / cover with glass insert / tapa con cristal / couvercle inox et verre

12391 5

Deckel Edelstahl / cover stainless steel / tapa de acero inoxidable / couvercle tout inox

12386 1

Metallrahmen für Induktionskochplatte / frame for induction plate
estructura o marco para placa de inducción / cadre support inox pour plaque induction

12296 3

Induktionskochplatte für Chafing Dish / induction plate for chafing dish
placa de inducción para chafing dish / plaque à induction pour chafing dish

12295 6 900 W



12295

Induktionsplatte kann nur in Verbindung mit dem entsprechenden Rahmen genutzt werden



12296



10 ltr.

Suppen-Kugel „GLOBE“ soup bowl



hochglanzpoliert, inkl. Speisenbehälter, mit einhängbarer Löffelablage, Sandwichboden sorgt für optimale Wärmeverteilung, für Induktionsplatten geeignet, einfaches Anbringen und Entfernen des Deckels, hitzeisolierende Griffe (Lieferung ohne Löffel)

mirror polished finish, incl. foodpan, with fitting compartment for ladles, sandwich bottom for optimum heat distribution, gentle opening of the lid, heat-resistant handles (delivery without ladle)

acabado pulido brillante, cubeta sopa inox, platillo a colgar para el cucharón, fondo difusor sandwich, apto para inducción, tapa con apertura controlada, asas frías (cucharón no incluido)

poli brillant, récipient à soupe inox, repose-couvert à accrocher, fond diffuseur sandwich, apte pour induction, couvercle à ouverture contrôlée, anses froides (louche non incluse)

| | □ cm | ↑ cm | ltr. |
|---------|------|------|------|
| 12399 1 | Ø 48 | 32 | 10 |

Einzelteile / spare parts / piezas sueltas / pièces détachées

Gestell inkl. Brenner / frame incl. burner / soporte incluyendo quemador / support, brûleur inclus

12396 0

Speisenbehälter / foodpan / Cubeta superior / bac supérieur

12397 7 10 ltr.



10 ltr.

Suppen-Kugel inkl. Gestell „GLOBE“ soup bowl with stand



hochglanzpoliert, inkl. Speisenbehälter, 1 Brennpastenbehälter, mit einhängbarer Löffelablage, Sandwichboden sorgt für optimale Wärmeverteilung, für Induktionsplatten geeignet, einfaches Anbringen und Entfernen des Deckels, hitzeisolierende Griffe, 1 Metallrahmen für Induktionskochplatten

mirror polished finish, incl. foodpan and 1 burner holder, with fitting compartment for ladles, sandwich bottom for optimum heat distribution, gentle opening of the lid, heat-resistant handles, frame for induction plate

acabado pulido brillante, cubeta sopa inox, 1 quemador, platillo a colgar para el cucharón, fondo difusor sandwich, apto para inducción, tapa con apertura controlada, asas frías, marco para placa de inducción

poli brillant, récipient à soupe inox, 1 brûleur, repose-couvert à accrocher, fond diffuseur sandwich, apte pour induction, couvercle à ouverture contrôlée, anses froides, cadre support inox pour plaque à induction

| | □ cm | ↑ cm | ltr. |
|---------|------|------|------|
| 12398 4 | Ø 48 | 45 | 10 |

Einzelteile / spare parts / piezas sueltas / pièces détachées

Metallrahmen für Induktionskochplatten / frame for induction plate
Marco para placa de inducción / cadre support inox pour plaque induction

12291 8

Induktionskochplatte für Chafing Dish / induction plate for chafing dish
placa de inducción para chafing dish / plaque à induction pour chafing dish

12295 6 900 W



6 ltr.

12390

Induktionsplatte kann nur in Verbindung mit dem entsprechenden Rahmen genutzt werden

12291

12295

Chafing Dish „GLOBE“



hochglanzpoliert, mit abnehmbarem hydraulischen Edelstahl-Deckel, Sandwichboden sorgt für optimale Wärmeleitung, für Induktionsplatten geeignet
Set: Gestell + Wasserbecken + Speisenbehälter rund + Löffelablage + Brennpastenbehälter + Metallrahmen für Induktionskochplatte

mirror polished finish, removable hydraulic cover, sandwich base, optimum heat distribution set: frame + waterpan + foodpan round + cuttlery compartment ladles + burner holder + frame for induction plate

pulido brillante, con tapa hidráulica extraíble, fondo difusor sandwich apto para inducción.
Incluye: 1 pie, 1 cubeta baño maria, 1 cubeta redonda, 1 soporte para cuchara (sin cuchara), 1 quemador, marco inox para la placa de inducción

brillant, couvercle hydraulique amovible, fond diffuseur sandwich apte pour induction.
Comprend: pied, cuve bain-marie, bac inox rond, porte-louche (louche non incluse), 1 brûleur, cadre inox pour la plaque à induction

| | ▣ cm | ↑ cm | ltr. |
|---------|---------------|------|---|
| 12393 9 | Ø 35, 50 x 45 | 34 | 6 |
| 12403 5 | Ø 35, 50 x 45 | 34 | mit Edelstahl- / Glasdeckel with cover stainless steel / glass con tapa de acero inoxidable y cristal avec couvercle inox et fenêtre verre |

Einzelteile / spare parts / piezas sueltas / pièces détachées

Deckel mit Glasfenster / cover with glass insert / tapa con cristal / couvercle inox et verre

12390 8

Deckel Edelstahl / cover stainless steel / tapa de acero inoxidable / couvercle tout inox

12385 4

Metallrahmen für Induktionskochplatten / frame for induction plate
Marco para placa de inducción / cadre support inox pour plaque induction

12291 8

Induktionskochplatte für Chafing Dish / induction plate for chafing dish
placa de inducción para chafing dish / plaque à induction pour chafing dish

12295 6 900 W

Speiseneinsatz / foodpan / cubeta / bac supérieur

12366 3 6 ltr.



82210

82215

Porzellan-Einsatz porcelain insert bandeja de porcelana bac supérieur en porcelaine



| | ▣ cm | ↑ cm | ltr. |
|---------|-----------|------|------|
| 82210 8 | Ø 39 | 6,5 | 4,3 |
| 82215 3 | 39 x 19,5 | 6,5 | 4,0 |

rund / round / redondo / rond
unterteilt / subdivided
2 compartimentos / 2 compartiments

ROYAL

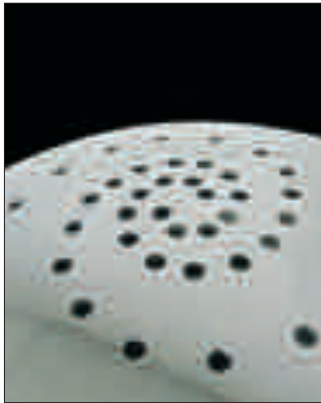

Die Löcher im Deckel dienen der Dampfentweichung.

steam release holes on cover

evacuación del vapor a través de los agujeros de la tapa

furos na tampa para libertação do vapor

Eine spezielle Rinne führt das Kondenswasser vom Deckel in das Wasserbecken zurück!

A special channel leads condensed water from the lid back into the waterpan

Una ranura devuelve el agua de condensación de la tapa a la cubeta de agua

Une rainure renvoie l'eau de condensation du couvercle au bac d'eau

Abnehmbare Brennerplatten: Chafer kann mit Brenner oder Heizplatte benutzt werden.

The plate for the fuel holders can be taken off, the chafer can be used either with fuel or with electric heating plates

La placa que soporta los quemadores se puede quitar y el bañomaría se puede usar con pasta o con resistencia eléctrica

La plaque-support pour les brûleurs se démonte pour permettre l'usage soit avec brûleurs, soit avec résistance électrique



Deckelbremse:
sanftes Öffnen des
Rolltop-Deckels durch
eingebaute
Deckelbremse



12289

Rolltop-Chafing Dish „ROYAL“



Speisenbehälter + Rolltop-Deckel hochglanzpoliert + Brennpastenbehälter, sanftes Öffnen des Deckels durch Deckelbremse

foodpan + rolltop cover mirror polished finish + burner holder, the revolving cover opens gently, thanks to a special built-in axle resistance

Cubeta + tapa rolltop pulido brillante + quemador. Apertura suave de la campana rolltop gracias al freno integrado en el eje

bac + couvercle rolltop poli brillant + brûleur. Le couvercle s'ouvre en douceur grâce au frein intégré dans l'axe

| | ☐ cm | ↑ cm | ltr. |
|---------|------|------|------|
| 12395 3 | Ø 51 | 46 | 6 |

Einzelteile / spare parts / piezas sueltas / pièces détachées

Elektro-Heizelement 200 W - 220 V - 50 Hz, nur für „ROYAL“ Chafer (Nr. 12395)

heating unit 200 W - 220 V - 50 Hz, only for „ROYAL“ Chafer (no. 12395)

resistencia eléctrica 200W-220V-50 Hz., sólo para „ROYAL“ Chafer 12395

résistance électrique 200W - 220V - 50 Hz, uniquement pour chafing „ROYAL“ 12395

12289 5

Speisenbehälter / foodpan / cubeta superior / récipient supérieur

12365 6

Wasserbehälter / waterpan / cubeta baño maría / récipient inférieur

12361 8



Rolltop-Chafing Dish „ROYAL“



Deckelbremse:
sanftes Öffnen des
Rolltop-Deckels durch
eingebauter
Deckelbremse

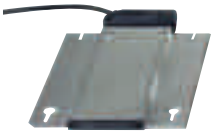

12292

Speisenbehälter GN1/1 65 mm tief + Rolltop-Deckel hochglanzpoliert + 2 Brennpastenbehälter, sanftes Öffnen des Deckels durch Deckelbremse

foodpan GN1/1 65 mm deep + rolltop cover mirror polished finish + 2 burner holders, gentle opening of the lid thanks to a special built-in axle resistance

Cubeta GN 1/1 - 65 mm + tapa rolltop pulido brillante + 2 quemadores. Apertura suave de la campana rolltop gracias al freno integrado en el eje

bac GN 1/1 - 65 mm + couvercle rolltop poli brillant + 2 brûleurs. Le couvercle s'ouvre en douceur grâce au frein intégré dans l'axe

| | cm | cm | ltr. |
|---------|---------|----|------|
| 12358 8 | 66 x 45 | 43 | 9 |

Einzelteile / spare parts / piezas sueltas / pièces détachées

Elektro-Heizelement 600 W - 230 V / heating unit 600 W - 230 V
resistencia eléctrica 600 W - 230 V / résistance électrique 600 W - 230 V

12292 5

Speisenbehälter / foodpan / cubeta superior / bac supérieur

12368 7

Wasserbehälter / waterpan / cubeta baño maría / récipient bain-marie

12362 5



Rolltop-Chafing Dish „ELITE“



poliert, Rolltop-Deckel klappbar auf 90° und 180°, Speisenbehälter GN1/1 65 mm tief + Wasserbecken + 2 Brennpastenbehälter, wechseln des GN-Behälters ohne abnehmen des Deckels (kein Kondenswasser-Rücklaufsystem)

polished, rolltop cover adjustable at 90° and 180°, foodpan GN1/1 65 mm deep + waterpan + 2 burner holders, change of the GN container without removing the lid (condensed water can not be led back into the waterpan)

Pulido brillante, tapa rolltop a 90° o 180°, cubeta GN 1/1 + 2 quemadores, cuba baño maría. Se puede cambiar la cubeta GN sin retirar la tapa. Importante: el agua condensada no revierte en los alimentos

poli brillant, couvercle rolltop ouverture de 90 a 180°, bac GN 1/1, bain-marie, 2 brûleurs. Le bac GN peut être retiré et remplacé sans démonter le couvercle. Important: la condensation ne retombe pas sur les aliments.

| | cm | cm | ltr. |
|---------|---------|----|------|
| 12350 2 | 67 x 47 | 45 | 9 |



stapelbar



Wasserbecken inkl.
Vorrichtung für Heizplatte



12 ltr.

Kaffeedispenser „ROYAL“
coffee dispenser
dispensador de café
distributeur de café



hochglanzpoliert, für warme Getränke, stabil und standfest, inkl. 1 Brennstoffbehälter
mirror polished finish, for warm drinks, solid and stable, incl. 1 burner holder
acabado brillante para bebidas calientes, sólido y estable, incluye un calentador
brillant, pour boissons chaudes, avec 1 brûleur. Robuste et stable.

| | ☐ cm | ↑ cm | ltr. |
|---------|---------|------|------|
| 11667 2 | 28 x 28 | 65 | 12 |



10,5 ltr.

Kaffeedispenser „HAPPY HOUR“
coffee dispenser
dispensador de café
distributeur de café



hochglanzpoliert, für warme Getränke, stabil und standfest, inkl. 1 Brennstoffbehälter
mirror polished finish, for warm drinks, solid and stable, incl. 1 burner holder
acabado pulido brillante para bebidas calientes, sólido y estable, incluye un calentador
brillant, pour boissons chaudes, avec 1 brûleur. Robuste et stable.

| | ☐ cm | ↑ cm | ltr. |
|---------|-----------|------|------|
| 11672 6 | 31 x 33,5 | 54,5 | 10,5 |

Einzelteile / spare parts / piezas sueltas / pièces détachées

Hahn / tap / grifo / robinet

| | | | |
|---------|--|--|--|
| 11671 9 | | | |
|---------|--|--|--|

Heizelement, 500 W, 220 V, einfach in das Gestell des Dispensers legen
heating unit, 500 W, 220 V, insert into the frame of the dispenser
resistencia 500 W 220V, directamente en el pie del dispensador
résistance 500 W 220 V, directement dans le support

| | | | |
|---------|---------|---|--|
| 12287 1 | 21 x 20 | 6 | |
|---------|---------|---|--|



passendes Heizelement
wird in das Gestell eingelegt, regelbar

**HOT
PRICE**



Chafing Dish „ECONOMIC“



Speisenbehälter GN1/1 65mm tief + 2 Brennpastenbehälter + Wasserbecken + Deckel, Gestell mit Deckelhalterung

foodpan GN1/1 65 mm + 2 burner holders + waterpan + cover, frame with coverholder

Cubeta GN 1/1 65 mm + 2 quemadores+ cubeta para el agua + bloqueo para la tapa

1 bac GN 1/1 - 65 mm, 2 brûleurs, 1 bac bain-marie, couvercle, chassis avec blocage couvercle

| | cm | cm | ltr. | |
|---------|---------|----|------|--|
| 11680 1 | 61 x 36 | 30 | 9 | |
| 11680 1 | 61 x 36 | 30 | 9 | ≥ 21 pcs. |
| 11618 4 | 61 x 36 | 30 | | ohne Speisenbehälter without foodpan Sin la cubeta sans le bac GN |

Einzelteile / spare parts / piezas sueltas / pièces détachées

Ersatzdeckel / replacement cover / tapa de recambio / couvercle de rechange

11656 6

**HOT
PRICE**



inkl. 2 x GN1/2 Behälter

Chafing Dish „BUFFET“



2 Speisenbehälter GN1/2 65 mm tief + 2 Brennpastenbehälter + Wasserbecken + Deckel, Gestell mit Deckelhalterung

2 foodpans GN1/2 65 mm deep + 2 burner holders + waterpan + cover, frame with coverholder

2 cubetas GN 1/2 - 65 mm + 2 quemadores+ cubeta para el agua + tapa y bloqueo para la tapa

2 bacs GN 1/2 - 65 mm, 2 brûleurs, 1 bac bain-marie, couvercle, chassis avec blocage couvercle

| | cm | cm | ltr. |
|---------|---------|----|---------|
| 11685 6 | 61 x 36 | 30 | 2 x 3,5 |

**HOT
PRICE**



2x

Chafing Dish „TWIN“, 2er Set



komplette Sets, inkl. GN1/1 Speisenbehälter 65 mm tief

complete sets, incl. GN1/1 foodpan 65 mm deep

2 chafing dish completos con cubetas GN 1/1

2 chafing dish complets avec bacs GN 1/1

| | cm | cm | ltr. | pcs. |
|---------|---------|----|------|------|
| 11699 3 | 61 x 36 | 30 | 9 | 2 |

HOT PRICE

inkl. GN1/1 Behälter

Chafing Dish „CHEF“

Speisenbehälter GN1/1 65 mm tief + 2 Brennpastenbehälter + Wasserbecken + Deckel, Gestell mit Deckelhalterung, langer Hohlgriff

foodpan GN1/1 65 mm + 2 burner holders + waterpan + cover, frame with coverholder

1 cubeta GN 1/1 65 mm, 2 quemadores, cubeta para el agua + tapa y chasis con bloqueo para la tapa

1 bac GN 1/1 - 65 mm, 2 brûleurs, 1 bac bain-marie, couvercle, chassis avec blocage couvercle, poignée tube creux

| | cm | cm | ltr. |
|---------|---------|----|------|
| 11675 7 | 61 x 31 | 30 | 9 |

Einzelteile / spare parts / piezas sueltas / pièces détachées

Ersatzdeckel / replacement cover / tapa de recambio / couvercle de rechange

| |
|---------|
| 11655 9 |
|---------|

HOT PRICE

inkl. 2 x GN1/2 + 1 x GN1/1 Behälter

Chafing Dish Set „CHEF PLUS“

Speisenbehälter GN1/1 65 mm tief + 2 Behälter GN1/2 65 mm tief + 2 Brennpastenbehälter + Wasserbecken + Deckel, Gestell mit Deckelhalterung

foodpan GN1/1 65 mm deep + 2 foodpans GN1/2 65 mm deep + 2 burner holders + waterpan + cover, frame with coverholder

1 cubeta GN 1/1 - 65 mm + 2 cubetas GN 1/2 - 65 mm + 2 quemadores+ 1 cuba baño maría + tapa y marco para sujetar la tapa

1 bac GN 1/1 - 65 mm + 2 bacs GN 1/2 - 65 mm, 2 brûleurs, 1 bac bain-marie, couvercle, chassis avec blocage couvercle

| | cm | cm | ltr. |
|---------|---------|----|------|
| 11686 3 | 61 x 31 | 30 | 9 |

HOT PRICE

11695 ECONOMIC 3,5 ltr.

11692 CHEF 7,5 ltr.

Chafing Dish

Speisenbehälter + Wasserbecken + 1 Brennpastenbehälter + Deckel + Gestell

foodpan + waterpan + 1 burner holder + cover + frame

cubeta redonda + baño maría + quemador + tapa + soporte

récipient + bain-marie + brûleur + couvercle + support

| | cm | cm | ltr. |
|---------|------|----|------|
| 11695 5 | Ø 34 | 26 | 3,5 |
| 11692 4 | Ø 34 | 34 | 7,5 |

| | | |
|-------|-----|--------------------------------|
| 11657 | 3,5 | Ersatzspeisebehälter für 11695 |
| 11658 | 7,5 | Ersatzspeisebehälter für 11692 |



11696 11 ltr.

11678 13,5 ltr.

Hot Pot / Suppentopf

Speisenbehälter + Wasserbecken + 1 Brennpastenbehälter + Deckel + Gestell

foodpan + waterpan + 1 burner holder + cover + frame

cubeta + baño maría + 1 quemador + tapa + soporte

récipient + bain-marie + brûleur + couvercle + support

| | cm | cm | ltr. |
|---------|------|----|------|
| 11696 2 | Ø 30 | 36 | 11,0 |
| 11678 8 | Ø 33 | 35 | 13,5 |



inkl. Vorrichtung für Heizelement

Chafing Dish „CATERER“



Speisenbehälter GN1/1 65 mm tief + 2 Brennpastenbehälter + Wasserbecken inkl. Vorrichtung für Heizelement + Deckel, Gestell mit Deckelhalterung (Lieferung ohne Heizelement)

foodpan GN1/1 65 mm deep + 2 burner holders + 1 waterpan with screws for heating unit + cover, frame with coverholder (without heating unit)

1 cubeta GN 1/1 - 65 mm , 2 quemadores, cuba baño maría con fijaciones para resistencia amovible, estructura con bloqueo tapa (se sirve sin la resistencia)

1 bac GN 1/1 - 65 mm, 2 brûleurs, 1 bac bain-marie avec 4 vis pour fixation d'une résistance de chauffe amovible (non incluse), couvercle, chassis avec blocage couvercle

| | □ cm | ↑ cm | ltr. |
|---------|---------|------|------|
| 12240 6 | 67 x 35 | 35 | 9 |

Einzelteile / spare parts / piezas sueltas / pièces détachées

Ersatzdeckel / replacement cover / tapa de recambio / couvercle de rechange

12260 4

Wasserbecken inkl. Vorrichtung für Heizelement / 1 waterpan / 1 baño maría / bain-marie

12249 9



inkl. Vorrichtung für Heizelement

für bis zu 100 mm tiefe GN-Behälter geeignet

Chafing Dish „CATERER PRO“



Deckel hochglanzpoliert, Deckelgriffe hitzebeständig + 2 Brennpastenbehälter + Wasserbecken, inkl. Vorrichtung für Heizplatte, Gestell mit Deckelhalterung (ohne GN Speisenbehälter)

cover mirror polished finish, cover knob heat-resistant + 2 burner holders + waterpan with screws for heating unit, frame with coverholder (without GN foodpan)

tapa pulido brillante, asas frías, 2 quemadores + cuba inferior con tornillos para resistencia removible (no incluida), tapa y estructura con sujeción de la tapa. (se sirve sin la cubeta GN)

couvercle poli brillant, asas frías, 2 brûleurs, bac bain-marie avec fixations pour résistance amovible (non incluse)

| | □ cm | ↑ cm |
|---------|---------|------|
| 12233 8 | 64 x 35 | 34 |

Einzelteile / spare parts / piezas sueltas / pièces détachées

Ersatzdeckel / replacement cover / tapa de recambio / couvercle de rechange

12236 9

durch umgedrehten Deckel im Wasserbecken sind Chafer rutschfest stapelbar

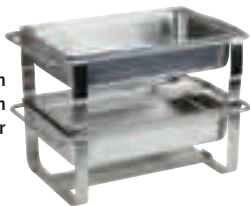

inkl. Vorrichtung für Heizelement

Rolltop-Chafing Dish „CATERER“



Speisenbehälter GN1/1 65 mm tief + Rolltop-Deckel 90° + Wasserbecken inkl. Vorrichtung für Heizplatte + 2 Brennpastenbehälter (Lieferung ohne Heizplatte), massiver Ständer

foodpan GN1/1 65 mm deep + rolltop cover 90° + waterpan with screws for heating unit + 2 burner holders (without heating unit), stable frame

1 cubeta GN 1/1 - 65 mm , campana rolltop abatible a 90°, 2 quemadores, cuba baño maría con fijaciones para resistencia amovible (se sirve sin la resistencia)

1 bac GN 1/1 - 65 mm, couvercle rolltop ouverture 90°, 2 brûleurs, 1 bac bain-marie avec 4 vis pour fixation résistance de chauffe amovible (non incluse)

| | □ cm | ↑ cm | ltr. |
|---------|---------|------|------|
| 12245 1 | 67 x 35 | 45 | 9 |

Einzelteile / spare parts / piezas sueltas / pièces détachées

Wasserbecken inkl. Vorrichtung für Heizelement / 1 waterpan / 1 baño maría / bain-marie

12249 9



inkl. Vorrichtung für Heizelement

Rolltop-Chafing Dish „MAESTRO“



Speisenbehälter GN1/1 65 mm tief (passend auch für 100 mm) + Rolltop-Deckel 90° + Wasserbecken inkl. Vorrichtung für Heizplatte + 2 Brennpastenbehälter

foodpan GN1/1 65 mm (also for 100 mm) + rolltop cover 90° + 1 waterpan with screws for heating unit + 2 burner holders

1 cubeta GN 1/1 - 65 mm (hay espacio para una cubeta 100 mm) , campana rolltop abatible a 90°, 2 quemadores, cuba baño maría con fijaciones para resistencia amovible (se sirve sin la resistencia)

1 bac GN 1/1 - 65 mm (accepte aussi bac ht. 100 mm), couvercle rolltop ouverture 90°, 2 brûleurs, 1 bac bain-marie avec 4 vis pour fixation résistance de chauffe amovible (non incluse)

| | cm | cm | ltr. |
|---------|---------|----|------|
| 12300 7 | 67 x 35 | 45 | 9 |



Besteck-Ablage cutlery rest reposa cuchara pose-cuillère



hochglanzpoliert, ideal für das hygienische Ablegen von Kochlöffeln, Lieferung ohne Löffel

mirror polished finish, ideal for lay down spoon, delivery without spoon

acabado espejo pulido (sin cuchara)

effet brillant (livré sans la cuillère)

| | cm | cm |
|---------|---------|-----|
| 00650 8 | 27 x 11 | 3,5 |



Besteck-Ablage cutlery rest reposa cuchara pose-cuillère



mit rutschfestem Boden

with non-slip bottom

con pies antideslizantes

pieds anti-dérapants

| | cm | cm |
|---------|---------|-----|
| 83897 0 | 26 x 13 | 4,5 |



Wärme-Kies granite chips granulado térmico gravier thermique



für Chafing Dishes, feine Körnung, hohe Wärmespeicherung, kein Verkleben, ideal zum Warmhalten von Eiern

fine for chafing dishes and clean granite chippings, ideal for keeping eggs warm

gravilla de granito limpia fina, ideal para mantener los huevos calientes.

gravier fin de granit, lavé, idéal pour maintenir les oeufs au chaud

| | kg |
|---------|----|
| 81116 4 | 7 |



7 kg Eimer



auf 90° und 180°
klappbar schwere
Ausführung

5 ltr.

Rolltop-Chafing Dish „ELITE“



poliert, Rolltop-Deckel klappbar auf 90° und 180° + Speisenbehälter + Wasserbehälter inkl. Vorrichtung für Heizplatte + 1 Brennpastenbehälter, Hohlgriff kann nicht heiß werden, wechseln des Behälters ohne abnehmen des Deckels (kein Kondenswasser-Rücklaufsystem)

polished, rolltop cover adjustable at 90° and 180° + foodpan + 1 burner holder, waterpan with screws for heating unit (not included), change of the container without removing the lid (condensed water can not be led back into the waterpan)

Pulido brillante, tapa rolltop a 90° o 180°, cubeta GN 1/1 + 2 quemadores, cuba baño maría con fijaciones para resistencia (se sirve sin la resistencia). Se puede cambiar la cubeta GN sin retirar la tapa. Importante: el agua condensada no revierte en los alimentos

poli brillant, couvercle rolltop ouverture de 90 a 180°, bac GN 1/1, bain-marie avec 4 vis pour fixation résistance de chauffe amovible (non incluse), 2 brûleurs. Le bac GN peut être retiré et remplacé sans démonter le couvercle. Important: la condensation ne retombe pas sur les aliments.

| | cm | cm | ltr. |
|---------|------|----|------|
| 12355 7 | Ø 45 | 45 | 5 |



90°
3,5 ltr.

180°

Rolltop-Chafing Dish „HOME“



poliert, Rolltop-Deckel klappbar auf 90° und 180° + Speisenbehälter + Wasserbehälter + Brennpastenbehälter (kein Kondenswasser-Rücklaufsystem)

polished, rolltop cover adjustable at 90° and 180° + foodpan + waterpan + burner holder (condensed water can not be led back into the waterpan)

Pulido brillante, tapa rolltop a 90° o 180°, cubeta + 2 quemadores, cuba baño maría. Importante: el agua condensada no revierte en los alimentos

poli brillant, couvercle rolltop ouverture de 90 a 180°, bac , bain-marie, 2 brûleurs. Important: la condensation ne retombe pas sur les aliments.

| | cm | cm | ltr. |
|---------|------|----|------|
| 12340 3 | Ø 36 | 38 | 3,5 |

Elektro-Rolltop-Chafing Dish „ELITE“ electric rolltop Chafing Dish Chafing Dish eléctrico rolltop chafing dish électrique rolltop



inkl. GN1/1, 100 mm
9 ltr.

poliert, Rolltop-Deckel klappbar auf 90° und 180°, Elektro-Wasserbecken mit Temperaturregelung + Speisenbehälter GN1/1 100 mm tief, 220 - 240 V ~ 50 Hz; 760 - 900 W (kein Kondenswasser-Rücklaufsystem)

polished, rolltop cover adjustable at 90° and 180°, electric waterpan with adjustable heatcontrol + foodpan GN1/1 100 mm deep, voltage 220 - 240 V ~ 50 Hz, power consumption 760 - 900 W (condensed water can not be led back into the waterpan)

pulido brillante, tapa abatible apertura a 90° o 180°, baño maría c/ termostato + cubeta GN 1/1 - 100 mm - 220-240 V-50 Hz. Consumo 760-900 W (el agua condensada no gotea dentro de la cubeta)

poli brillant, couvercle rolltop ouverture à 90° ou 180°, bain-marie électrique avec thermostat + bac GN1/1-100 mm, 220-240 V - 50 Hz; 760-900 W (Important: la condensation ne retombe pas sur les aliments)

| | cm | cm | ltr. |
|---------|---------|----|------|
| 12360 1 | 67 x 47 | 45 | 11 |



6,8 ltr.

Elektro-Rolltop-Chafing Dish „ELITE“
electric rolltop Chafing Dish
Chafing Dish eléctrico rolltop
chafing dish électrique rolltop



poliert, Rolltop-Deckel klappbar auf 90° und 180°, Elektro-Wasserbecken mit Temperaturregelung + Speisenbehälter, 220 - 240 V ~ 50 Hz; 420 - 500 W (kein Kondenswasser-Rücklaufsystem)

polished, rolltop cover adjustable at 90° and 180°, electric waterpan with adjustable heatcontrol + foodpan, voltage 220 - 240 V ~ 50 Hz, power consumption 420 - 500 W (condensed water can not be led back into the waterpan)

pulido brillante, tapa abatible apertura a 90° o 180°, baño maría c/ termostato - 220-240 V-50 Hz. 420-500 W (el agua condensada no gotea dentro de la cubeta)

poli brillant, couvercle rolltop ouverture à 90° ou 180°, bain-marie électrique avec thermostat, 220-240 V - 50 Hz; 420-500 W (Important: la condensation ne retombe pas sur les aliments)

| | □ cm | ↑ cm | ltr. |
|---------|------|------|------|
| 12356 4 | Ø 45 | 45 | 6,8 |

Einzelteile / spare parts / piezas sueltas / pièces détachées

Speisenbehälter / foodpan / cubeta superior / bac supérieur

| |
|---------|
| 12357 1 |
|---------|



9 ltr.

Elektro-Chafing Dish „ECO“ GN1/1
electric Chafing Dish
Chafing Dish eléctrico
chafing dish électrique



Deckel poliert, Elektro-Wasserbecken mit Temperaturregelung + Speisenbehälter GN1/1 65 mm tief, 220 - 240 V ~ 50 Hz; 760 - 900 W

cover polished, electric waterpan with adjustable heatcontrol + foodpan GN1/1 65 mm deep, voltage 220 - 240 V ~ 50 Hz, power consumption 760 - 900 W

tapa pulido brillante, baño maría c/ termostato + cubeta GN 1/1 - 65 mm - 220-240 V-50 Hz. / 760-900 W (el agua condensada no gotea dentro de la cubeta)

couvercle poli brillant, bain-marie électrique avec thermostat + bac GN1/1-65 mm, 220-240 V - 50 Hz; 760-900 W (Important: la condensation ne retombe pas sur les aliments)

| | □ cm | ↑ cm | ltr. |
|---------|---------|------|------|
| 12232 1 | 63 x 36 | 29 | 8,5 |



6,8 ltr.

Elektro-Chafing Dish „ECO“ rund
electric Chafing Dish
Chafing Dish eléctrico
chafing dish électrique



Glasdeckel (Rand poliert), Elektro-Wasserbecken mit Temperaturregelung + Speisenbehälter, 220 - 240 V ~ 50 Hz; 420 - 500 W

cover polished, electric waterpan with adjustable heatcontrol + foodpan, voltage 220 - 240 V ~ 50 Hz, power consumption 420 - 500 W

tapa vidrio borde pulido brillante, baño maría c/ termostato - 220-240 V-50 Hz. 420-500 W (el agua condensada no gotea dentro de la cubeta)

couvercle verre bord poli brillant, bain-marie électrique avec thermostat, 220-240 V - 50 Hz; 420-500 W (Important: la condensation ne retombe pas sur les aliments)

| | □ cm | ↑ cm | ltr. |
|---------|------|------|------|
| 12221 5 | Ø 36 | 25 | 6,8 |



inkl. GN1/1, 100 mm
14 ltr.

Elektro-Chafing Dish „INOXSTAR“
electric-Chafing Dish
Chafing Dish électrique
chafing dish électrique



poliert, Thermostat-Regelung + Speisenbehälter GN1/1 100 mm tief + Deckelhalter, 900 W, 230 V

polished, thermostat control + foodpan GN1/1 100 mm deep + lid holder, 900 W, 230 V

pulido brillante, termostato de control, cubeta GN 1/1-100 mm, bloqueo para la tapa, 900 W, 230 V

poli brillant, thermostat, bac GN 1/1-100 mm, blocage du couvercle, 900 W, 230 V

| | □ cm | ↑ cm | ltr. |
|---------|---------|------|------|
| 12222 2 | 62 x 35 | 29 | 13,5 |



inkl. GN1/1, 65 mm
9 ltr.

Elektro Chafing Dish
electric-Chafing Dish
Chafing Dish électrique
chafing dish électrique



Speisenbehälter GN1/1 65 mm tief + Deckelhalter, Thermostat-Regelung 900 W, 230 V

foodpan GN1/1 65 mm deep + lid holder, thermostat control 900 W, 230 V

cubeta GN 1/1-65 mm, sujeción de la tapa, termostato, 900W, 230 V

bac GN 1/1-65 mm, blocage du couvercle, thermostat, 900W, 230 V

| | □ cm | ↑ cm | ltr. |
|---------|---------|------|------|
| 12225 3 | 63 x 36 | 29 | 9 |

Einzelteile / spare parts / piezas sueltas / pièces détachées

Deckel / cover / Tapa / couvercle

| |
|---------|
| 12235 2 |
|---------|



2 x 4 ltr.

Elektro-Suppenstation
soup warmer
Chafing Dish doble para sopa
chafing dish 2 soupières



2 Suppentöpfe + 2 Suppenkellen + Deckelhalter, Thermostat-Regelung (Überhitzungsschutz) 900 W, 230 V

2 soup pots + 2 soup ladles + lid holder, thermostat control 900 W, 230 V

incluye 2 ollas de sopa + 2 cucharones + bloqueo de la tapa, termostato 900 W, 230 V

2 marmites + 2 louches + blocage du couvercle + thermostat. 900 W / 230 V

| | □ cm | ↑ cm | ltr. |
|---------|-----------|------|-------|
| 12228 4 | 65 x 35,5 | 31 | 2 x 4 |



Rolltop-Deckel „SWISS“
rolltop-cover
campana rolltop
couvercle rolltop



hochglanzpoliert, klappbar auf 90°, nachrüstbar für alle handelsüblichen Chafer

mirror polished finish, cover adjustable at 90°, usable for all commercial chafing dishes

pulido brillante, tapa ajustable 90°, apto para todos los chafings profesionales

poli brillant, ouverture réglable à 90°, apte pour tous les chafings professionnels



| | □ cm | ↑ cm |
|---------|---------|------|
| 12310 6 | 55 x 34 | 19,5 |

NEW

11902



inklusive Schöpfkelle

Elektrischer Suppentopf
electric soup warmer
marmita de sopa eléctrica
marmite à soupe électrique



herausnehmbarer Einsatz aus Edelstahl, elektrisch, mit Wasserbad + Löffel + integrierter Tragering für den Innenbehälter, Deckel mit hitzeisolierendem Griff, Temperaturregelung 80°C (± 10°C), 450-550 W, 230 V

removable soup st. steel pan, bain marie electric, ladle, circular frame, thermostat control till 80°C (± 10°C), 450-550 W, 230 V

recipiente sopa inox extraíble, baño maria eléctrico + cucharón + aro inox, tapa con asas frías, termostato hasta 80°C precisión (± 10°C), 450-550 W, 230 V

réceptif à soupe inox amovible, bain-marie électrique, louche, support circulaire inox, thermostat maxi 80°C (± 10°C), 450-550 W, 230 V

| | □ cm | ↑ cm | ltr. | |
|---------|------|------|------|-------------------|
| 11901 7 | Ø 38 | 36,5 | 10 | ● schwarz / black |
| 11902 4 | Ø 38 | 36,5 | 10 | ● braun / brown |

11901



inklusive Schöpfkelle



Chafing Dish
chafing dish



Bain-Marie Topf
bain marie pot
olla
marmite avec couvercle



inkl. Deckel, mit Löffelaussparung
included cover, notched for spoon
incluye tapa con hueco para la cuchara
inlut le couvercle avec espace pour la louche

| | □ cm | ↑ cm | ltr. |
|---------|------|------|------|
| 12244 4 | Ø 20 | 18 | 4,5 |

Einzelteile / spare parts / piezas sueltas / pièces détachées

Deckel / cover / tapa / couvercle

11244 5



Bain-Marie Deckel
cover for bain marie
tapa GN 1/1 del baño maría
couvercle GN 1/1 du bain-marie



| | □ cm |
|---------|-----------|
| 12243 7 | 54 x 33,5 |

**HOT
PRICE**



Elektrischer Suppentopf „ECONOMIC“
electric soup warmer
marmita de sopa eléctrica
marmite à soupe électrique



Stahl schwarz lackiert, herausnehmbarer Einsatz aus Edelstahl, Temperaturregelung 30°C - 90°C, dreh- und klappbarer Edelstahl-Deckel, inkl. 8 magnetisch haftenden Beschriftungen, 400 W / 230 V

metal, black, removable soup pot, thermostat 30°C - 90°C, st. steel lid, incl. 8 magnetic signs, 400 W / 230 V

metal negro, recipiente sopa inox extraible, termostato 30°C- 90°C, tapa inox, incluye 8 letreros magnéticos, 400 W/ 230 V

acier, noir, récipient à soupe inox amovible, thermostat 30°C - 90°C, couvercle inox, 8 étiquettes magnétiques, 400 W / 230 V

| | ☐ cm | ↑ cm | ltr. |
|---------|------|------|------|
| 11915 4 | Ø 32 | 36 | 9 |

Einzelteile / spare parts / piezas sueltas / pièces détachées

Speisenbehälter / foodpan / recipiente sopa / récipient à soupe

11916 1

Deckel / cover / tapa / couvercle

11917 8

PROFI-QUALITY



Elektrischer Suppentopf „SUNNEX“
electric soup warmer
marmita de sopa eléctrica
marmite à soupe électrique



herausnehmbarer Einsatz aus Edelstahl, elektrisch, mit Wasserbad + Löffel + integrierter Tragering für den Innenbehälter, Deckel mit hitzeisolierendem Griff, Temperaturregelung 80°C ± 10°C

removable soup st. steel pan, bain marie electric, ladle, st. Steel circular frame, thermostat control till 80°C (± 10°C), 220-240 V

recipiente sopa inox extraible, baño maria eléctrico + cucharón + aro inox, tapa con asas frías, termostato hasta 80°C precisión ±10°C , 220-240 V

récipient à soupe inox amovible, bain-marie électrique, louche, support circulaire inox, thermostat maxi 80°C (± 10°C), 220-240 V

| | ☐ cm | ↑ cm | ltr. | |
|---------|------|------|------|-----------------------------|
| 11910 9 | Ø 40 | 37 | 10 | 220 - 240 V, 400 - 450 W |

Einzelteile / spare parts / piezas sueltas / pièces détachées

Edelstahlgefäß / stainless steel pan / Recipiente sopa Inox / récipient à soupe inox

11911 6

10

Edelstahl-Deckel / stainless steel lid / Tapa inox / couvercle inox

11912 3

Elektrokabel / electric cable / cable eléctrico / cable électrique

11913 0

Thermostat / thermostat / termostato / thermostat

11914 7



Brennpastenbehälter
burner holder
quemador
brûleur



| | □ cm | ↑ cm |
|---------|------|------|
| 11683 2 | Ø 9 | 6 |



Sicherheitsbrenner „HOT & SAFE“
refillable burner
quemador recargable
brûleur rechargeable



speziell für den Einsatz von „HOT & SAFE“ Brennflüssigkeit (Pat. Nr. 00108134), für jeden Chafing-Dish geeignet, verbrennt zu 100%, besonders sparsam, minimale Geruchsentwicklung, Brennflüssigkeit kann nicht auslaufen, Brenndauer pro Füllung á 200 ml: 2 bis 2,5 Stunden

A special splash guard prevents any unintentional fuel leakage. An adabter ring allows you to use the burner in any type of chafing dish equipment. Since the new fuel burns cleanly, no soot or smoke is produced. Since more intense heat is generated than with conventional fuel paste, your foods remain hot longer, the fuel is easy to measure, non-toxic. á 200 ml: 2 to 2,5 hours

Muy seguro y sano: borde anti-salpicadura, aro adaptador para cualquier tipo de chafing dish. El combustible se quema de forma limpia, sin humo ni residuos. Ahorro: El calor desprendido es más intenso que con otros combustibles convencionales, manteniendo los platos calientes más tiempo. Fácil de rellenar, no tóxico. 200 ml duran de 2 a 2,5 horas

chaleur saine en toute sécurité. Bord anti-éclaboussures. anneau adaptateur pour tous les types de chafing dish. Le combustible brûle sans émettre ni fumée ni suie. Economique: La chaleur est plus intense qu'avec les autres combustibles conventionnels et maintient donc les plats chauds plus longtemps. Facile à recharger. 200 ml durent de 2 à 2,5 heures

Große Sicherheit,
da Brennflüssigkeit
nicht auslaufen kann.
Unfallsicher!

| | □ cm | ↑ cm |
|---------|------|------|
| 00100 8 | Ø 9 | 6 |



Flasche Brennflüssigkeit
bottle fuel
botella de combustible líquido
bouteille de combustible liquide

| | ltr. |
|---------|------|
| 00208 1 | 1 |



Elektro-Heizelement
heating unit
resistencia
résistance



für mehrheitlich **geschlossene** Chafer GN1/1
 for GN1/1 chafer covers are closed most of the time
 para chafing dish GN 1/1 casi siempre cerrados
 pour chafing dish GN 1/1 qui restent habituellement fermés

12290 1 360 W - 140-250 V



für mehrheitlich **geöffneten** Chafing Dish GN1/1
 for GN1/1 chafer covers open most of the time
 para chafings con la tapa casi siempre abierta
 pour les chafing dont le couvercle reste souvent ouvert

12292 5 600 W - 230 V

für mehrheitlich **geöffnete** Chafer GN1/1 mit **einstellbarem Leistungsregler**
 for GN1/1 chafer covers are opened most of the time, with adjustable control
 para GN 1/1 chafing dish abiertos. Con termostato
 pour chafing dish GN 1/1 qui restent habituellement ouverts, avec thermostat

12294 9 800 W - 230 V

Elektro-Heizelement 200 W - 220 V - 50 Hz, nur für „ROYAL“ Chafer (Nr. 12395)
 heating unit 200 W - 220 V - 50 Hz, only for „ROYAL“ Chafer (no. 12395)
 resistencia eléctrica 200W-220V-50 Hz., sólo para „ROYAL“ Chafer 12395
 résistance électrique 200W - 220V -50 Hz, uniquement pour chafing „ROYAL“ 12395

12289 5 200 W - 220 V - 50 Hz



für Kaffeedispenser (Nr. 11672)
 for coffee dispenser (no. 11672)
 para dispensador de café (11672)
 pour distributeur à café (11672)

12287 1 500 W - 220 V



Einbau-Induktionskochplatte für Chafing Dish
built-in induction plate for chafing dish
placa de inducción para empotrar
plaque à induction à encastrer



inkl. Kabel-Fernbedienung, energiesparend
 plug EU, voltage 230 VAC,
 enchufe EU, voltaje 230 VAC
 prise Europe, voltage 230 VAC

| | | | |
|---------|-------------|------|--------|
| | ▣ cm | ↑ cm | |
| 12285 7 | 35,5 x 35,5 | 6 | 2000 W |



Induktionskochplatte für Chafing Dish
induction plate for chafing dish
placa de inducción para chafing dish
plaque à induction pour chafing dish



CE
SCHOTT
 glass made of ideas

mit Regler, kann nur in Verbindung mit passendem Metallrahmen genutzt werden
 with power control, can only be used with the fitting frame for induction plate
 con control de potencia, sólo puede usarse con el marco para placa de inducción
 avec régulateur. A utiliser obligatoirement avec le cadre support inox

| | | |
|---------|------|-------|
| | cm | |
| 12295 6 | Ø 24 | 900 W |

Metallrahmen für Induktionskochplatte
frame for induction plate
estructura o marco para placa de inducción
cadre support inox pour plaque induction



für GN1/1 Chafing Dish / for GN1/1 chafing dish
 para GN 1/1 chafing dish / pour chafing GN 1/1

| |
|---------|
| 12296 3 |
|---------|

für Chafer rund, Suppenkugel / for chafing dish, round
 Para chafing dish redondo / pour chafing dish rond

| |
|---------|
| 12291 8 |
|---------|

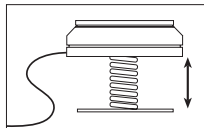

Mobile Chafing Dish Heizung
heating element
resistencia
résistance

EDELSTAHL
 STAINLESS
 INOX



für alle marktgängigen Chafing Dishes, die Heizplatte wird durch eine Spiralfeder an das Wasserbad gedrückt

suitable for all current popular chafing dishes, with special spring

para todos los chafing dish más corrientes.

pour la plupart des chafing dish les plus courants

| | | |
|---------|----|--------|
| | cm | ↑ cm |
| 12299 4 | 14 | 9 - 11 |

Hot Plate „ECONOMIC“
hot plate
placa caliente
plaque chaude

ALU
 ALUMINIUM



automatische Temperaturregelung, die Alu-Heizplatte ist in ca. 5 Minuten auf ca. 75°C erhitzt und hält Speisen auf konstanter Temperatur, CE-Zeichen

with automatic power supply, gets up to 75°C in 5 minutes, keeps food on continuous temperature

control automático de temperatura, mantiene los alimentos en temperatura constante. La placa de aluminio llega a 75° en aprox. 5min.

contrôle automatique de température, maintient les aliments à température constante sur la plaque aluminium. Montée à 75°C en 5 min. approx.

| | | |
|---------|-----------|-----|
| | cm | GN |
| 11920 8 | 53 x 32,5 | 1/1 |



Wärme-Kies
granite chips
granulado térmico
gravier thermique

für Chafing Dishes, feine Körnung, hohe Wärmespeicherung, kein Verkleben, ideal zum Warmhalten von Eiern

fine for chafing dishes and clean granite chippings, ideal for keeping eggs warm

gravilla de granito limpia fina, ideal para mantener los huevos calientes.

gravier fin de granit, lavé, idéal pour maintenir les oeufs au chaud

kg

81116 4

7



7 kg Eimer

Chafing Dish „VEGGIE“



Speisenbehälter + Wasserbecken + 1 Brennpastenbehälter + Deckel + Gestell

foodpan + waterpan + 1 burner holder + cover + frame

cubeta redonda + baño maría + quemador + tapa + soporte

réipient + bain marie + brûleur + couvercle + support



4 Liter

| | cm | cm | ltr. |
|---------|------|----|------|
| 11693 1 | Ø 35 | 28 | 4 |



Glasdeckel
 glass cover



praktischer Halter
 für den Deckel
 included cover holder



Servierschale „FEUERZANGENBOWLE“
warmer
calentador para quemada
chauffe-plat spécial sucre flambé



Stövchen verchromt, Edelstahl-Deckel hochglanzpoliert, Kelle und Zuckerhutablage aus Edelstahl, ohne Zuckerhut

frame chrome plated, stainless cover mirror polished finish, incl. ladle and sugar holder especial para preparar bebidas calientes, con azúcar o quemadas, redondo, pie cromado, incluye cucharón y soporte para el bloque de azúcar.

spécial pour la préparation de boissons chaudes de type „quemadas“. Pied chromé, inclut la louche et le support à sucre.

| | cm | cm | ltr. |
|---------|------|----|------|
| 65065 7 | Ø 23 | 26 | 4 |



Feuerzange / fire tong / soporte para quemada / support pour à flamber

| | |
|---------|--------|
| 65066 4 | 31 x 7 |
|---------|--------|



**Servierschale mit Stövchen „HOT POT“
warmer
calienta platos
chauffe-plat**



Stövchen verchromt, Edelstahl-Deckel hochglanzpoliert, inkl. Schöpfkelle
frame chrome plated, stainless cover mirror polished finish, incl. ladle
cacerola de vidrio termoresistente, soporte cromado, tapa con pulido brillante, apto para horno
bol en verre thermo-résistant, pied chromé, couvercle brillant, apte pour cuisson au four

| | □ cm | ↑ cm | ltr. |
|---------|------|------|------|
| 65035 0 | Ø 23 | 26 | 4 |

Einzelteile / spare parts / piezas sueltas / pièces détachées

| | | | |
|--|--|--|---|
| Ersatz-Glaseinsatz / spare glass / fuente de recambio vidrio / plat de rechange en verre | | | |
| 64201 0 | | | 4 |



65010

**Servierschale mit Stövchen
warmer
calienta platos
chauffe-plat**



feuerfeste Glasschale, Stövchen verchromt, Deckel hochglanzpoliert, Backofen geeignet
glas bowl fireproof, frame chrome plated, cover mirror polished finish, suitable for oven
fuente de vidrio termoresistente, soporte cromado, tapa con pulido brillante, apto para horno
plat en verre thermo-résistant, pied chromé, couvercle brillant, apte pour cuisson au four

| | □ cm | ↑ cm | ltr. |
|---------|---------|------|---------|
| 65010 7 | 47 x 24 | 13 | 3 |
| 65020 6 | 44 x 25 | 13 | 3 |
| 65030 5 | 45 x 29 | 12 | 2 x 1,5 |

Einzelteile / spare parts / piezas sueltas / pièces détachées

| | | | |
|--|------------------------|--|-----|
| Ersatz-Glaseinsatz / spare glass / fuente de recambio vidrio / plat de rechange en verre | | | |
| 64001 6 | für / for / para 65010 | | 3 |
| 64051 1 | für / for / para 65020 | | 3 |
| 64151 8 | für / for / para 65030 | | 1,5 |



65020



65030



65033

**Servierschale mit Stövchen
warmer
calienta platos
chauffe-plat**



feuerfeste Glasschale, Stövchen verchromt, Deckel hochglanzpoliert, Backofen geeignet
glas bowl fireproof, frame chrome plated, cover mirror polished finish, suitable for oven
fuente de vidrio termoresistente, soporte cromado, tapa con pulido brillante, apto para horno
plat en verre thermo-résistant, pied chromé, couvercle brillant, apte pour cuisson au four

| | □ cm | ↑ cm | ltr. |
|---------|-----------|------|------|
| 65033 6 | Ø 26 | 22 | 2 |
| 65034 3 | 29,5 x 18 | 12 | 1,5 |



65034

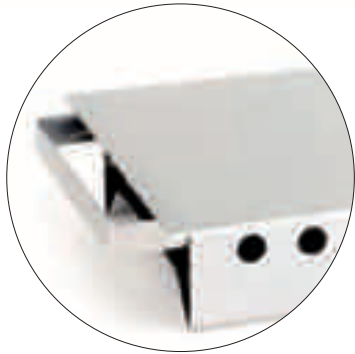

Speisenwärmer „PROFI“
plate warmer
calienta platos
chauffe-plat



Rahmen aus Edelstahl mit Aluminium-Wärmeplatte
 stainless steel frame, thick aluminium plate
 soporte inox con placa de aluminio
 support inox avec plaque aluminium

| | ▣ cm | ↑ cm | |
|---------|---------|------|---|
| 35050 2 | 33 x 18 | 7 | 2 Teelichter / 2 tealights 2 velas / 2 bougies |
| 35070 0 | 45 x 18 | 7 | 3 Teelichter / 3 tealights 3 velas / 3 bougies |

HOT PRICE

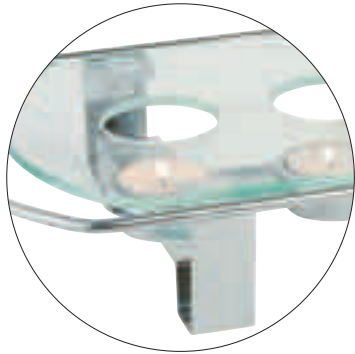
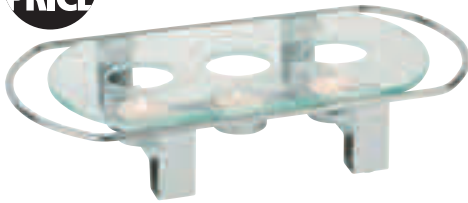

Speisenwärmer
warmer
calienta platos
chauffe-plat



3-flammig
 3 lights
 3 velas
 3 bougies

| | ▣ cm | ↑ cm |
|---------|---------|------|
| 35065 6 | 34 x 18 | 6 |

HOT PRICE

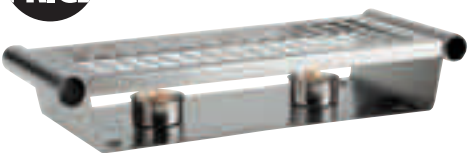

Speisenwärmer
warmer
calienta platos
chauffe-plat



2-flammig, matt poliert
 2 lights, satin polished finish
 2 velas, acero inoxidable acabado mate
 2 bougies, inox finition mate

| | ▣ cm | ↑ cm |
|---------|---------|------|
| 35343 5 | 34 x 13 | 6 |

GN . GN-Zubehör . GN-Behälter . Transport . Vorrat . Thermobox
GN . GN-extras . GN-container . transport . store . thermobox
GN . GN-extras . GN-cubeta . transporte y almacenaje . thermobox
bacs et accessoires GN . transport et stockage . thermobox

GN-Behälter Größen nach EN 631

Alle Behälter sind aus rostfreiem Chrom-Nickel-Edelstahl mit elektrolytisch polierter (seidenmatt) Oberfläche und somit perfekt geeignet für professionellen Einsatz.

GN-container according to EN 631

All pans are made of chrome/nickel stainless steel with a surface polished by electrolysis (satin-matt) and therefore highly suitable for professional operation.

De conformidad con la norma europea EN 631

Todos los contenedores están fabricados en acero inoxidable cromado/niquelado con su superficie (satinada) pulida por electrolisis lo que la hace altamente apropiado para el uso profesional.

Bacs GN- Conforme à la norme EN 631

Tous les bacs sont fabriqués en inox/chrome/nickel, surface polie électrolythique (satiné)- Approprié pour usage professionnel.

Vorteile der rundgeprägten U-Ecken:

- erhöhte Stabilität durch verstärktes Profil
- zielgerechtes und sauberes Ausgießen
- genaue Positionierung der GN-Behälter
- superleichtes Stapeln und Entstapeln
- kein Verklemmen der GN-Behälter
- hohe Stoßfestigkeit durch robuste Konstruktion
- ansprechendes Design und stilvoller Blickfang

Advantages of the round-shaped U-Corners:

- increased stability due to the unique construction
- clean ladling and pouring
- exact positioning of the containers
- improved shock-resistance
- appealing design
- no seize of the containers

Ventajas de las esquinas en U:

Perfil reforzado que confiere mayor rigidez y resistencia a la cubeta, diseño para verter fácil y limpiamente, fáciles de apilar y desapilar sin que se claven entre sí, construcción más robusta y resistente a las golpes mecánicos, diseño elegante.

Avantages et fonctionnalité des angles en U:

Profil renforcé pour une meilleure consistance et rigidité du récipient, design qui facilite un versage propre et aisé, permet un empilage et déempilage faciles sans que les bacs restent coincés, meilleure résistance aux chocs mécaniques, seign élégant.

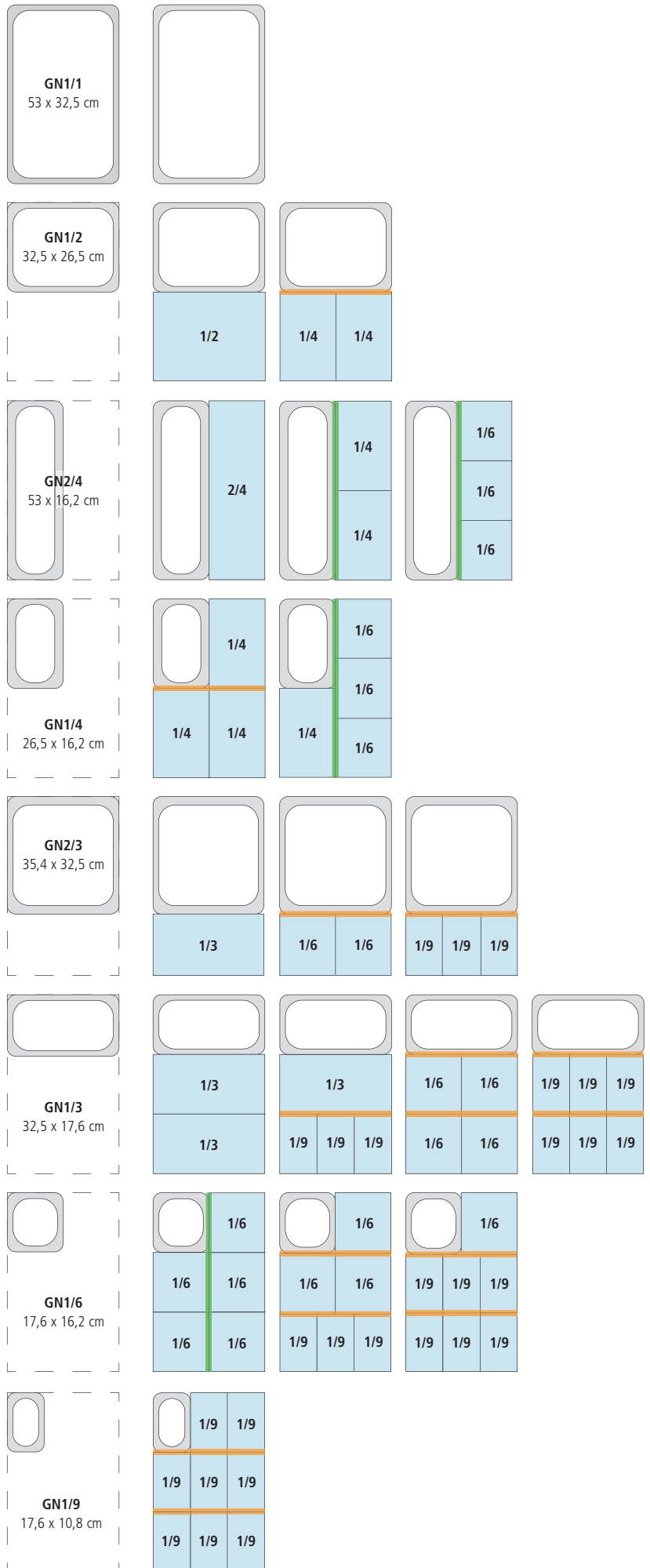

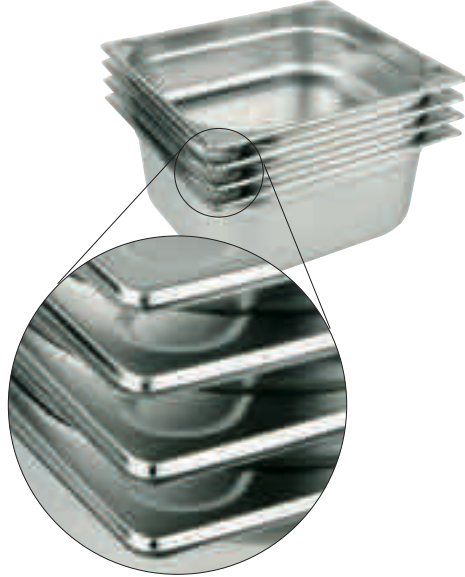

GastroNorm-Behälter
gastronorm-container
cubetas gastronorm
bacs gastronomie



| | GN | ↓ mm | litr. |
|---------|-----|------|-------|
| 81000 6 | 2/1 | 20 | 5,0 |
| 81095 2 | 1/1 | 10 | 1,25 |
| 81100 3 | 1/1 | 20 | 2,5 |
| 81101 0 | 1/1 | 40 | 5,0 |
| 81109 6 | 1/1 | 55 | 6,5 |
| 81102 7 | 1/1 | 65 | 9,0 |
| 81104 1 | 1/1 | 100 | 14,0 |
| 81106 5 | 1/1 | 150 | 21,0 |
| 81108 9 | 1/1 | 200 | 28,0 |
| 81200 0 | 1/2 | 20 | 1,0 |
| 81201 7 | 1/2 | 40 | 2,0 |
| 81209 3 | 1/2 | 55 | 2,8 |
| 81202 4 | 1/2 | 65 | 4,0 |
| 81204 8 | 1/2 | 100 | 6,5 |
| 81206 2 | 1/2 | 150 | 9,5 |
| 81208 6 | 1/2 | 200 | 12,5 |
| 81300 7 | 1/3 | 20 | 0,75 |
| 81302 1 | 1/3 | 65 | 2,5 |
| 81304 5 | 1/3 | 100 | 4,0 |
| 81306 9 | 1/3 | 150 | 5,7 |
| 81308 3 | 1/3 | 200 | 7,8 |
| 81400 4 | 1/4 | 20 | 0,5 |
| 81401 1 | 1/4 | 40 | 1,0 |
| 81402 8 | 1/4 | 65 | 1,8 |
| 81404 2 | 1/4 | 100 | 2,8 |
| 81406 6 | 1/4 | 150 | 4,0 |
| 81408 0 | 1/4 | 200 | 5,5 |
| 81602 2 | 1/6 | 65 | 1,0 |
| 81604 6 | 1/6 | 100 | 1,6 |
| 81606 0 | 1/6 | 150 | 2,4 |
| 81608 4 | 1/6 | 200 | 3,4 |
| 81502 5 | 1/9 | 65 | 0,6 |
| 81504 9 | 1/9 | 100 | 1,0 |
| 81506 3 | 1/9 | 150 | 1,5 |
| 81700 5 | 2/3 | 20 | 1,5 |
| 81701 2 | 2/3 | 40 | 3,0 |
| 81702 9 | 2/3 | 65 | 5,5 |
| 81704 3 | 2/3 | 100 | 9,0 |
| 81706 7 | 2/3 | 150 | 13,0 |
| 81707 4 | 2/3 | 200 | 18,0 |
| 81800 2 | 2/4 | 20 | 1,2 |
| 81801 9 | 2/4 | 40 | 2,4 |
| 81802 6 | 2/4 | 65 | 3,6 |
| 81804 0 | 2/4 | 100 | 5,6 |
| 81806 4 | 2/4 | 150 | 8,7 |

Vorteile der rundgeprägten U-Ecken:

- erhöhte Stabilität durch verstärktes Profil
- zielgerechtes und sauberes Ausgießen
- genaue Positionierung der GN-Behälter
- superleichtes Stapeln und Entstapeln
- kein Verkleben der GN-Behälter
- hohe Stoßfestigkeit durch robuste Konstruktion
- ansprechendes Design und stilvoller Blickfang

Advantages of the round-shaped U-Corners:

- increased stability due to the unique construction
- clean ladling and pouring
- exact positioning of the containers
- improved shock-resistance
- appealing design
- no seize of the containers

EN 631 Gastronorm  cm

| | |
|--------|-------------|
| GN 2/1 | 53,0 x 65,0 |
| GN 1/1 | 53,0 x 32,5 |
| GN 1/2 | 32,5 x 26,5 |
| GN 1/3 | 32,5 x 17,6 |
| GN 1/4 | 26,5 x 16,2 |
| GN 1/6 | 17,6 x 16,2 |
| GN 1/9 | 17,6 x 10,8 |
| GN 2/3 | 35,4 x 32,5 |
| GN 2/4 | 53,0 x 16,2 |



perforierte GN-Behälter
perforated GN-container
cubetas GN perforado
bacs GN perforés



| | GN | ↓ mm |
|---------|-----|------|
| 81911 5 | 1/1 | 40 |
| 81907 8 | 1/1 | 65 |
| 81908 5 | 1/1 | 100 |
| 81909 2 | 1/1 | 150 |
| 81910 8 | 1/1 | 200 |
| 81901 6 | 1/2 | 65 |
| 81902 3 | 1/2 | 100 |
| 81903 0 | 1/2 | 150 |
| 81904 7 | 1/2 | 200 |
| 81905 4 | 2/3 | 65 |
| 81906 1 | 2/3 | 100 |



GN-Deckel
GN-lids
tapas GN
couvercles GN



ohne Löffelaussparung
 without notched edge for spoons
 sin agujero para cucharón
 sans espace pour louche

| | GN |
|---------|-----|
| 81195 9 | 1/1 |
| 81295 6 | 1/2 |
| 81395 3 | 1/3 |
| 81495 0 | 1/4 |
| 81695 4 | 1/6 |
| 81591 9 | 1/9 |
| 81795 1 | 2/3 |
| 81895 8 | 2/4 |

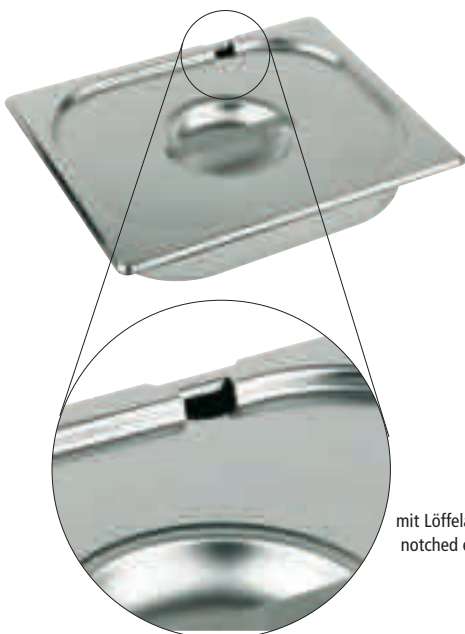

mit Löffelaussparung
 with notched edge for spoons
 con agujero para cucharón
 avec espace pour louche

| | |
|---------|-----|
| 81191 1 | 1/1 |
| 81292 5 | 1/2 |
| 81391 5 | 1/3 |
| 81492 9 | 1/4 |
| 81692 3 | 1/6 |
| 81595 7 | 1/9 |
| 81791 3 | 2/3 |
| 81891 0 | 2/4 |

mit Löffelaussparung with
 notched edge for spoons



Adapter / Zwischensteg
adapter
adaptador
adaptateur



Schiene ermöglicht stabilen Halt von GN-Behältern im Chafing Dish, rostfreier Chrom-Nickel-Edelstahl
 for fixing GN pans, chrome / nickel stainless steel
 para sujetar las cubetas GN, acero inox
 support stable pour les bacs GN

| | cm | |
|---------|------|---|
| 81997 9 | 17,6 | längs bei GN 1/9 / lengthwise GN 1/9 longitud GN 1/9 / GN 1/9 dans la longueur |
| 81999 3 | 32,5 | quer bei GN 1/2 / crosswise GN 1/2 de ancho GN 1/2 / GN 1/2 dans la largeur |
| 81998 6 | 53 | längs bei GN 1/1 / lengthwise GN 1/1 longitud GN 1/1 / GN 1/1 dans la longueur |



GN Steck-Deckel
GN-lid with silicone seal
tapa GN hermética con junta
couvercle GN hermétique avec joint



schwappsicherer Deckel

nicht für Kombidämpfer geeignet!

Silikondichtung, Griffmulde und Loch gegen Unterdruck, nicht für Kombidämpfer geeignet, nicht für ≤ 65 mm tiefe GN-Behälter
 silicone joint, flat handle, vent to compensate for pressure, not usable for steam oven, not usable for ≤ 65 mm depth GN-pans

junta de silicona, asa empotrada, válvula para compensar la presión, no se puede utilizar en hornos de vapor, ni para cubetas de altura ≤ 65 mm

joint silicone, anse encastrée, valve pour compenser la pression. Ne pas utiliser pour les fours à vapeur ni pour les bacs hauteur ≤ 65 mm

| | GN |
|---------|-----|
| 80023 6 | 1/1 |
| 80024 3 | 1/2 |
| 80025 0 | 1/3 |
| 80026 7 | 1/4 |
| 80027 4 | 1/6 |



runder ergonomischer Griff

mit Fallgriff



in 3 Tiefen erhältlich
 65, 100 und 150 mm

GN-Behälter mit Fallgriff
GN-pans with falling handles
GN cubetas con asas abatibles
bacs GN avec anses abattantes



runder ergonomischer Fallgriff
 round ergonomic handles
 asas redondeadas ergonómicas
 anses ergonomiques arrondies

| | GN | ↓ mm | ltr. |
|---------|-----|------|------|
| 82502 4 | 1/1 | 65 | 9 |
| 82504 8 | 1/1 | 100 | 14 |
| 82506 2 | 1/1 | 150 | 21 |
| 82508 6 | 1/2 | 65 | 4 |
| 82510 9 | 1/2 | 100 | 6,5 |
| 82512 3 | 1/2 | 150 | 9,5 |
| 82514 7 | 1/3 | 65 | 2,5 |
| 82516 1 | 1/3 | 100 | 4 |
| 82518 5 | 1/3 | 150 | 5,7 |
| 82520 8 | 2/3 | 65 | 5,5 |
| 82522 2 | 2/3 | 100 | 9 |
| 82524 6 | 2/3 | 150 | 13 |

GN-Deckel mit Ausschnitt passend zu
GN-Behältern mit Fallgriff.



GN-Deckel mit Ausschnitt
GN-lid with cut out
tapa para GN cubetas
couvercle pour bacs GN



| | GN |
|---------|-----|
| 82526 0 | 1/1 |
| 82528 4 | 1/2 |
| 82530 7 | 1/3 |
| 82532 1 | 2/3 |



GN-Deckel, luftdicht
GN-cover, airtight
tapa GN hermética
couvercle hermétique GN



temperaturbeständig -40°C bis +95°C
temperature resistance from -40°C up to +95°C
resistente a temperaturas entre - 40°C hasta + 95°C
apte pour température entre - 40°C et + 95°C

| | GN |
|---------|-----|
| 80021 2 | 1/1 |
| 80022 9 | 1/2 |

GN1/1
und
GN1/2

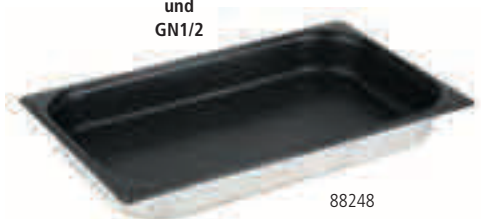

88248

Antihaft GN-Konvektomatenblech
GN-convection oven trays - non stick
Cubeta GN antiadherente para hornos de convección
bac GN anti-adhérent pour fours à convection



Oberfläche mit schwarzer Antihaftbeschichtung, schwere Qualität
coated black non stick, heavy quality
interior con revestimiento antiadherente negro, alta calidad
revêtement intérieur anti-adhérent noir, haute qualité

| | GN | cm | ↑ cm |
|---------|-----|-------------|------|
| 88246 1 | 1/1 | 53,0 x 32,5 | 2 |
| 88247 8 | 1/1 | 53,0 x 32,5 | 4 |
| 88248 5 | 1/1 | 53,0 x 32,5 | 6,5 |
| 88249 2 | 1/2 | 26,5 x 32,5 | 1 |
| 88250 8 | 1/2 | 26,5 x 32,5 | 2 |

GN1/1

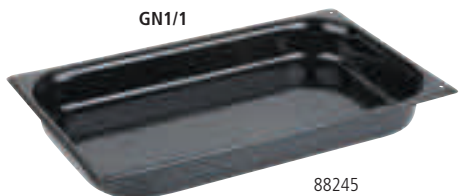

88245

GN-Konvektomatenblech - Emailliert
GN-convection oven trays - enamelled
cubeta GN esmaltada para hornos de convección
bac GN émaillé pour fours à convection



beidseitig beschichtet mit schwarzer Granit-Emaille, gelochte Ecken, schwere Qualität
both sides coated with black granite enamel, perforated rim corners, heavy gauge
chapa de hierro esmaltada por ambas caras, color granito negro, borde con ángulos perforados, alta calidad.
plaque acier émaillé intérieur et extérieur, granité noir, bord perforé dans les angles, qualité renforcée

| | GN | cm | ↑ cm |
|---------|-----|-----------|------|
| 88244 7 | 1/1 | 53 x 32,5 | 2 |
| 88144 0 | 1/1 | 53 x 32,5 | 4 |
| 88245 4 | 1/1 | 53 x 32,5 | 6,5 |

Backblech
baking sheet
placa pastelera
plaque à pâtisserie

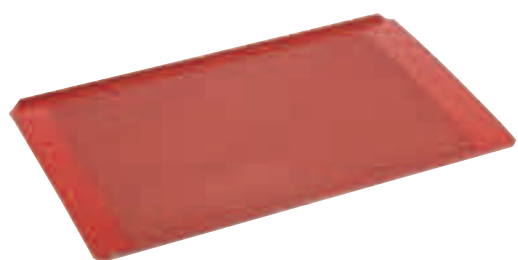

gelocht Ø 3 mm, Materialstärke 1,5 mm, Silikon beschichtet, temperaturbeständig bis 240°C
perforated Ø 3 mm, coated with silicon, heat resistant up to 240°C
aluminio con revestimiento de silicona perforada, resistente hasta 240°
aluminium avec revêtement silicone, perforée, température maxi 240°

| | GN | cm |
|---------|-----|-----------|
| 88285 0 | 1/1 | 53 x 32,5 |



GN-Roste
GN-grid
rejilla GN
grille inox

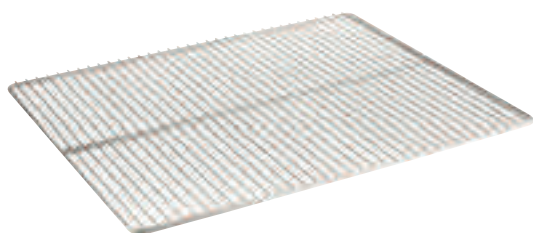

elektrolytisch poliert, Drahtstärke 3 mm, Rahmendraht 6 mm, extra schwere Qualität
electro-polished, wire thickness 3 mm, frame wire 6 mm, extra heavy quality
inox pulido electrolítico , grosor alambre 3 mm, grosor marco 6 mm, calidad reforzada.
inox poli électrolytique, fil 3 mm, cadre 6 mm, qualité renforcée

| | GN | cm |
|---------|-----|-------------|
| 81199 7 | 2/1 | 65,0 x 53,0 |
| 81198 0 | 1/1 | 53,0 x 32,5 |
| 81296 3 | 1/2 | 32,5 x 26,5 |
| 81796 8 | 2/3 | 32,5 x 35,4 |

Bestecksammler GN1/3
container GN1/3
cubeta GN 1/3
bac GN 1/3



mit 2 Haken zum Einhängen an Servier- oder Transportwagen
container with 2 hooks, to hang on trolleys for cutlery
cubeta con 2 ganchos para cubiertos, a colgar del carro
bac à couverts avec 2 crochets, à accrocher au chariot

| | GN | cm | ↑ cm |
|---------|-----|-------------|------|
| 11978 9 | 1/3 | 32,5 x 17,5 | 15 |

GN-Behälter aus Polycarbonat
GN-container polycarbonate
cubeta GN policarbonato
bac GN polycarbonate



transparent: Inhalt gut erkennbar, Skalierung in Liter, robust und formstabil
 transparent: content can be seen, liter scale, solid quality
 transparente para ver el contenido, graduación en litros, alta calidad
 transparent pour voir le contenu, graduation en litres, haute-qualité

| | GN | ↓ mm | ltr. |
|--------------------|-----|------|------|
| 82004 3 | 1/1 | 65 | 8,5 |
| 82006 7 | 1/1 | 100 | 13,0 |
| 82008 1 | 1/1 | 150 | 19,5 |
| 82010 4 | 1/1 | 200 | 26,0 |
| 82012 8 | 1/2 | 65 | 3,9 |
| 82014 2 | 1/2 | 100 | 5,9 |
| 82016 6 | 1/2 | 150 | 8,9 |
| NEW 82017 3 | 1/2 | 200 | 11,8 |
| 82018 0 | 1/3 | 65 | 2,4 |
| 82020 3 | 1/3 | 100 | 3,6 |
| 82022 7 | 1/3 | 150 | 5,3 |
| 82023 4 | 1/3 | 200 | 7,0 |
| 82028 9 | 1/4 | 65 | 1,7 |
| 82030 2 | 1/4 | 100 | 2,5 |
| 82032 6 | 1/4 | 150 | 3,7 |
| NEW 82034 0 | 1/4 | 200 | 5,5 |
| 82036 4 | 1/6 | 65 | 1,0 |
| 82038 8 | 1/6 | 100 | 1,5 |
| 82040 1 | 1/6 | 150 | 2,2 |
| NEW 82042 5 | 1/6 | 200 | 3,4 |
| 82050 0 | 1/9 | 65 | 0,6 |
| 82051 7 | 1/9 | 100 | 1,0 |

EN 631 Gastronorm cm

| | |
|--------|-------------|
| GN 1/1 | 53,0 x 32,5 |
| GN 1/2 | 32,5 x 26,5 |
| GN 1/3 | 32,5 x 17,6 |
| GN 1/4 | 26,5 x 16,2 |
| GN 1/6 | 17,6 x 16,2 |
| GN 1/9 | 17,6 x 10,8 |

GN-Deckel
GN-lid
tapa GN
couverture GN



| | GN |
|---------|-----|
| 82001 2 | 1/1 |
| 82013 5 | 1/2 |
| 82019 7 | 1/3 |
| 82029 6 | 1/4 |
| 82037 1 | 1/6 |
| 82059 3 | 1/9 |

GN-Abtropfgitter
GN-drainer
escurridor GN
égouttoir GN



| | GN |
|---------|-----|
| 82003 6 | 1/1 |
| 82005 0 | 1/2 |
| 82007 4 | 1/3 |



82117



GN-Behälter aus Polypropylen
GN-container polypropylene
Cubetas GN polipropileno
bacs GN en polypropilène



milchig (nicht transparent), Skalierung in Liter, robust und formstabil

frosted, Liter scale, solid quality

Translúcido opaco, graduación en litros, muy resistente a la deformación, robusto

Translucide opaque, graduation en litres, très résistant à la déformation, robuste

| | GN | ↓ mm | ltr. |
|--------------------|-----|------|------|
| NEW 82104 0 | 1/1 | 65 | 8,5 |
| NEW 82106 4 | 1/1 | 100 | 13,0 |
| 82108 8 | 1/1 | 150 | 19,5 |
| 82110 1 | 1/1 | 200 | 26,0 |
| NEW 82112 5 | 1/2 | 65 | 3,9 |
| NEW 82114 9 | 1/2 | 100 | 5,9 |
| 82116 3 | 1/2 | 150 | 8,9 |
| 82117 0 | 1/2 | 200 | 11,8 |
| NEW 82118 7 | 1/3 | 65 | 2,4 |
| NEW 82120 0 | 1/3 | 100 | 3,6 |
| 82122 4 | 1/3 | 150 | 5,3 |
| 82123 1 | 1/3 | 200 | 7,0 |
| 82128 6 | 1/4 | 65 | 1,7 |
| 82130 9 | 1/4 | 100 | 2,5 |
| 82132 3 | 1/4 | 150 | 3,7 |
| 82134 7 | 1/4 | 200 | 5,5 |
| 32136 1 | 1/6 | 65 | 1,0 |
| 82138 5 | 1/6 | 100 | 1,5 |
| 82140 8 | 1/6 | 150 | 2,2 |
| 82142 2 | 1/6 | 200 | 3,4 |
| NEW 82150 7 | 1/9 | 65 | 0,6 |
| NEW 82151 4 | 1/9 | 100 | 1,0 |

GN-Behältern aus Polypropylen
sind auch stapelbar mit
APS GN-Behältern aus Polycarbonat



82113
GN 1/2

GN-Deckel
GN-lid
tapa GN
couvercle GN



| | GN |
|--------------------|-----|
| 82101 9 | 1/1 |
| 82113 2 | 1/2 |
| 82119 4 | 1/3 |
| 82129 3 | 1/4 |
| 82137 8 | 1/6 |
| NEW 82159 0 | 1/9 |

**HOT
PRICE**

GN-Behälter „ECO-LINE“
GN container
GN cubeta superior
GN bac supérieur



Melamin



GN1/1
 83759 65 mm
 84300 100 mm



GN1/2
 83756 65 mm
 84307 100 mm



GN2/4
 83755 65 mm
 84302 100 mm



GN1/3
 83752 65 mm
 84303 100 mm



GN1/4
 83751 65 mm
 84304 100 mm



GN1/6
 83748 65 mm
 84311 100 mm

mit Stapelnocke
 with notching edge
 con borde marcado para el apilado
 avec rebord pour l'empilage

| | GN | ↓ mm | ltr. | □ cm | |
|---------|-----|------|------|-------------|---|
| 83759 1 | 1/1 | 65 | 7,10 | 53,0 x 32,5 | ○ |
| 83757 7 | 1/2 | 65 | 3,40 | 32,5 x 26,5 | ○ |
| 83755 3 | 2/4 | 65 | 3,00 | 53,0 x 16,2 | ○ |
| 83753 9 | 1/3 | 65 | 2,00 | 32,5 x 17,6 | ○ |
| 83751 5 | 1/4 | 65 | 1,35 | 26,5 x 16,2 | ○ |
| 83749 2 | 1/6 | 65 | 0,80 | 17,6 x 16,2 | ○ |
| 83758 4 | 1/1 | 65 | 7,10 | 53,0 x 32,5 | ● |
| 83756 0 | 1/2 | 65 | 3,40 | 32,5 x 26,5 | ● |
| 83754 6 | 2/4 | 65 | 3,00 | 53,0 x 16,2 | ● |
| 83752 2 | 1/3 | 65 | 2,00 | 32,5 x 17,6 | ● |
| 83750 8 | 1/4 | 65 | 1,35 | 26,5 x 16,2 | ● |
| 83748 5 | 1/6 | 65 | 0,80 | 17,6 x 16,2 | ● |
| 84300 4 | 1/1 | 100 | 10,6 | 53,0 x 32,5 | ○ |
| 84301 1 | 1/2 | 100 | 4,7 | 32,5 x 26,5 | ○ |
| 84302 8 | 2/4 | 100 | 4,3 | 53,0 x 16,2 | ○ |
| 84303 5 | 1/3 | 100 | 2,7 | 32,5 x 17,6 | ○ |
| 84304 2 | 1/4 | 100 | 1,9 | 26,5 x 16,2 | ○ |
| 84305 9 | 1/6 | 100 | 1,0 | 17,6 x 16,2 | ○ |
| 84306 6 | 1/1 | 100 | 10,6 | 53,0 x 32,5 | ● |
| 84307 3 | 1/2 | 100 | 4,7 | 32,5 x 26,5 | ● |
| 84308 0 | 2/4 | 100 | 4,3 | 53,0 x 16,2 | ● |
| 84309 7 | 1/3 | 100 | 2,7 | 32,5 x 17,6 | ● |
| 84310 3 | 1/4 | 100 | 1,9 | 26,5 x 16,2 | ● |
| 84311 0 | 1/6 | 100 | 1,0 | 17,6 x 16,2 | ● |

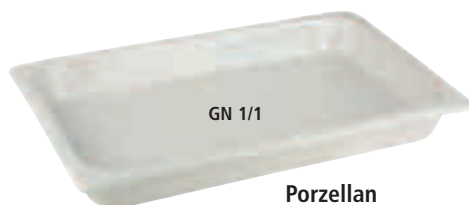

GN 1/1

Porzellan

GN-Behälter
GN-container
cubetas GN
bacs Gastronorme



| | GN | ↑ cm | □ cm |
|---------|-----|------|-------------|
| 82100 2 | 1/1 | 6,5 | 53,0 x 32,5 |
| 82200 9 | 1/2 | 6,5 | 32,5 x 26,5 |
| 82300 6 | 1/3 | 6,5 | 32,5 x 17,6 |

HIGHLINE



GN-Behälter „HIGHLINE“
GN-container
cubetas GN
bacs Gastronomie



extrem bruchsicher, glänzende und harte Oberfläche, tiefkühlfest, keinen Temperaturschocks unterziehen, nicht auf heißen Flächen liegen lassen, elfenbein

durable, top quality, hard and glossy surface, avoid thermal shocks, do not leave on hot surfaces, ivory

duradera, alta calidad, superficie brillante y resistente. Hay que evitar los cambios térmicos bruscos. No apoyar en superficies calientes, blanco

durable, haute qualité, surface brillante et résistante. Eviter les chocs thermiques et ne pas poser sur une surface chaude, blanc ivoire



83762



83763

| | GN | ↓ mm | ltr. | ☐ cm |
|---------|-----|------|------|-------------|
| 83772 0 | 1/1 | 65 | 7,10 | 53,0 x 32,5 |
| 83770 6 | 2/3 | 65 | 4,60 | 35,0 x 32,5 |
| 83768 3 | 1/2 | 65 | 3,40 | 32,5 x 26,5 |
| 83766 9 | 2/4 | 65 | 3,00 | 53,0 x 16,2 |
| 83764 5 | 1/3 | 65 | 2,00 | 32,5 x 17,6 |
| 83762 1 | 1/4 | 65 | 1,35 | 26,5 x 16,2 |
| 83760 7 | 1/6 | 65 | 0,80 | 17,6 x 16,2 |
| 83773 7 | 1/1 | 100 | 11,0 | 53,0 x 32,5 |
| 83769 0 | 1/2 | 100 | 5,50 | 32,5 x 26,5 |
| 83765 2 | 1/3 | 100 | 3,15 | 32,5 x 17,6 |
| 83763 8 | 1/4 | 100 | 2,20 | 26,5 x 16,2 |
| 83761 4 | 1/6 | 100 | 1,25 | 17,6 x 16,2 |



Besteckbehälter
cutlery basket
dispensador de cubiertos
présentoir à couverts



4 Löcher inkl. 4 Edelstahl Köcher
4 holes incl. 4 stainless baskets
4 agujeros incl. dispensa 4 acero cesta
4 places, sans 4 inox corbeille

| | □ cm | ↑ cm | |
|---------|---------|------|---|
| 93321 7 | 27 x 27 | 15 | ● |



11994
mit Köcher /
included dispenser

11996
ohne Köcher /
without dispenser



11997
ohne Köcher

Besteckbehälter
cutlery basket
dispensador de cubiertos
présentoir à couverts



matt poliert
satin polished finish
inox mate (sin cubiertos)
inox mat

| | □ cm | ↑ cm | |
|---------|-------------------|------|--|
| 11994 9 | 26,0 x 30 Ø 10 | 20 | 4 Löcher inkl. Köcher (Kunststoff) 4 holes incl. dispensers (plastic) 4 agujeros incl. Dispensador plástico 4 places, avec 4 récipients (plastique) |
| 11996 3 | 26,0 x 30 Ø 10 | 20 | 4 Löcher ohne Köcher 4 holes without dispensers 4 agujeros sin dispensador de plástico 4 places, sans récipients |
| 11997 0 | 37,5 x 30 Ø 10 | 20 | 6 Löcher ohne Köcher 6 holes without dispensers 6 agujeros sin dispensador de plástico 6 places, sans récipients |



11998
Köcher weiß

11999
Köcher Edelstahl

Besteckköcher
cutlery basket
cesta para cubiertos
corbeille à couverts



| | □ cm | ↑ cm | |
|---------|-------|------|--|
| 11998 7 | Ø 9,7 | 13,7 | Kunststoff weiß white plastic plástico blanco plastique blanc |
| 11999 4 | Ø 9,7 | 13,7 | matt poliert satin polished finish acero inoxidable inox |



GN1/1 - Maß

Besteckbehälter GN 1/1
dispenser GN 1/1
dispensador de cubiertos GN 1/1
bac à couverts GN 1/1



in Handarbeit geflochten, 4 Mulden, Kunststoff-Geflecht, Drahtgestell, braun-schwarz
plastic wickerwork, 4 compartments, with reinforced chromed wire structure, brown-black
4 compartimentos, cesta trensada de plástico con bastidor cromado reforzado, marrón oscuro
4 compartiments, corbeille en plastique tressé, cadre acier chromé renforcé, couleur marron foncé

| | □ cm | ↑ cm | |
|---------|-----------|------|---|
| 11966 6 | 53 x 32,5 | 9 | ● |



GN1/1 - Maß

Besteckbehälter „BUFFET“ GN 1/1
cutlery dispenser GN 1/1
dispensador de cubiertos GN 1/1
bac à couverts GN 1/1



4 Mulden, Kunststoff-Geflecht, Drahtgestell, beige
 4 troughs, wickerwork, wire, beige
 4 huecos, trabajo de cestería

4 compartiments, plastique tressé, cadre acier chromé renforcé, couleur osier naturel

| | cm | cm | |
|---------|-----------|----|---|
| 11965 9 | 53 x 32,5 | 10 | ● |



11955

11957

Besteckbehälter GN 1/1
cutlery tray / box stand GN 1/1
dispensador de cubiertos GN 1/1
bac à couverts GN 1/1



| | cm | cm | |
|---------|-----------|----|---|
| 11955 0 | 53 x 32,5 | 10 | ● |
| 11957 4 | 53 x 32,5 | 10 | ○ |



11962

11960

Besteckkasten GN 1/1
cutlery box GN 1/1
dispensador de cubiertos GN 1/1
bac à couverts GN 1/1



| | cm | cm | |
|---------|-----------|----|---|
| 11960 4 | 53 x 32,5 | 10 | ● |
| 11962 8 | 53 x 32,5 | 10 | ○ |

Tisch Set „VARIO II“
table set
set de mesa
set de table



4-teilig: 1 Ständer + 3 Behälter (innen Ø 9 cm) für Besteck, Servietten etc., vielseitig einsetzbar
 4 pcs. set: 1 stand + 3 bins (inner Ø 9 cm) for cutlery, napkins etc., versatile applicable
 4 piezas: 1 soporte + 3 recipientes Ø 9 cm para cubiertos, servilletas etc
 4 hauteurs: 1 support, 3 récipients int. 9 cm, pour couverts, serviettes,...

| | cm | cm |
|---------|---------|----|
| 11927 7 | 22 x 22 | 26 |

designed by **CULTURE FORM**

NEW



**Besteckständer
cutlery basket
cesta para cubiertos
égouttoir à couverts**



matt poliert / satin polished finish / inox mate (sin cubiertos) / inox mat

| | ☐ cm | ↑ cm |
|---------|--------|------|
| 11923 9 | Ø 12,5 | 15,5 |



**Besteckständer
cutlery basket
cesta para cubiertos
égouttoir à couverts**



matt poliert / satin polished finish / inox mate (sin cubiertos) / inox mat

| | ☐ cm | ↑ cm |
|---------|------|------|
| 11921 5 | Ø 10 | 10,0 |
| 11922 2 | Ø 12 | 13,5 |



**Besteck-Korb
cutlery dispenser
dispensador de cubiertos
corbeille à couverts**



in Handarbeit geflochten
wickerwork
trensado a mano
tressage main

| | ☐ cm | ↑ cm | |
|---------|---------|------|---|
| 40130 3 | Ø 12 | 15,0 | ● |
| 40131 0 | 27 x 10 | 4,5 | ● |
| 40007 8 | Ø 12 | 15,0 | ● |
| 40009 2 | 27 x 10 | 4,5 | ● |



**Gläsertransportkiste
glass carry box
caja para transporte de vasos
caisse à verres**



für 50 x 0,2 Liter Gläser, Abstellfach 6,8 x 6,8 cm
for 50 glasses of 20 cl - Compartments 6,8x6,8 cm
para 50 vasos de 20 cl - Compartimentos de 6,8x6,8 cm
pour 50 verres de 20 cl - Compartiments de 6,8x6,8 cm

| | ☐ cm | |
|---------|----------------|---|
| 00888 5 | 74 x 38,5 x 19 | ● |

für 32 x 0,3 / 0,4 Liter Gläser, Abstellfach 8,5 x 8,5 cm
for 32 glasses of 30 cl - Compartments 8,5x8,5 cm
para 32 vasos de 30 cl - Compartimentos de 8,5x8,5 cm
pour 32 verres de 30 cl - Compartiments de 8,5x8,5 cm

| | | |
|---------|----------------|---|
| 00889 2 | 74 x 38,5 x 24 | ● |
|---------|----------------|---|

Eier-Box
Eggs-box
caja para huevos
boîte à oeufs



mit luftdichtem Deckel, passend für 4 Lagen á 30 Eier, Lieferung inkl. 8 Lagen, Größe Lage: 28 x 28 cm

with airtight cover, capacity container: 4 trays of 30 eggs, delivery with 8 trays, size of tray: 28 x 28 cm

capacidad para 4 bandejas de 30 huevos, tapa hermética. Se entrega con 8 bandejas formato bandejas 28x28 cm. Apto para lavavajillas

pour 4 plateaux de 30 oeufs chacun, apte pour 4 plateaux plats, couvercle hermétique. Livré avec 8 plateaux. Dim° plateau 28x28 cm. Lavable en lave-vaisselle

| | ☐ cm | ↓ cm |
|---------|-------------|------|
| 82419 5 | 35,4 x 32,5 | 20 |

Einzelteile / spare parts / piezas sueltas / pièces détachées

10 Lagen / 10 trays / 10 bandejas / 10 plateaux

| |
|---------|
| 82420 1 |
|---------|

3 Größen



Rechteckschalen
container
cubeta
bac



| | ☐ cm | ↑ cm | ltr. |
|---------|-----------|------|------|
| 11941 3 | 30 x 21,0 | 6,5 | 2 |
| 11942 0 | 34 x 23,5 | 7,0 | 3 |
| 11943 7 | 48 x 33,0 | 8,0 | 8 |

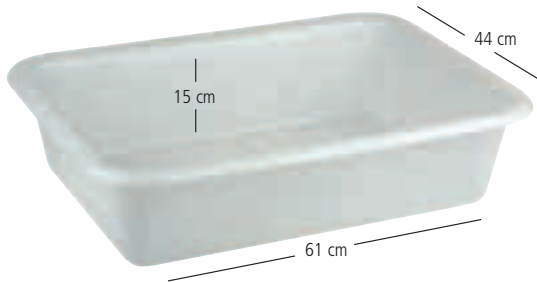

Wanne
container
cubeta
bac



stabile Ausführung
 robust
 robusta
 robuste

| | ☐ cm | ↑ cm | ltr. |
|---------|---------|------|------|
| 11940 6 | 61 x 44 | 15 | 25 |



Geschirrwanne
container
cubeta para vajilla
bac à vaisselle



| | ☐ cm | ↑ cm |
|---------|---------|------|
| 11950 5 | 55 x 42 | 14 |

THERMO-BOX



Thermo-Box - Komplett-Lösung für Gastronomie, Catering und Partyservice

mit Extra-Beschriftungsfeld

System-Thermo-Box GN1/1



beste Isoliereigenschaften, hygienisch, empfohlen nach HACCP, einsetzbar von -40° bis +120°C, mit Beschriftungsfeld, jede Box ist als Deckel- und Bodenteil verwendbar

best isolation quality, hygienic, HACCP standards, usable from -40°C to +120°C. Stackable, each box can be used as a lid for the lower box

apilable, aislante, irrompible, higiénico, HACCP stantard de -40° hasta + 120°C. Al apilar, lpuede usar otra caja arriba como tapa, y así sucesivamente.

excellente isolation, hygiénique, recommandé HACCP, utilisable entre -40°c etT +120°C. Empilables une boîte sur l'autre, la boîte supérieur sert alors de couvercle

| | ☐ cm | ↑ cm | |
|---------|-----------|------|------------------------------|
| 11312 1 | 59,5 x 39 | 12,0 | Nutzhöhe 8 cm (ohne Deckel) |
| 11315 2 | 59,5 x 39 | 16,5 | Nutzhöhe 12 cm (ohne Deckel) |
| 11319 0 | 59,5 x 39 | | Zusatzdeckel, flach |

Thermo-Box mit Doppelfunktion
jede Box ist als Deckel- und Bodenteil
verwendbar

Einzelteile / spare parts / piezas sueltas / pièces détachées

passende Systemtablets
matching system- trays
bandeja systemtablets
bandeja systemtablets

| | | |
|---------|-------------|-----|
| 11300 8 | 53 x 32,5 | 1/1 |
| 11290 2 | 53 x 32,5 | 1/1 |
| 83980 9 | 53,0 x 32,5 | 1/1 |



passende Tablett
11300



passende Tablett
11290



passende Tablett
83980

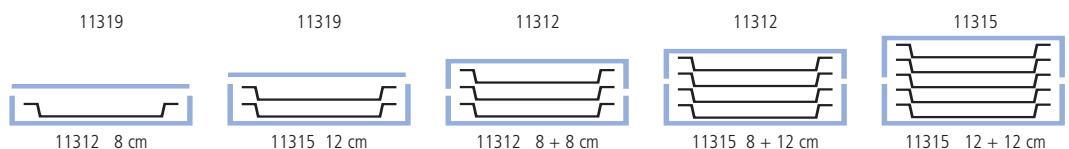

So ergeben sich je nach Bedarf
5 verschiedene Nutzhöhen
und Bestückungsmöglichkeiten.

Thermo-Box „UNIVERSAL“



beste Isoliereigenschaften, hygienisch, empfohlen nach HACCP, einsetzbar von -40°C bis +120°C, mit Beschriftungsfeld, jede Box ist als Deckel- und Bodenteil verwendbar
best isolation quality, hygienic, HACCP standards, usable from -40°C to +120°C. Stackable, each box can be used as a lid for the lower box

| | cm | cm | ltr. |
|---------|-------------|----|------|
| 49258 5 | 68,5 x 48,5 | 36 | 80 |

Thermo-Box „HOT COOL“



beste Isoliereigenschaften, hygienisch, empfohlen nach HACCP, einsetzbar von -40°C bis +120°C, mit Beschriftungsfeld, jede Box ist als Deckel- und Bodenteil verwendbar
best isolation quality, hygienic, HACCP standards, usable from -40°C to +120°C. Stackable, each box can be used as a lid for the lower box

| | cm | cm | ltr. |
|---------|-------------|----|------|
| 49310 0 | 38,0 x 30,0 | 13 | 7,5 |

Thermo-Box „PIZZA“



beste Isoliereigenschaften, hygienisch, empfohlen nach HACCP, einsetzbar von -40°C bis +120°C, mit Beschriftungsfeld, jede Box ist als Deckel- und Bodenteil verwendbar
best isolation quality, hygienic, HACCP standards, usable from -40°C to +120°C. Stackable, each box can be used as a lid for the lower box

| | cm | cm | ltr. |
|---------|-------------|------|------|
| 49738 2 | 41,0 x 41,0 | 37,5 | 37,5 |

Thermo-Box „GN 1/1“



beste Isoliereigenschaften, hygienisch, empfohlen nach HACCP, einsetzbar von -40°C bis +120°C, mit Beschriftungsfeld, jede Box ist als Deckel- und Bodenteil verwendbar
best isolation quality, hygienic, HACCP standards, usable from -40°C to +120°C. Stackable, each box can be used as a lid for the lower box

| | cm | cm | ltr. |
|---------|-----------|----|------|
| 49638 5 | 59,5 x 39 | 28 | 38 |

HOT PRICE

Servier- / Transportwagen
service trolley
carro de servicio
chariot de service



Lieferung demontiert

mit 2 Borden, Bordmaße ca. 83 x 51 cm, Abstand zwischen den Borden ca. 56 cm, Tragfähigkeit 80 kg, 4 Lenkrollen, davon 2 feststellbar, Lieferung demontiert, einfache Montage
 with 2 trays, trays approx. 83 x 51 cm, size between the trays approx. 56 cm, total load capacity 80 kg, 4 wheels with 2 brakes, unassembled, simple assembly

con 2 bandejas de acero inoxidable mate, aprox. 83 x 51 cm, la medida entre bandejas aprox. 56 cm, capacidad total 80 kg, 4 ruedas, con 2 frenos, construcción robusta, fácil montaje.

3 niveaux, approx. 83x51 cm chacun, distance entre niveaux 56 cm, capacité maxi 80 kg au total, 4 roues dont 2 avec frein. Construction robuste, montage facile

| | ☐ cm | ↑ cm |
|---------|---------|------|
| 11977 2 | 91 x 59 | 93 |

HOT PRICE

Servier- / Transportwagen
service trolley
carro de servicio
chariot de service



Lieferung demontiert

mit 3 Borden, Bordmaße ca. 83 x 51 cm, Abstand zwischen den Borden ca. 26 cm, Tragfähigkeit 120 kg, 4 Lenkrollen, davon 2 feststellbar, Lieferung demontiert, einfache Montage

with 3 trays, trays approx. 83 x 51 cm, size between the trays approx. 26 cm, total load capacity 120 kg, 4 wheels with 2 brakes, unassembled, simple assembly

con 3 bandejas inox mate, aprox. 83 x 51 cm, la medida entre bandejas aprox. 26 cm capacidad total 120 kg, 4 ruedas con 2 frenos, construcción robusta, fácil montaje.

3 niveaux, approx. 83x51 cm chacun, distance entre niveaux 26 cm, capacité maxi 120 kg au total, 4 roues dont 2 avec frein. Construction robuste, montage facile

| | ☐ cm | ↑ cm |
|---------|---------|------|
| 11979 6 | 91 x 59 | 93 |

PROFI-QUALITY

Servierwagen- / Transportwagen
serving trolley
carro de servicio
chariot de service



Lieferung demontiert

Gestell aus Vierkantrrohr 25 x 25 mm, Ablagefläche innen 84 x 44,5 cm, Bodenfläche 90 x 50 cm, auf Unterseite schalldämmend beschichtet, Abstand zwischen den Böden 28 cm/29 cm, mit 4 Lenkrollen Ø 12,5 cm, alle mit Feststellern, Lieferung demontiert, einfache Montage, Tragfähigkeit 33 kg je Boden

frame rectangular bar 25 x 25 mm, shelf board inside 84 x 44,5 cm, shelf board outside 90 x 50 cm, undersurface coated sound-damping, distance between the boards 28 cm/29 cm, with 4 swivel wheels Ø 12,5 cm, all with brakes, unassembled, simple assembly, max load 33 kg per shelf

estructura tubo cuadrado 25 x 25 mm. Útiles int. Por piso 84 x 44,5 cm. ext. al suelo 90 x 50 cm revestimiento para absorber ruidos distancia entre pisos 28 cm/29 cm, 4 ruedas giratorias 12,50 cm, con frenos, se sirve desmontado, fácil montaje, carga máx. 33 kg, por piso

structure en tube carré 25x25 mm, 3 niveaux dimensions utiles 84x44,5 cm, encombrement au sol 90x50 cm, avec revêtement en partie inférieure pour absorber le bruit. Distance entre niveaux 28 cm/29 cm, roues pivotantes 12,5 cm, avec frein. Livré démonté, montage aisé. Maxi 33 kg de charge par niveau.

| | ☐ cm | ↑ cm |
|---------|---------|------|
| 71440 3 | 96 x 50 | 94 |

Rollen
 Ø 12,5 cm



Lieferung demontiert

Regalwagen GN1/1
trolley GN1/1
carro GN 1/1
chariot GN 1/1



mit 15 Doppelauflegeschieben, zum Transport von bis zu 30 GN-Tablets GN1/2 oder 15 GN-Behältern bis GN1/1 (Längseinschub), bei einem Stapelabstand von 75 mm, mit 4 Lenkrollen, 2 mit Feststellern, Tragfähigkeit 100 kg

15 double bars, for transporting up to 30 trays GN1/2 or 15 GN-containers up to GN1/1, size between the trays 75 mm, 4 swivel wheels, 2 equipped with brakes total load capacity 100 kg

15 pares de rieles dobles para el transporte de hasta 30 bandejas o 15 cubetas GN 1/1 (apertura por el lado estrecho) distancia entre las bandejas de 75 mm, 2 ruedas giratorias con frenos, carga máxima 100 kg

15 rails doubles pour maxi 30 plateaux GN 1/2 ou 15 plateaux GN 1/1 (ouverture sur le côté étroit 32,5cm). Espace entre plateaux 75 mm. 2 roues pivotantes avec frein, charge maxi 100 kg

| | ☐ cm | ↑ cm |
|---------|-----------|-------|
| 71441 0 | 55 x 38,5 | 173,5 |



mit beidseitiger Kipp- und Durchschubsicherung

HOT PRICE



4 Lenkrollen
 inklusive Feststellern
 Lieferung demontiert

Servier- / Transportwagen
servicing trolley
carro de servicio
chariot de service



Aluminiumrahmen, 3 Böden, Abstand zwischen den Böden 31 cm, mit 4 Lenkrollen, alle mit Feststellern, Tragfähigkeit: ca. 150 kg je Boden, 450 kg insgesamt, demontiert, einfache Montage, Lieferung ohne Container und Dekoration

frame aluminium, 3 shelves, distance between shelves 31 cm, 4 swivel wheels, all equipped with brakes, max. load per shelf 150 kg, 450 kg total, demounted, easy to mount, delivery without containers and decoration

marco aluminio, 3 pisos, distancia entre cada piso 31 cm, 4 ruedas giratorias las 4 con frenos, carga máxima por bandeja 150 kg, 450 kg en total, se sirve desmontado, fácil de montar (se sirve sin contenedores ni decoración)

chassis aluminium, 3 étages, distance entre niveaux 31 cm, 4 roues pivotantes, toutes avec frein, charge maximum 150 kg par niveau, 450 kg au total, livré démonté, montage facile (livré sans récipients ni décoration)

| | ☐ cm | ↑ cm |
|---------|----------|------|
| 11945 1 | 108 x 50 | 96 |



11947



11946

Container
container
contenedor
réceptient



zum Einhängen, passend zum Servier- / Transportwagen 11945

to hang up, suitable serving trolley 11945

para colgar, adaptado para el carro ref. 11945

| | ☐ cm | ↑ cm | ltr. |
|---------|---------|------|------|
| 11947 5 | 33 x 23 | 17,5 | 13 |
| 11946 8 | 33 x 23 | 56,5 | 42 |

STOP-TOOLS designed by formel²³ PRODUKTDESIGN

Die **STOP**-Funktion verhindert, dass Gabel oder Löffel in das Gefäß rutschen.

The smart **STOP**-function prevent forks and spoon not to slip into the vessel.

La función **STOP** evita que los cubiertos se caigan dentro del recipiente. Antideslizante.

La fonction **STOP** empêche les couverts de glisser dans le récipient.

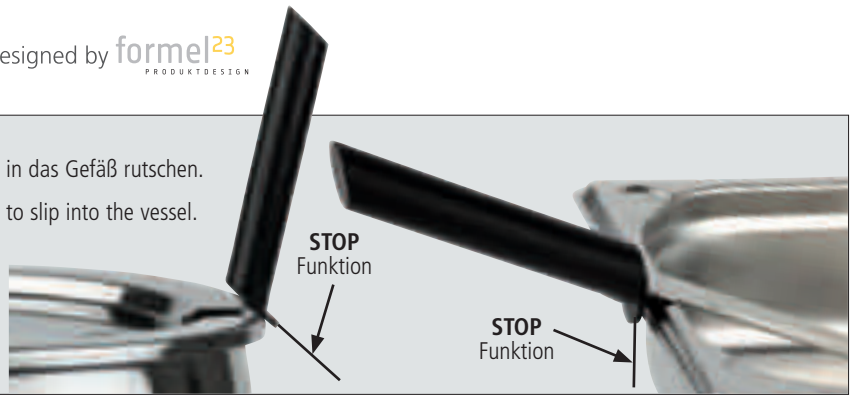

Fleischgabel
meat fork
tenedor de carne
fourchette à viande



Materialdicke 2,5 mm, ergonomischer rutschfester Griff
ergonomic antislip handle
mando ergonómico antideslizante
manche ergonomique anti-dérapant

| | cm | → cm |
|---------|------|------|
| 00831 1 | 10,5 | 38,5 |



Schöpflöffel
ladle
cucharón
louche



Materialdicke 2,5 mm, ergonomischer rutschfester Griff
ergonomic antislip handle
mando ergonómico antideslizante
manche ergonomique anti-dérapant

| | cm | → cm |
|---------|-----|------|
| 00832 8 | Ø 9 | 35 |



Servierlöffel geschlitzt
slotted spoon
cuchara de servicio
cuillère de service



Materialdicke 2,5 mm, ergonomischer rutschfester Griff
ergonomic antislip handle
mando ergonómico antideslizante
manche ergonomique anti-dérapant

| | cm | → cm |
|---------|----------|------|
| 00833 5 | 10 x 7,5 | 37,5 |



Servierlöffel
spoon
cuchara de servicio
cuillère de service



Materialdicke 2,5 mm, ergonomischer rutschfester Griff
ergonomic antislip handle
mando ergonómico antideslizante
manche ergonomique anti-dérapant

| | cm | → cm |
|---------|----------|------|
| 00834 2 | 10 x 7,5 | 37,5 |



Schöpflöffel „PROFI“
ladle
cacillo
louche



| | □ cm | → cm | ltr. |
|---------|--------|------|-------|
| 00710 9 | Ø 5 | 32,0 | 0,030 |
| 00711 6 | Ø 6 | 34,0 | 0,050 |
| 00712 3 | Ø 7 | 35,5 | 0,080 |
| 00713 0 | Ø 8 | 38,0 | 0,125 |
| 00714 7 | Ø 9 | 42,0 | 0,150 |
| 00715 4 | Ø 10 | 43,5 | 0,250 |
| 00716 1 | Ø 11 | 45,0 | 0,300 |
| 00717 8 | Ø 14,5 | 48,0 | 0,550 |



Schaumlöffel „PROFI“
skimmer
espumadera
écumoire



| | □ cm | → cm |
|---------|------|------|
| 00720 8 | Ø 8 | 37,0 |
| 00721 5 | Ø 10 | 40,5 |
| 00722 2 | Ø 12 | 46,0 |
| 00723 9 | Ø 14 | 50,5 |



Wender „PROFI“
turner
espátula
spatule



| | □ cm | → cm |
|---------|-----------|------|
| 00730 7 | 10 x 11,5 | 52 |



Servierlöffel „PROFI“
spoon
cuchara
cuillère de service



| | □ cm | → cm |
|---------|----------|------|
| 00672 0 | 10,5 x 7 | 41 |



Servierlöffel geschlitzt „PROFI“
slotted spoon
cuchara de servicio agujereada
cuillère de service ajourée



| | □ cm | → cm |
|---------|----------|------|
| 00671 3 | 10,5 x 7 | 41 |



Spaghettilöffel „PROFI“
spaghetti spoon
cuchara de spaghetti
cuillère à spaghettis



| | □ cm | → cm |
|---------|----------|------|
| 00673 7 | 11 x 6,5 | 39 |



Fleischgabel
meat fork
tenedor de carne
fourchette à viande



| | cm | → cm |
|---------|--------|------|
| 00666 9 | 7 / 10 | 34 |

rutschsichere Griffe, schwarzer Griff,
 hitzebeständig bis 120°C

antislip, black handle,
 heat-resistant up to 120°C

antideslizante, mango negro,
 resiste hasta + 120°C

anti-glisse, manche noir,
 résistant à +120°C



Schöpflöffel
ladle
cucharón
louche



| | cm | → cm | ltr. |
|---------|-------|------|------|
| 00670 6 | 9 x 9 | 34 | 0,15 |



Servierlöffel
spoon
cuchara
cuillère



| | cm | → cm |
|---------|----------|------|
| 00662 1 | 10,5 x 7 | 34 |



Servierlöffel gelocht
slotted spoon
cuchara de servicio
cuillère de service



| | cm | → cm |
|---------|----------|------|
| 00664 5 | 10,5 x 7 | 34 |



Bratenwender
slotted turner
espátula para plancha
spatule pour le grill



| | cm | → cm |
|---------|--------|------|
| 00668 3 | 10 x 8 | 36 |

NEW

Wein-/Sektkübler
wine / champagne bowl
cupitera para vino y cava
seau à vin ou Champagne



mit seitlichen Griffen, transparent
 with lateral handles, transparent
 con asas laterales
 avec poignées latérales

| | □ cm | ↑ cm | litr. | |
|---------|-----------|------|-------|---------|
| 36087 7 | 32 x 21,5 | 24,5 | 7 | ○ clear |
| 36088 4 | 32 x 21,5 | 24,5 | 7 | ● green |
| 36089 1 | 32 x 21,5 | 24,5 | 7 | ● pink |



glasklar / clear
36087



grün / green
36088



pink
36089

Wein- / Sektkübler
wine / champagne bowl
cupitera para vino y cava
rafraichisseur à vin ou champagne



| | □ cm | ↑ cm | litr. | |
|---------|------|------|-------|---------|
| 36078 5 | Ø 20 | 25 | 3,5 | ○ clear |
| 36079 2 | Ø 20 | 25 | 3,5 | ● black |
| 36080 8 | Ø 20 | 25 | 3,5 | ○ white |



glasklar / clear
36078



schwarz / black
36079



weiß / white
36080



Wein- / Sektkühler
wine / champagne bowl
cubitera para vino y cava
seau à vin ou Champagne



mit seitlichen Griffen, transparent
 with lateral handles, transparent
 con asas laterales
 avec poignées latérales

| | □ cm | ↑ cm | ltr. |
|---------|---------|------|------|
| 36081 5 | 20 x 20 | 20 | 4,5 |



Flaschenkühler / Getränkeschale
bottle cooler
enfriador de botella
rafraîchisseur



mit seitlichen Griffen, transparent
 with lateral handles, transparent
 con asas laterales
 avec poignées latérales

| | □ cm | ↑ cm | ltr. |
|---------|-------------|------|------|
| 36082 2 | 35,5 x 35,5 | 20 | 16 |



Wein- / Sektkühler
wine cooler
enfriador para vino
rafraîchisseur à vin



innen mattiert, außen hochglanz, mit massiven Knopf-Griffen, extra stabiler eingerollter Rand, schwere Ausführung
 outside mirror polished finish, inside satin polished finish, with solid knob handles, rolled edge, heavy quality
 acabado pulido brillante, asas de botón robustas, borde redondeado alta calidad
 brillant, 2 poignées robuste en forme de bouton, bord arrondi. Haute qualité

| | □ cm | ↑ cm | ltr. |
|---------|-------------|------|------|
| 36028 0 | Ø 21,5 / 16 | 22 | 4 |



Wein- / Sektkühler „HAMMERSCHLAG“
wine cooler
enfriador para vino
rafraîchisseur à vin



hochglanzpoliert, mit massiven Ring-Griffen, eingerollter Rand
 mirror polished finish, with solid ring handles, rolled edge, hammered
 acabado pulido brillante, con 2 anillos macizas, borde redondeado, repujado
 brillant, 2 anneaux massifs, bord arrondi, surface martelée

| | □ cm | ↑ cm | ltr. |
|---------|-----------|------|------|
| 36026 6 | Ø 21 / 17 | 21,5 | 4 |



Wein- / Sektkühler
wine cooler
enfriador para vino
rafraîchisseur à vin



matt poliert, Hohlgriffe
 satin polished finish, hollow handles
 acabado pulido satinado, con asas huecas
 finition mate, 2 boutons creux

| | □ cm | ↑ cm | ltr. |
|---------|-----------|------|------|
| 36021 1 | Ø 20 / 15 | 20,5 | 4 |



Wein- / Sektkühler
wine cooler
enfriador para vino
rafraîchisseur à vin



innen mattiert, außen poliert, mit massiven Griffen, Rand eingerollt
 outside mirror polished finish, inside satin polished finish, with massive handles, rolled edge
 pulido mate, 2 asas macizas, borde redondeado
 finition mate, 2 anses massives, bord rond

| | □ cm | ↑ cm | ltr. |
|---------|-----------|------|------|
| 36025 9 | Ø 21 / 15 | 21 | 3,5 |

HOT PRICE



Wein- / Sektkühler
wine cooler
enfriador para vino
rafraîchisseur à vin



aussen hochglanzpoliert, innen matt poliert, mit Ring-Griffen
 outside mirror polished finish, inside satin polished finish, with ring handles
 exterior pulido brillante, interior efecto satinado con 2 asas anillos
 extérieur brillant, intérieur satin, avec 2 anneaux

| | □ cm | ↑ cm | ltr. |
|---------|-----------|------|------|
| 36020 4 | Ø 20 / 15 | 19 | 3 |

HOT PRICE



Wein- / Sektkühler
wine / champagne cooler
enfriador para vino y cava
rafraîchisseur à vin ou champagne



glasklarer Rand, transparent gefrostet
 edge transparent, body transparent frosted
 borde transparente, cuerpo transparente efecto glaseado
 bord transparent, corps finition mate

| | □ cm | ↑ cm | ltr. |
|---------|-----------|------|------|
| 36066 2 | Ø 22 / 14 | 23 | 4 |

designed by **CULTURE FORM**

**Weinkühler-Ständer
stand for wine cooler
pie porta champanera
pied pour seau à champagne**



innen Ø 17,5 cm



Höhe
73 cm

Ø 26,5 cm

36069

hochglanzpoliert, schwerer standsicherer Fuß, Innendurchmesser der Schale Ø 17,5 cm
mirror polished finish, heavy foot, inner bowl Ø 17,5 cm
acabado pulido efecto brillante, utilizable para todos los enfriadores de vinos APS, bol interior de Ø 17,5 cm.
brillant, apte pour tous les seaux à vin ou Champagne de APS, intérieur support Ø 17,5 cm

| | ☐ cm | ↑ cm |
|---------|---------------|------|
| 36069 3 | Ø 17,5 / 26,5 | 73 |



36028



Ø 15 cm

Höhe
68 cm

Ø 28 cm

36068

**Weinkühler-Ständer
stand for wine cooler
pie porta champañera
pied pour seau à champagne**



hochglanzpoliert, schwerer standsicherer Fuß, Innendurchmesser der Schale Ø 15 cm
mirror polished finish, heavy foot, inner bowl Ø 15 cm
acabado pulido efecto brillante, utilizable para todos los enfriadores de vinos APS, bol interior de Ø 15 cm.
brillant, apte pour tous les seaux à vin ou Champagne de APS, intérieur support Ø 15 cm

| | ☐ cm | ↑ cm |
|---------|-----------|------|
| 36068 6 | Ø 15 / 28 | 68 |

**Tischhalterung für Sektkühler
Champagne Bucket Table holder
Soporte champañera universal
Porte-seau à champagne**

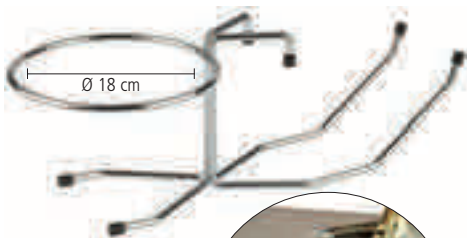

Ø 18 cm

aus 8 mm starkem Stahldraht, passend zu allen lieferbaren Sektkühlern, innen Ø-Ring: 18 cm
8 mm chrome plated wire, suitable for all available champagne buckets
Alambre cromado 8 mm, para todas las champañeras
Fil chromé 8 mm, pour tous les seaux à champagne



| | ☐ cm | ↑ cm |
|---------|---------|------|
| 30332 4 | 49 x 20 | 17 |

NEW



Champagnerkühler „CHAMPION“
champagne bowl
champañera
seau à Champagne



doppelwandig für beste Isolierung, hochglanzpoliert
double wall cooler keeps the temperature for a long time, mirror polished
Champañera inox de doble pared. Interior mate, exterior brillante
Seau inox double paroi, maintient le froid plus longtemps. Intérieur mat, extérieur poli brillant

| | cm | cm | ltr. |
|---------|------|----|------|
| 36076 1 | Ø 44 | 32 | 15 |



doppelwandig
double wall

designed by **CULTURE FORM**

Flaschenkühler „BRIDGE“
bottle cooler
champañera de buffet
seau à champagne



doppelwandig für beste Isolierung, außen poliert, innen mattiert
Double wall cooler keeps the temperature for a long time, outside mirror polished, inside matt finish
Champañera inox de doble pared. Interior mate, exterior brillante
Seau inox double paroi, maintient le froid plus longtemps. Intérieur mat, extérieur poli brillant



10 ltr.

| | cm | cm | ltr. |
|---------|------|----|------|
| 36077 8 | Ø 19 | 19 | 10 |



13985



**Champagnerkühler
champagne bowl
cubo champañera
seu à Champagne**



außen hochglanzpoliert, innen matt poliert, mit vergoldeten Griffen
outside mirror polished finish, inside satin polished finish, with gold plated handles
exterior pulido brillante, interior satinado
extérieur brillant, intérieur satin

| | □ cm | ↑ cm | litr. |
|---------|-----------|------|-------|
| 36047 1 | Ø 42 / 27 | 28 | 20 |



36071

**Wein- / Sektkühler
wine / champagne bowl
champañera
seu à Champagne**



| | □ cm | ↑ cm | litr. | |
|---------|-------------|------|-------|----------------|
| 36071 6 | 30,5 x 22,5 | 23,5 | 5 | ● klar / clear |
| 36072 3 | 30,5 x 22,5 | 23,5 | 5 | ● |
| 36073 0 | 30,5 x 22,5 | 23,5 | 5 | ● |



36072



36073



36048

**Wein- / Sektkühler
wine / champagne bowl
champañera
seu à vin ou Champagne**



mit 2 seitlichen Eingriffen
with 2 handles on the side
con 2 asas en los lados
avec 2 poignées

| | □ cm | ↑ cm | litr. | |
|---------|---------|------|-------|----------------|
| 36048 8 | 35 x 27 | 25,5 | 6 | ○ klar / clear |
| 36052 5 | 27 x 20 | 21 | 3 | ○ klar / clear |
| 36054 9 | 35 x 27 | 25,5 | 6 | ● |
| 36053 2 | 27 x 20 | 21 | 3 | ● |



36053



**Champagnerkühler
champagne bowl
cubo champañera
seau à Champagne**



hochglanzpoliert, Lieferung ohne Gläser-Ring
mirror polished finish, delivery without holder
acabado efecto brillante, se entrega sin el aro colgador para copas
brillant, livré sans le support à flûtes

| | cm | cm | litr. |
|---------|---------------|------|-------|
| 36045 7 | Ø 40,5 / 27,5 | 22,5 | 13,5 |

**Gläser-Ring
ring / holder
aro colgador para copas
cercle support à flûtes**



12 Gläser einhängbar
usable for 12 glasses
para 12 copas
pour 10 verres

| | | | |
|---------|--------|---|--|
| 36065 5 | Ø 48,5 | 4 | |
|---------|--------|---|--|



**Champagnerkühler
champagne bowl
cubo champañera
seau à Champagne**

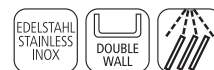

hochglanzpoliert, doppelwandig
mirror polished finish, double wall
acabado pulido brillante con doble pared
brillant, double paroi

| | cm | cm | litr. |
|---------|-----------|----|-------|
| 36044 0 | Ø 44 / 25 | 24 | 10,5 |



doppelwandig für beste
Isolationseigenschaften



**Champagnerkühler
champagne bowl
cubo champañera
seau à Champagne**



hochglanzpoliert, Rand matt poliert
mirror polished finish, edge satin polished finish
acabado pulido brillante, borde satinado
brillant, bord mat

| | cm | cm | litr. |
|---------|-----------|----|-------|
| 36046 4 | Ø 45 / 21 | 23 | 12 |



Wein- / Sektkühler
wine / champagne bowl
champañera
seau à vin ou Champagne



glasklar, für bis zu 6 Flaschen geeignet
 transparent, suitable for up to 6 bottles
 transparente para máximo de 6 botellas
 transparent, maxi 6 bouteilles

| | ☐ cm | ↑ cm | ltr. |
|---------|---------|------|------|
| 36057 0 | 47 x 28 | 23 | 10 |



Champagnerkühler
champagne bowl
champañera
seau à Champagne



glasklar
 transparent
 transparente
 transparent

| | ☐ cm | ↑ cm | ltr. |
|---------|-----------|------|------|
| 36049 5 | Ø 44 / 26 | 25 | 15 |



Wein- / Sektkühler
wine / champagne bowl
cupitera para vino y cava
seau à vin ou Champagne



glasklar, mit Tragegriff
 transparent, handle on the side
 transparente, con un asa en el lateral.
 transparent, avec poignée

| | ☐ cm | ↑ cm | ltr. |
|---------|---------|------|------|
| 36055 6 | 23 x 22 | 27,5 | 3 |



Wein- / Sektkühler
wine / champagne bowl
champañera para vino y cava
seau à vin ou Champagne



glasklar, für zwei Flaschen
 transparent, for two bottles
 transparente, para 2 botellas
 transparent, pour 2 bouteilles

| | ☐ cm | ↑ cm | ltr. |
|---------|-------------|------|------|
| 36056 3 | 30,5 x 21,5 | 26 | 4 |

Konferenzkühler „SIEGER DESIGN“
conference bottle cooler
enfriador múltiple
rafraichisseur CONFÉRENCE



00620

inkl. Kühlakku, Kapselheber, Kronkorkenschale, mit 6 Öffnungen Ø 6,7 cm für 0,25 - 0,5 Liter-Flaschen

incl. bottle cooler, bottle opener, small cap bowl, with 6 holes Ø 6,7 cm for 0,25 to 0,5 liter bottles

con acumulador de frío, abridor, recuperador de chapas, 6 plazas Ø 6,7 cm, para botellas de 25 a 50 cl

avec accumulateur de froid, décapsuleur, bol récupérateur de capsules, 6 places Ø 6,7 cm, pour bouteilles de 25 à 50 cl

| | ☐ cm | ↑ cm | |
|---------|------|------|---|
| 00620 1 | Ø 23 | 14 | ○ |
| 00621 8 | Ø 23 | 14 | ● |

Einzelteile / spare parts / piezas sueltas / pièces détachées

Kühlakku / cooler / acumulador de frío / accumulateur de froid

| | | | |
|---------|-------|------|---|
| 00616 4 | Ø 7,5 | 11,5 | ○ |
| 00615 7 | Ø 7,5 | 11,5 | ● |

Kapselheber / bottle opener / abridor / décapsuleur

| | | | |
|---------|-----|------|--|
| 00617 1 | Ø 1 | 13,5 | |
|---------|-----|------|--|

Kronkorkenschale / cap bowl / cuenco para chapas / bol récupérateur de capsules

| | | | |
|---------|-------|---|---|
| 00618 8 | Ø 6,5 | 3 | ○ |
| 00619 5 | Ø 6,5 | 3 | ● |



00621



stapelbar



inkl. Kronkorkenschale



00616
Kühlakku

designed by **sieger design**



Flaschenkühler „Crystal“
cooler
enfriador de vino
rafraîchisseur à vin



doppelwandig für beste Isolierung, glasklar
doublewall, clear
doble pared
double paroi

| | □ cm | ↑ cm |
|---------|---------------|------|
| 36062 4 | Ø 13,5 / 10,5 | 23 |

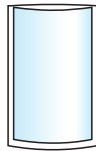

doppelwandig
double wall

designed by **sieger design**



Flaschenkühler „PURE“
cooler
enfriador de vino
rafraîchisseur à vin



doppelwandig für beste Isolierung, glasklar
doublewall, clear
doble pared
double paroi

| | □ cm | ↑ cm |
|---------|---------------|------|
| 36063 1 | Ø 13,5 / 10,5 | 23 |

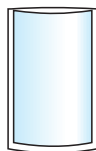

doppelwandig
double wall



individuelle Beschriftung
des Innenbehälters!

individual logo print!





Flaschenkühler „CUPPER“
bottle cooler
enfriador
rafraîchisseur



Hammerschlagoptik, doppelwandig für beste Isolierung
 double wall cooler keeps the temperature for a long time, hammered look
 doble pared para mantener el frigo large tiempo
 double paroi pour une meilleure conservation de la température

| | ☐ cm | ↑ cm | |
|---------|------|------|----------|
| 36074 7 | Ø 12 | 20 | ● copper |

Edelstahl,
 außen verkupfert
 und anlaufgeschützt

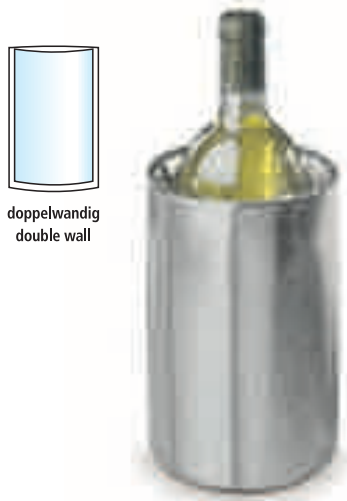

doppelwandig
 double wall

Flaschenkühler
bottle cooler
enfriador
rafraîchisseur



matt poliert, doppelwandig für beste Isolierung, für 0,7 - 1,5 Liter-Flaschen
 satin polished finish, double wall cooler keeps the temperature for a long time, for 0,7 - 1,5 ltr. bottles
 acero inoxidable mate con doble pared para mantener el frio largo tiempo, botellas de 0,7 - 1,5
 inox mat, double paroi pour une meilleure conservation de la température, pour bouteilles de 0,7 a 1,5 L.

| | ☐ cm | ↑ cm |
|---------|-----------|------|
| 36030 3 | Ø 12 / 10 | 20 |

designed by **CULTURE FORM**



Flaschenkühler „LINES“
bottle cooler
enfriador
rafraîchisseur



matt poliert, doppelwandig für beste Isolierung, für 0,7 - 1,5 Liter-Flaschen
 satin polished finish, double wall cooler keeps the temperature for a long time, for 0,7 - 1,5 ltr. bottles
 acero inoxidable mate con doble pared para mantener el frio largo tiempo, botellas de 0,7 - 1,5
 inox mat, double paroi pour une meilleure conservation de la température, pour bouteilles de 0,7 a 1,5 L.

| | ☐ cm | ↑ cm |
|---------|------|------|
| 36002 0 | Ø 12 | 20 |

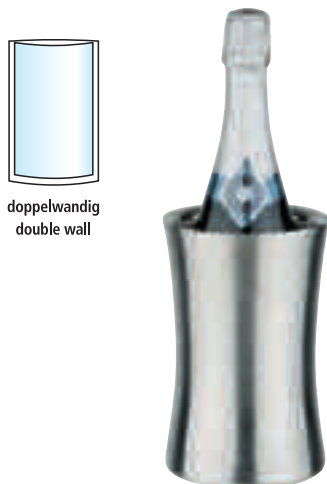

doppelwandig
 double wall

Flaschenkühler
bottle cooler
enfriador
rafraîchisseur



matt poliert, taillierte Form, doppelwandig für beste Isolierung, für 0,5 - 1,5 Liter-Flaschen
 satin polished finish, waisted form, double wall, for 0,5 - 1,5 ltr. bottles
 acabado pulido mate, diseño „entallado“, con doble pared para botellas de 0,5 a 1,5 l.
 inox mat, forme design, double paroi pour une meilleure conservation de la température, pour bouteilles de 0,5 a 1,5 L.

| | ☐ cm | ↑ cm |
|---------|-------------|------|
| 36038 9 | Ø 12,5 / 10 | 19 |



Flaschenkühler „CLASSIC“
bottle cooler
enfriador
rafraîchisseur



edler Kunststoffmantel in matt-metall Optik, Rand hochglanzpoliert, speziell isolierter Kunststoffeinsatz sorgt für beste Kühlung, für 0,5 - 1,5 Liter-Flaschen, Material: Mylar

noble plastic jacket in satin metal look, mirror polished finish edge, special insulated plastic insert, for 0,5 - 1,5 ltr. bottles

plástico imitación metal aspecto satinado, borde brillante, aislado interior especial para botellas de 0,5 a 1,5 ltr.

plastique aspect métal satiné, bord brillant, paroi intérieure spécialement isolante pour bouteilles de 0,5 à 1,5 L

| | ☐ cm | ↑ cm |
|---------|--------|------|
| 36036 5 | Ø 12,5 | 22 |

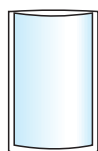

doppelwandig
double wall



Flaschenkühler
bottle cooler
enfriador
rafraîchisseur

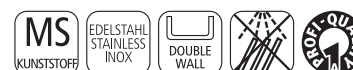

Rand matt poliert, doppelwandig für beste Isolierung, für 0,7 - 1,5 Liter Flaschen, Größe außen Ø 11,5 cm, Größe innen Ø 9,5 cm

satin polished finish edge, double wall cooler keeps the temperature for a long time, for 0,7 - 1,5 ltr. bottles, size outside Ø 11,5 cm, size inside Ø 9,5 cm

borde pulido satinado, con doble pared para mantener más tiempo la temperatura para botellas de 0,7 a 1,5 l., medida exterior 11,5 cm, medida interior 9,5 cm

bord métallique mat, double paroi pour excellente conservation de la température, pour bouteilles de 0,7 a 1,5 L. Ø ext. 11,5cm, Ø int. 9,5 cm

| | ☐ cm | ↑ cm |
|---------|--------------|------|
| 36050 1 | Ø 11,5 / 9,5 | 23 |

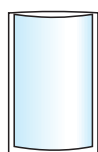

doppelwandig
double wall



Flaschenkühler „ICE“
bottle cooler
enfriador
rafraîchisseur

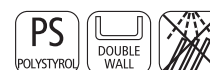

transparent gefrostet, doppelwandig für beste Isolierung, ergonomische Rundung für eine bessere Handhabung, für 0,7 - 1,5 Liter Flaschen, Design patentiert, Größe außen Ø 14 cm, Größe innen Ø 10 cm

transparent frosted, double wall cooler keeps the temperature for a long time, ergonomic rounded for a better handling, for 0,7 - 1,5 ltr. bottles, design patented, size outside Ø 14 cm, size inside Ø 10 cm

transparente glaseado la doble pared mantiene la temperatura durante mucho tiempo, diseño redondeado ergonómico para una mejor sujeción, plástico transparente satinado, para botellas de 0,7 - 15, diseño patentado, exterior 14 cm. Interior 10 cm

transparent satiné, design breveté ergonomique pour facile préhension, double paroi pour excellente conservation de la température, pour bouteilles de 0,7 a 1,5 L. Ø ext. 14 cm, Ø int. 10 cm

| | ☐ cm | ↑ cm |
|---------|-----------|------|
| 36042 6 | Ø 14 / 10 | 23,5 |

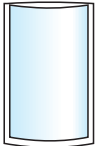

HOT PRICE

doppelwandig
double wall



36032



36034

**Flaschenkühler
bottle cooler
enfriador
rafraîchisseur**



transparent, doppelwandig für beste Isolierung, mit Chromrand, Größe außen Ø 12 cm, Größe innen Ø 10 cm

transparent, double wall cooler keeps the temperature for a long time, with chrome edge, size outside Ø 12 cm, size inside Ø 10 cm

transparente, doble pared mantiene la temperatura por largo tiempo, borde superior cromado, medida exterior diam.12 cm, interior diam.10 cm.

transparent, bord chromé brillant, double paroi pour maintien en température, Ø ext. 12 cm, Ø int. 10 cm

| | ☐ cm | ↑ cm | | |
|---------|-----------|------|---|------------------|
| 36032 7 | Ø 12 / 10 | 23 | ● | transparent |
| 36034 1 | Ø 12 / 10 | 23 | ● | blau-transparent |



**Flaschenkühler
bottle cooler
enfriador
rafraîchisseur**



doppelwandig für beste Isolierung

double wall cooler keeps the temperature for a long time

doble pared para mantener el frigo largo tiempo

double paroi pour une meilleure conservation de la température

| | ☐ cm | ↑ cm |
|---------|-----------|------|
| 36064 8 | Ø 13 / 10 | 22,5 |



**Pitcher „CLASSIC“
pitcher
jarra
pichet**



| | ☐ cm | ↑ cm | ltr. |
|---------|------|------|------|
| 93105 3 | Ø 13 | 21 | 1,5 |





Kühlmanschette „CHAMPAGNE“
cool collar
funda enfriadora
manchette rafraîchissante



Aktivkühler, ohne Eis, nach 5 Minuten gekühlt, Aufbewahrung im Gefrierfach
 Active chiller without ice, chilled in 5 minutes, keep in freezer
 Enfria sin hielo en sólo 5 minutos. Guardar en el congelador
 Refroidit en 5 minutes, sans glace. Conserver au congélateur

| | ☐ cm | ↑ cm | |
|---------|----------|------|---|
| 36085 3 | 16 x 2,5 | 22 | ● |
| 36086 0 | 16 x 2,5 | 22 | ● |

für Sekt- und Champagnerflaschen / for champagnebottles



Kühlmanschette „WINE“
cool collar
funda enfriadora
manchette rafraîchissante



Aktivkühler, ohne Eis, nach 5 Minuten gekühlt, Aufbewahrung im Gefrierfach
 active chiller without ice, chilled in 5 minutes, keep in the freezer
 Enfria sin hielo en sólo 5 minutos. Guardar en el congelador
 Refroidit en 5 minutes, sans glace. Conserver au congélateur

| | ☐ cm | ↑ cm | |
|---------|--------|------|---|
| 36083 9 | 14 x 2 | 17,5 | ● |
| 36084 6 | 14 x 2 | 17,5 | ● |

für Mineralwasser- und Weinflaschen / for winebottles



Kühlmanschette
cool collar
funda de frío
housses isotherme



für Sekt- / Champagnerflaschen, einfach im Gefrierfach einfrieren, komplette Flasche wird in 5 Min. auf angenehme Trinktemperatur gekühlt, außen reißfestes Stoffgewebe, innen Kunststoff mit Kühlgel gefüllt, unbegrenzt wiederverwendbar

for bottles of champagne, simply to freeze in the freezer, complete bottles will be cooled down in only 5 minutes, tearproof cloth outside, plastic filled with gel inside, unlimited reusable

para botellas de cava o champán simplemente congelándola en el congelador, la botella entera se enfriará en 5 minutos. Funda de plástico muy robusta, rellena con un gel congelante reutilizable ilimitadamente.

pour bouteilles de vin ou champagne. La housse est préalablement stockée au congélateur. où elle accumule le froid. Ensuite elle refroidit uen bouteille en quelques minutes. Plastique résistant, contient un liquide congelant, à réutiliser de façon illimitée.

| | ☐ cm | ↑ cm |
|---------|------|------|
| 36075 4 | Ø 11 | 18 |

für Sekt- und Champagnerflaschen / for champagnebottles



5 Liter
8 Liter

Eisbox „MAXI“
ice box
cubitera
seau à glaçons



Aluminium eloxiert
 aluminium anodised
 aluminio anodizado
 aluminium anodisé

| | ☐ cm | ↑ cm | ltr. |
|---------|--------|------|------|
| 36033 4 | Ø 18,5 | 20 | 5 |
| 36037 2 | Ø 27 | 20 | 8 |

2 Größen

EAN = 40 04 133 XXXX X

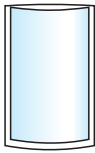

doppelwandig
double wall



mit Eiszange

Eisheimer-Set mit Eiszange
ice bucket set with tong
cubitera isotérmica
seau à glaçons isothermique



Deckel hochglanzpoliert, Behälter matt poliert, inkl. Edelstahl-Eiszange
cover mirror polished finish, container satin polished finish, incl. stainless steel tong
tapa pulida efecto brillante, con doble pared con pinza de hielo.
couverture brillant, double paroi, avec pince à glaçons

| | cm | cm | litr. |
|---------|------|----|-------|
| 36013 6 | Ø 12 | 14 | 1 |



36024
3 Liter

mit Eiszange

36022
1,5 Liter

Eisheimer mit Eiszange „CLASSIC“
ice bucket
cubitera
seau à glaçons



edler Kunststoffmantel in matt-metall Optik, Rand hochglanzpoliert, Tragebügel transparent, speziell isolierter Kunststoffeinsatz sorgt für beste Kühlung, Kunststoffdeckel klar
noble plastic jacket in satin metal look, with mirror polished finish edge, handle transparent, special insulated plastic insert, transparent plastic cover
plástico aspecto metálico satinado, borde brillante, asa transparente, interior plástico aislante especial, tapa de plástico transparente.
plastique aspect métal satiné, bord brillant, anse transparente, paroi intérieure spécialement isolante, couvercle transparent

| | cm | cm | litr. |
|---------|------|----|-------|
| 36022 8 | Ø 15 | 15 | 1,5 |
| 36024 2 | Ø 20 | 18 | 3 |



mit Eiszange

Eisheimer-Set mit Eiszange „CLASSIC“
ice bucket set with tong
cubitera clásica con pinza
seau à glaçons classique avec pince



hochglanzpoliert, edler Kunststoffmantel, inkl. Edelstahl-Eiszange und Abtropfgitter mit Tragebügel, speziell isolierter Kunststoffeinsatz sorgt für beste Kühlung
mirror polished finish, noble plastic jacket, highly plated, incl. stainless steel tong and drainer, with handle, special insulated plastic insert for best cooling
exterior de plástico de alta calidad de aspecto metálico mate, incluye pinza de inox. Plástico interior aislante especial.

plastique aspect métal brillant, bonne qualité, avec pince inox et égouttoir, paroi intérieure spécialement isolante

| | cm | cm | litr. |
|---------|------|----|-------|
| 36015 0 | Ø 14 | 22 | 1,3 |



36029
3 Liter

mit Eiszange

36027
1,5 Liter

Eisheimer mit Eiszange „WEISS“
ice bucket
cubitera
seau à glaçons



weißer Kunststoffmantel, Kunststoff-Tragebügel, speziell isolierter Kunststoffeinsatz sorgt für beste Kühlung, Kunststoffdeckel klar, inkl. Eiszange
white plastic jacket, plastic handle, special insulated plastic insert, for best cooling, transparent plastic cover, incl. tong
cubitera blanca, asa de plástico blanco, interior aislante especial con tapa transparente, con pinza
seau à glaçons, anse en plastique blanc, paroi intérieure spécialement isolante, couvercle transparent, avec pince

| | cm | cm | litr. |
|---------|------|----|-------|
| 36027 3 | Ø 15 | 15 | 1,5 |
| 36029 7 | Ø 20 | 18 | 3 |

designed by **CULTURE FORM**



Eisbox
icebox
cubitera
seau à glaçons



mit herausnehmbarem Tropfeinsatz
with drainer
plástico interior aislante especial
égouttoir

| | □ cm | ↑ cm | ltr. |
|---------|---------|------|------|
| 93220 3 | 27 x 27 | 15 | 5,4 |



5,4 Liter



3,4 Liter

Inneneinsatz trennt
Wasser und Eis

Eisbox
icebox
cubitera
seau à glaçons



Lieferung ohne Schaufel und Eiszerkleinerer
delivery without scoop
entrega sin pala
livré sans la pelle

| | □ cm | ↑ cm | ltr. |
|---------|---------|------|------|
| 93200 5 | 20 x 20 | 17 | 3,4 |



Glasumrander
glass rimmer
ribeteador de vasos
bordeur à verres „rimmer“



Schwamm für Limettensaft, 2 Fächer für Zucker und Salz
with sponge for lime juice, 2 cases for sugar and salt
con esponja para zumo de lima, 2 compartimentos para azúcar y sal
avec éponge et 2 compartiments pour sucre et sel

| | □ cm |
|---------|----------|
| 93175 6 | 20 x 7,5 |



Bar-Caddy
bar caddy
organizador de bar
organisateur „bar caddy“



Ordnungshilfe für Trinkhalme, Rührer, Servietten, Streichhölzer, etc., ohne Inhalt
 to organize straws, stirrers, napkins, matches, etc.
 para organizar pajitas, cucharillas, servilletas, cerillas, etc.
 pour bien organiser les pailles, agitateurs, cuillers, serviettes et autres accessoires

| | ☐ cm | ↑ cm | |
|---------|---------|------|---|
| 93174 9 | 24 x 15 | 11 | ● |



Eiszerkleinerer
Ice crusher
picadora de hielo
broyeur à glaçons



inkl. Behälter und Eisschaufel, mit Edelstahl-Messer, glänzend
 with container and ice scoop, stainless cutters
 con depósito y pala para el hielo, metal cromado
 avec tiroir récupérateur et pelle, métal chromé

| | ☐ cm | ↑ cm |
|---------|---------|------|
| 36009 9 | 16 x 13 | 27 |



Eiszerkleinerer
Ice crusher
picadora de hielo
broyeur à glaçons



glasklar, mit Edelstahl-Messer
 clear, stainless steel cutters
 cuchillas de acero inoxidable
 couteaux inox

| | ☐ cm | ↑ cm |
|---------|---------|------|
| 36017 4 | 12 x 12 | 24 |



Ø 5,5 cm

einfach mit Wasser füllen
 und gefrieren lassen

Eis-Kugel-Formen
ice ball former
molde de cubitos de hielo esféricos
moule à glaçons en boules



2 tlg., 3 Kugeln á 100 ml
 3 bowls á 100 ml
 3 bolas 100 ml
 3 boules 100 ml

| | ☐ cm | ↑ cm |
|---------|------------|------|
| 12990 0 | 23,5 x 8,5 | 6,5 |





93182

**Stößel
muddler
mortero
pilon muddler plastique**



grober Stößel, zum Auspressen von Früchten und Zerstoßen von Würfelzucker
coarse notched, to press fruits or pound lump sugar
mortero grueso con muescas para exprimir frutas y machacar azucarillos
muddler grand format avec bout relief étoile pour presser les fruits ou le sucre en morceaux

| | cm | → cm | |
|---------|-----|------|---|
| 93182 4 | Ø 4 | 24 | ● |



93183

**Stößel „BIG“
muddler
mortero
pilon muddler „BIG“**



POM mit Edelstahl-Kappe, flacher, glatter Stößel, zum Auspressen von Früchten und Zerstoßen von Würfelzucker
flat surface, to press fruits or pound lump sugar
superficie lisa para exprimir frutas y machacar azucarillos
muddler grand format avec bout lisse pour presser les fruits ou le sucre en morceaux

| | cm | → cm | |
|---------|-------|------|---|
| 93183 1 | Ø 4,5 | 25 | ● |



93180

**Stößel
muddler
mortero
pilon de bar**



mit griffigem Ende, zum Auspressen von Früchten und Zerstoßen von Würfelzucker
with handy end, to press fruits or pound lump sugar
acabado relieve para prensar frutas o azucar
avec relief grillagé pour presser les fruits ou le sucre en morceaux

| | cm | → cm | |
|---------|-------|------|--|
| 93180 0 | Ø 2,5 | 21 | |
| 93181 7 | Ø 2,5 | 21 | |



93181



**Cocktailmesser
bar knife
cuchillo para cóctel
couteau cocktail**



mit 2 Zinken zum Aufspießen von Zitrusseiben
with 2 prongs to pick up slices of lemon
con 2 dientes para pinchar las rodajas de limón, etc.
avec 2 dents pour les rondelles de citron et autres décorations

| | → cm |
|---------|------|
| 88846 3 | 21 |

NEW



Tablett „CROCO“
Tray
Bandeja
Plat



Edelstahl, hochglänzend, doppelwandig, innen: Krokodillederoptik
 stainless-steel, mirror polished finish, double-wall
 acero inoxidable, pulido brillante, doble pared
 inox, brillant, double paroi

| | | |
|---------|------|--|
| | cm | |
| 01337 7 | Ø 32 | |



Tablett
tray
bandeja
plateau



mit gebördeltem polierten Rand
 rolled mirror polished finish edge
 borde redondeado acabado efecto espejo
 bord rond, effet miroir

| | | |
|---------|------|------|
| | cm | ↑ cm |
| 01336 0 | Ø 35 | 3 |



Bar-Set
bar-set
conjunto de bar
set pour le bar



matt poliert, 5-teilig: Barsieb + Eiszange + Öffner + Messer + Ständer
 satin polished finish, 5 pcs. set: strainer + ice tong + opener + knife + stand
 acabado pulido satinado: 5 elementos, colador, pinza para hielo, abridor, cuchillo, soporte.
 fini mat satiné, 5 pièces: passoire à cocktail, pince à glace, décapsuleur, couteau, rack support.

| | | |
|---------|--------|------|
| | cm | ↑ cm |
| 36012 9 | 13 x 7 | 20 |



Boston Shaker
boston shaker
coctelera boston
shaker boston



2-teilig: Becher, 700 ml, gummiert, rutschfest + Glas, 400 ml
 2 pcs. set: beaker, 700 ml, rubberized, anti-slip + glass, 400 ml
 conjunto de 2 piezas: vaso coctelero con goma exterior 700ml + vaso de vidrio 400 ml
 2 pièces: bol mélangeur inox extérieur plastifié couleur 700 ml + bol en verre 400 ml

| | | | | |
|---------|-----|------|------|---|
| | cm | ↑ cm | ltr. | |
| 93139 8 | Ø 9 | 30 | 0,7 | ● |
| 93136 7 | Ø 9 | 30 | 0,7 | ● |
| 93137 4 | Ø 9 | 30 | 0,7 | ● |

Einzelteile / spare parts / piezas sueltas / pièces détachées

Ersatzglas / spare glass / recambio vaso / verre de rechange

| | | | |
|---------|-------|------|-----|
| 93138 1 | Ø 8,5 | 14,5 | 0,4 |
|---------|-------|------|-----|



Speed Shaker
boston shaker
coctelera boston
shaker boston



matt poliert, Größe oben Ø 8 cm, Größe unten Ø 6 cm
satin polished finish, size top Ø 8 cm, size bottom Ø 6 cm
pulido acabado satinado, arriba Ø 8 cm, medida abajo Ø 6 cm.
poli mat satiné, Ø sup. 8 cm, Ø inf. 6 cm

| | □ cm | ↑ cm | ltr. |
|---------|------|------|------|
| 36007 5 | Ø 8 | 11,5 | 0,4 |



Boston Shaker
boston shaker
coctelera boston
shaker boston



2-teilig: Becher, hochglanzpoliert, 700 ml + Glas, 400 ml
2 pcs. set: beaker, mirror polished finish, 700 ml + glass, 400 ml
set de 2 piezas: vaso coctelero, pulido acabado brillante 700 ml+ vaso vidrio 400 ml
2 pièces: bol mélangeur inox brillant 700 ml + bol en verre 400 ml

| | □ cm | ↑ cm | ltr. |
|---------|------|------|------|
| 93140 4 | Ø 9 | 30 | 0,7 |

Einzelteile / spare parts / piezas sueltas / pièces détachées

Ersatzglas / spare glass / recambio vaso / verre de rechange

| | | | |
|---------|-------|------|-----|
| 93138 1 | Ø 8,5 | 14,5 | 0,4 |
|---------|-------|------|-----|



Shaker
shaker
coctelera
shaker



hochglanzpoliert
mirror polished finish
acabado pulido brillante
brillant

| | □ cm | ↑ cm | ltr. |
|---------|-------|------|------|
| 36010 5 | Ø 8,5 | 20 | 0,5 |
| 36011 2 | Ø 9 | 23 | 0,7 |



Rührglas mit Lippe
mixing glass with lip
vaso mezclador vertedor con pico
verre mélangeur avec bec verseur



schwere Qualität
heavy quality
alta calidad
qualité renforcée

| | □ cm | ↑ cm | ltr. |
|---------|--------|------|------|
| 93101 5 | Ø 11,5 | 19 | 0,95 |



**Cocktail-Doppelmaß
jigger
medidor
measure double „jigger“**



| | □ cm | ↑ cm | ltr. |
|---------|-----------|------|-------------|
| 93120 6 | Ø 4,5 / 4 | 7,0 | 0,02 / 0,04 |



**Cocktail-Doppelmaß
jigger
medidor
measure double „jigger“**



| | □ cm | ↑ cm | ltr. |
|---------|-----------|------|--------------|
| 93121 3 | Ø 4 / 3,5 | 8,5 | 0,02 / 0,04 |
| 93112 1 | Ø 4 | 8,5 | 0,025 / 0,05 |



**Cocktail-Doppelmaß
jigger
medidor
measure double „jigger“**



hochglanzpoliert, schnelles und genaues Abmessen von Spirituosen
mirror polished finish, quick and exact measuring of spirits
rápida y exacta medición de licores y otros ingredientes.
measure exacte et rapide pour alcool et autres ingrédients

| | □ cm | ↑ cm | ltr. |
|---------|---------|------|-------------|
| 93116 9 | Ø 6 / 5 | 6 | 0,02 / 0,04 |

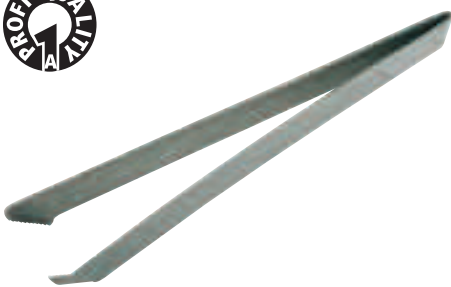

**Eiszange
ice tong
pinza para cubitos de hielo
pince à glaçons**



matt poliert, mit griffigem Ende, ideal für Eiswürfel und Obstscheiben
satin polished finish, with handy end, ideal for ice cubes and fruit slices
pulido satinado, forma ergonómica ideal para cubitos de hielo y láminas de fruta
poli mat satiné, forme ergonomique idéale pour glaçons et fruits tranchés

| | □ cm | → cm |
|---------|---------|------|
| 93190 9 | 2 x 1,5 | 20 |

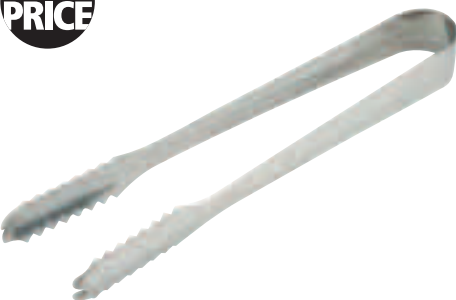

**Eiszange
ice cube tong
pinza de hielo
pince à glaçons**



hochglanzpoliert, fugenlos
mirror polished finish, seamless
pulido acabado brillante, de una sola pieza
brillant, d'une seule pièce

| | □ cm | → cm |
|---------|-------|------|
| 75805 6 | 5 x 2 | 17,5 |



mit gedrehtem Stiel

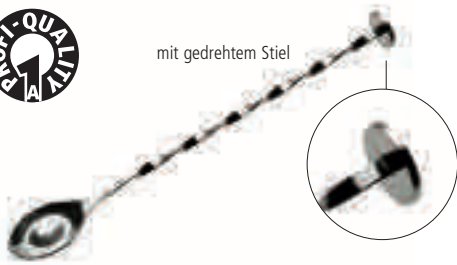

**Bar-Löffel
cocktail spoon
cucharilla de cóctel
cuillère à cocktail**

mit flachem Stößel am Kopfende
with flat muddler at the top end
mango con final en mazo
manche avec bouton massif „pilon“

→ cm

93128 2 27



mit gedrehtem Stiel

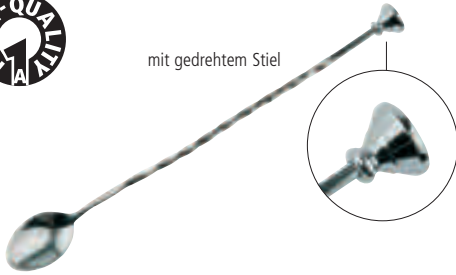

**Bar-Löffel
bar spoon
cucharilla de cóctel
cuillère à cocktail**

mit Kegel-Stößel am Kopfende
with muddler at the top end
mango con final en mazo
manche avec bouton massif „pilon“

→ cm

93134 3 27



mit gedrehtem Stiel

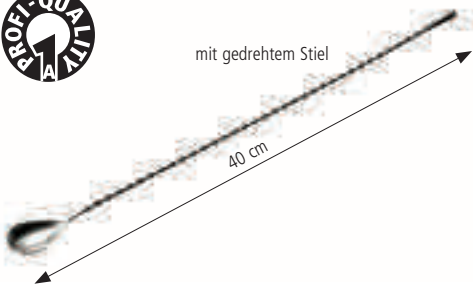

**Bar-Löffel
cocktail spoon
cucharilla de cóctel
cuillère à cocktail**

→ cm

93153 4 40



mit gedrehtem Stiel

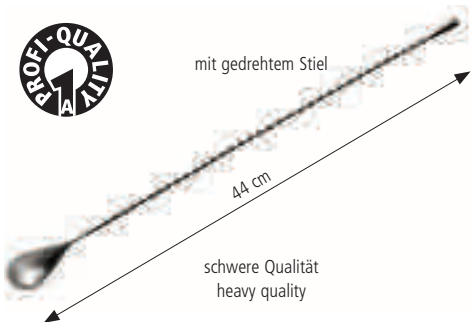

**Bar-Löffel
cocktail spoon
cucharilla de cóctel
cuillère à cocktail**

→ cm

93129 9 44



mit gedrehtem Stiel

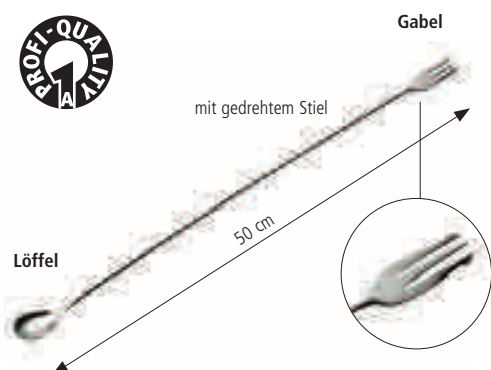

**Bar-Löffel / -Gabel
cocktail spoon / fork
cucharilla de cóctel
cuillère à cocktail**

→ cm

93152 7 50





Eisschaufel
ice scoop
pala de hielo
pelle à glaçons



| | cm | → cm | ltr. | |
|---------|--------|------|------|---|
| 93192 3 | 10 x 6 | 29 | 0,7 | ● |



Eisschaufel
ice scoop
pala de hielo
pelle à glaçons



gelocht, ideal zum Befüllen von schlanken Gläsern, Schmelzwasser fließt zurück in die Eisbox
perforated, ideal to fill narrow glasses, melt water flows back into the ice box
perforada, ideal para llenar vasos estrechos el agua derretida cae en la caja de hielo
perforée, idéale pour verser les glaçons dans des verres étroits, l'eau retombe dans le bac à glaçons

| | cm | → cm |
|---------|-----|------|
| 93191 6 | Ø 5 | 19 |



Korkenzieher
waiter's corkscrew
sacacorchos de camarero
tire-bouchons



leichtgängige Teflon-Spirale, mehrstufige Klapphebelfunktion, am Kopf angebrachtes Messer
easy moving teflon coil, 2-stage opening system, knife at the top end
mecha de teflón, sistema de apertura en 2 golpes, con cuchilla en la parte superior
mèche téflon, ouverture en 2 étapes, couteau dans la partie supérieure

| | → cm |
|---------|------|
| 93301 9 | 12 |

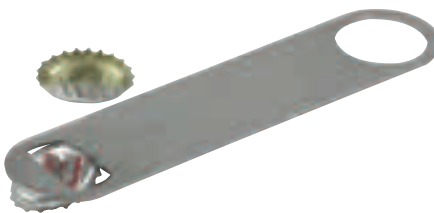

Kellner-Flaschenöffner
waiter's barblade
abridor camarero
décapsuleur



matt poliert
satin polished finish
pulido acabado mate
poli mat

| | cm |
|---------|--------|
| 93122 0 | 18 x 4 |



mit Gummierung

Kellner-Flaschenöffner
waiter's barblade
abridor camarero
décapsuleur



| | cm |
|---------|--------|
| 93125 1 | 11 x 4 |



Korkenzieher „TWISTER“
waiter's corkscrew
sacacorchos de camarero
tire-bouchons sommelier



patentierter „Bottle Grip“, einfache Handhabung, drehen der Spirale bis der Korken entfernt ist, passt auf alle Weinflaschen

patented „Bottle Grip“, simple to use, twist the spiral until the cork is extracted, fits all wine bottles

„Sistema de Agarre“ patentado, facil manejo, sistema de giro continuo, apto para todas las botellas de vino

| | | |
|---------|---------|------|
| | ☐ cm | ↑ cm |
| 93296 8 | 7,5 x 5 | 20 |



Kronkorkenöffner
bottle cap opener
abridor de chapas de pared
décapsuleur mural



für die Wandmontage, aus massivem Metall

for wall fastening, massive metal

para fijación en pared, metal macizo

massif, à fixer au mur

| | | |
|---------|-------|------|
| | ☐ cm | ↑ cm |
| 93124 4 | 7 x 8 | 2,5 |



Kronkorken-Sammelbehälter
bottle cap holder
recogedor de chapas
bac récupérateur de capsules



matt poliert, für die Wandmontage unterhalb des Kronkorkenöffners

satín polished finish, for wall fastening beyond the opener

para fijar en la pared debajo del abridor, para recoger las chapas.

à fixer au mur sous le décapsuleur mural

| | | |
|---------|----------|------|
| | ☐ cm | ↑ cm |
| 93172 5 | 13,5 x 8 | 24 |



Korkenzieher
corkscrew
sacacorchos
tire-bouchons



durch die ausgefeilte Technik und den großen Holzhebel lässt sich eine Weinflasche mühelos mit zwei schnellen Bewegungen öffnen, schwere Profi-Qualität, Grifflänge 13,5 cm

a wine bottle can easily be opened with two quick actions due to the sophisticated technique and the large wooden lever, heavy professional quality, handle length 13,5 cm

para profesionales de la gastronomía y del vino, una botella se abre fácilmente con sólo dos gestos, gracias a un eficaz mecanismo y a una palanca de 13,5 cm., alta calidad profesional
une bouteille s'ouvre simplement en 2 gestes avec son mécanisme sophistiqué et pratique, avec un levier de 13,5 cm, pour les professionnels de la gastronomie et du vin

| | |
|---------|------|
| | → cm |
| 93299 9 | 53 |



**Ananasschneider „PROFI“
pineapple slicer+wedger
pelador y cortador de piña
pèle-ananas et coupe-quartiers**



Schnell und einfach, mit separate Portionierer, Benutzung für Ringe oder Stücke in Sekunden, entfernt den Kern, Griff kann mit einer Bewegung entfernt werden, Schale wird nicht beschädigt

Quick and easy, with separate wedge cutter. Peels, removes the core and cuts in perfect rings in a few seconds. Moreover, if you wish, you can finish the operation using the separate wedger to cut the entire pineapple in chunks in one movement. The handle of the slicer is removable to release easily the pineapple rings out of the slicer. The pineapple shell remains intact for original presentations

Pela, descorazona y corta a rodajas en unos segundos. Además, si lo desea, puede terminar cortando la piña entera a gajos en sólo unos segundos con el accesorio cortador de gajos. Ventaja: cuando retira el pelador cortador, la cáscara queda entera y se puede utilizar para originales presentaciones. Truco: el mango se desmonta pulsando un botón para poder sacar las rodajas con facilidad

Idéal pour peler, évider et trancher en une seule opération. De plus, si souhaité, coupe en 1 seul geste l'ananas entier en cubes grâce à l'accessoire additionnel coupe-quartiers. Le manche se démonte avec un bouton pour pouvoir facilement récupérer les tranches. Avantage : après la coupe, l'ananas évidé peut être utilisé pour une présentation originale

| | ☐ cm | ↑ cm |
|---------|----------|------|
| 88860 9 | 11 x 8,5 | 22,5 |



**Zitronenpresse
citrus squeezer
exprimidor cítricos
presse-citron**



hochglanzpoliert, 2-teilig
mirror polished finish, 2 pcs.
pulido brillante, 2 piezas
brillant, 2 pièces

| | ☐ cm | ↑ cm | ltr. |
|---------|-----------|------|------|
| 71431 1 | Ø 12 / 17 | 10,5 | 0,35 |



**Bar-Sieb
bar strainer
colador de cóctel
tamis cocktail**



hochglanzpoliert, Spiralfeder hält Eiswürfel beim Abseihen zurück, Feder kann zur Reinigung entnommen werden, passend für alle Gläser und Shaker

mirror polished finish, coil spring keeps ice cubes in shaker, spring can be taken off for cleaning, suitable for all glasses and shakers

pulido acabado brillante, con muelle para mantener los cubitos en la coctelera, el muelle se desmonta para limpiar. Se adapta a todos tipos de vasos y cocteleras

brillant, avec ressort pour garder les glaçons dans le shaker. Ressort démontable pour lavage. S'adapte à tous types de verres mélangeurs et shakers

| | ☐ cm | → cm |
|---------|--------|------|
| 93300 2 | 11 x 2 | 15 |



**Limettenpresse
lime press
prensa de limón/lima
presse citron**



| | ☐ cm | ↑ cm | ● |
|---------|--------|------|---|
| 93189 3 | 21 x 7 | 5 | ● |

Limette teilen, flache Seite in die Pressenhälfte legen und Saft auspressen



Zitruspresse „PROFI“
juicer
exprimidor
presse-agrumes



Zinkdruckguß verchromt, sehr stabile Ausführung, müheloses Entsaften durch Hebelmechanismus, extra Ausgießtülle für tropffreies Pressen, Sieb fängt Kerne und Fruchtfleisch auf, möbelschonende GummifüÙe

zinc alloy chrome plated, stable and robust mechanism.

fundición a base de aleación de zinc, cromado, alta calidad, reforzado y con mecanismo robusto y muy limpio, sin esfuerzo. Pie revestido para no rallar la mesa de trabajo

fonte de zinc chromé, qualité renforcée, mécanique robuste et simple d'usage, sans effort

| | ☐ cm | ↑ cm |
|---------|---------|------|
| 36014 3 | 26 x 20 | 48 |

Zitruspresse
juicer
exprimidor
presse-agrumes



Zinkdruckguß verchromt, mit Hebelmechanismus, äußerst standfest und robust, müheloses Entsaften durch Hebelmechanik, Sieb fängt Kerne und Fruchtfleisch auf, möbelschonende GummifüÙe

made from high quality steel, finished in chrome, stable and robust mechanism, non-scratching undersurface

super-profesional, fundición a base de aleación de zinc, cromado, alta calidad, reforzado y con mecanismo robusto y muy limpio, sin esfuerzo. Pie revestido para no rallar la mesa de trabajo

super professionnel, fonte de zinc chromé, qualité renforcée, mécanique robuste et simple d'usage, sans effort

| | ☐ cm | ↑ cm |
|---------|---------|---------|
| 36019 8 | 19 x 18 | max. 56 |





Dosier- & Vorratsflasche
pouring container
botella „store & pour“
bouteille „store & pour“

4-teilig: Behälter + Flaschenhals + Schraubdeckel + Ausgießer mit Luftzufuhr für gezieltes Ausgießen, zum Dosieren und Aufbewahren

4 pcs. set for storage, mixing and serving drinks

set de 4 piezas para almacenar y servir mezclas y bebidas

se compose de 4 pièces. Idéal pour servir et pour conserver les boissons

6 Farben

2 ltr.



zum Dosieren
und Aufbewahren

| | □ cm | ↑ cm | ltr. | |
|---------|--------|------|------|-----------------|
| 94144 1 | Ø 12,5 | 35 | 2,0 | ● gelb/yellow |
| 94145 8 | Ø 12,5 | 35 | 2,0 | ● rot/red |
| 94146 5 | Ø 12,5 | 35 | 2,0 | ● grün/green |
| 94147 2 | Ø 12,5 | 35 | 2,0 | ○ klar/clear |
| 94148 9 | Ø 12,5 | 35 | 2,0 | ● orange |
| 94149 6 | Ø 12,5 | 35 | 2,0 | ● braun / brown |



Dosier- & Vorratsflasche
pouring container
botella „store & pour“
bouteille „store & pour“

4-teilig: Behälter + Flaschenhals + Schraubdeckel + Ausgießer Ø 11 mm mit Luftzufuhr für gezieltes Ausgießen, zum Dosieren und Aufbewahren

4 pcs. set for storage, mixing and serving drinks, nozzle Ø 11 mm

set de 4 piezas para almacenar y servir mezclas y bebidas, agujero de diam. 11 mm.

se compose de 4 pièces. Idéal pour servir et pour conserver les boissons, embout Ø 11 mm

zum Dosieren
und Aufbewahren

1 ltr.

6 Farben



abnehmbarer Boden
dient als Deckel

| | □ cm | ↑ cm | ltr. | |
|---------|------|------|------|-----------------|
| 93144 2 | Ø 9 | 33 | 1 | ● gelb / yellow |
| 93145 9 | Ø 9 | 33 | 1 | ● rot / red |
| 93146 6 | Ø 9 | 33 | 1 | ● grün / green |
| 93147 3 | Ø 9 | 33 | 1 | ○ klar / clear |
| 93148 0 | Ø 9 | 33 | 1 | ● orange |
| 93149 7 | Ø 9 | 33 | 1 | ● braun / brown |



1 ltr.

Dosier- & Vorratsflasche
pouring container
botella „store & pour“
bouteille „store & pour“



4-teilig: Behälter + Flaschenhals + Schraubdeckel + Ausgießer Ø 11 mm mit Luftzufuhr für gezieltes Ausgießen, zum Dosieren und Aufbewahren

4 pcs. set for storage, mixing and serving drinks, nozzle Ø 11 mm

4 piezas para guardar, para mezclar y servir bebidas, boquilla Ø 11 mm

se compose de 4 pièces. Idéal pour servir et pour conserver les boissons, embout Ø 11 mm

| | ☐ cm | ↑ cm | ltr. | pcs. | |
|---------|------|------|------|------|---|
| 93143 5 | Ø 9 | 33 | 1 | 4 | ● |



Verschluss, 4er Set
stopper, 4 pcs. set
taponos set de 4 unidades
bouchon, 4 a set



passend für alle APS Ausgießer der Dosier- und Vorratsflaschen

suitable for APS-pourers

valido para vertedores APS

pour verseurs APS

93142 8



für 0,2 - 0,3 ltr.

Bierglasträger
beer rack
bandeja para cerveza
porte verres à bière



für Glasgrößen 0,2 - 0,3 Liter, für 10 Gläser

for glasses size 0,2 - 0,3 liter

para vasos tamaño 0,2-0,3 l

pour verres de 0,2 à 0,3 L

| | ☐ cm | ↑ cm |
|---------|-----------|------|
| 00632 4 | 40 x 16,5 | 29 |



Flaschenträger
bottle rack
porta botellas
porte-bouteilles



für 6 Flaschen, Ring Ø 9,5 cm

for 6 bottles, ring Ø 9,5 cm

para 6 botellas, diam. 9,5 cm

pour 6 bouteilles, diam. 9,5 cm

| | ☐ cm | ↑ cm |
|---------|-----------|------|
| 00630 0 | 32 x 21,5 | 32,5 |



Gläserchiene
glass rack
rack de copas
rack porte-verres



aus 6 mm verchromten Draht, Wand- und Deckenmontage möglich, bietet Platz für 20 Gläser

6 mm chrome plated wire, can be mounted under a shelf or on the wall, for 20 glasses

alambre cromado de 6 mm, puede instalarse bajo una estantería o en la pared para 20 copas.

fil chromé de 6 mm, à installer sous une étagère ou contre un mur, pour 20 verres à pied

| | ☐ cm | ↑ cm |
|---------|---------|------|
| 93400 9 | 45 x 32 | 6 |

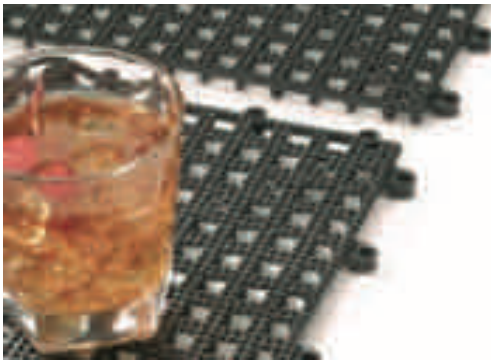

Abtropfmatte
drip mat
esterilla escurridora
tapis égouttoir pour étagères



erweiterbar durch Klick-Verbindung
 expandable
 las placas de fijan con clips
 avec clips de fixation

| | □ cm | ↑ cm | |
|---------|---------|------|-------------------|
| 93303 3 | 33 x 33 | 1,5 | ● schwarz / black |
| 93304 0 | 33 x 33 | 1,5 | ● transparent |

in 2 Farben lieferbar



Spirituosen-Dosierer 2 cl
spirit measure 2 cl
dosificador de licores
doseur à alcool 2 cl



Kunststoff mit verchromten Gehäuse, garantiert exakte Dosierung, passend für Flaschenhalterung 93298

plastic with chrome plated body, guaranteed exact apportioning, adapted for shelf bracket 93298

plástico con cuerpo cromado, perfecta construcción, proporcionador exacto 2 cl. Apto para soporte 93298

plastique et métal chromé, construction parfaite, dosage exact 2 cl. Apte pour support bouteilles ref. 93298

| | □ cm |
|---------|---------|
| 93297 5 | 14 x 10 |



Flaschenhalterung mit Portionierer 2 cl
shelf bracket with spirit measure 2 cl
soporte 1 botela con medidor licores 2 cl
support bouteille avec doseur 2 cl



Portionierkopf aus Kunststoff mit verchromten Gehäuse, garantiert exakte Dosierung, geeignet für 0,7 - 2 Liter Flaschen, mit Schraubklemme

plastic with chrome plated body, guaranteed exact apportioning, usable for 0,7 - 2 liter bottles easily fixed at the rack/shelf by screw clamp

aluminio anodizado adaptador para botella hecho de plástico con cuerpo cromado, incluye proporcionador exacto de 2 cl, apto para botellas 0,7 a 2 l., fácil fijación brida en el estante

plastique et alu anodisé pour le corps, inclut doseur avec mesure exacte 2 cl, pour bouteille de 0,7 L a 2 L, fixation sur étagère par bride à visser

| | □ cm |
|---------|---------|
| 93298 2 | 32 - 45 |



Rezeptionsglocke
ring bell
timbre
sonnette



| | □ cm | ↑ cm | |
|---------|-------|------|---|
| 71400 7 | Ø 8,5 | 6 | ● |
| 71433 5 | Ø 10 | 7,5 | ● |



Champagnerverschluss
champagne saver
Tapón vertedor
Bouchon verseur



Einschenken ohne Tropfen, patentierter "Pull Down Bottle Grip", passt auf fast alle Standard Champagner- o. Sektflaschen

Non drip serving pourer, patented "Pull Down Bottle Grip", fits most champagne bottles

Anti goteo, patentado, apto para la mayoría de botellas de Cava o Champagne

Anti-goutte, modèle déposé, apte pour la plupart de bouteilles de Champagne

| | □ cm | ↑ cm | |
|---------|-------|------|--|
| 93135 0 | 5 x 5 | 8 | |



Permanent-Ausgießer, 6er Set
free flow pourers, 6 pcs. set
vertedores continuos set 6 piezas
set de 6 bouchons verseurs continus



| | ↑ cm | pcs. |
|---------|------|------|
| 93110 7 | 6 | 6 |



Permanent-Ausgießer, 6er Set
free flow pourers, 6 pcs. set
vertedores continuos set 6 piezas
set de 6 bouchons verseurs continus



| | ↑ cm | pcs. |
|---------|------|------|
| 93114 5 | 8 | 6 |



Permanent-Ausgießer, 2er Set
free flow pourers, 2 pcs. set
vertedores continuos set 2 piezas
set de 2 bouchons verseurs continus



Portionierer 2 cl, schnelles und genaues Abmessen

2 cl, quick and exact measuring

2 cl. Medición rápida exacta

2 cl mesure exacte et rapide

| | ↑ cm | pcs. |
|---------|------|------|
| 93115 2 | 10 | 2 |



Permanent-Ausgießer, 6er Set
free flow pourers, 6 pcs. set
vertedores continuos set 6 piezas
set de 6 bouchons verseurs continus



à 2 Stück blau, rot, gelb

2 pcs of each colour: blue, red, yellow

2 piezas de cada color: azul, rojo, amarillo

2 par couleur: bleu, rouge, jaune

| | □ cm | ↑ cm | pcs. |
|---------|------|------|------|
| 93111 4 | Ø 3 | 7,5 | 6 |



**Schnappspistole
booze pistol
pistola de licores
bouchon doseur à gâchette**



auch für zuckerhaltige, dünnflüssige Liköre, passend für handelsübliche Schnapsflaschen, luftdichter Verschluss, präzise Portioniermechanik 2 cl, einfache Reinigung in lauwarmen Wasser
useable for all commercial spirit bottles, including for sweet liqueurs or liquid alcohol, airtight closing, precise dosification 2 cl, easy to clean with warm water

apto para todos los espirituosos habituales, incluso muy dulces o muy líquidos, cierre hermético, dosificación precisa 2 cl, fácil de limpiar con agua templada.

apte pour tous les spiritueux habituels du commerce, y compris très sucrés ou très liquides, fermeture hermétique, dosage précis 2 cl, lavage facile sous l'eau chaude

cm

93108 4 13 x 8



**Weinex-Ausgießer, 2er Set
wine nozzle, 2 pcs. set
vertedor de vino set de 2 piezas
set de 2 becs verseurs**



breiter Auslaufstrahl für zügiges Ausschöpfen und Lüften junger Weine, integrierter Deckel öffnet die Flasche automatisch und verschließt sie wieder beim Abstellen, inkl. 2 Adapterhülsen

acrylic plastic, wide stream for easy flow and vent the wine, integrated lid opens and closes bottle automatically, incl. 2 adapters

acrílico baja altura para guardarlo mejor en la nevera, boca ancha para un mejor vertido y aireado del vino la tapa integrada se abre y cierra automáticamente la botella incluye 2 adaptadores.

acrylique, hauteur réduite pour l'espace dans le frigo, embouchure large pour bien verser et en même temps oxygéner les vins jeunes. La valve intégrée s'ouvre et se ferme automatiquement. Inclut 2 adaptateurs

cm

↑ cm

93109 1 Ø 3 10

**Champagner- / Sektkonservator
champagne conservator
tapón conservador
bouchon de conservation**



2-teilig: Überdruckpumpe + luftdichter Bügelverschluss mit Entlüftungsventil, Champagner und Sekt lassen sich nach dem Öffnen für längere Zeit frisch halten

2 pcs. set: overpressure pump + airtight swing-top with air valve, opened champagne and sparkling wine can be kept fresh for a longer time

set de 2 piezas, bomba a presión + tapón swing hermético con válvula de aire acero inox y plástico el cava y las bebidas espumosas pueden conservarse y mantenerse por más tiempo.

set de 2 pièces, bombe à pression + bouchon swing hermétique avec valve - inox et plastique - enfin un moyen de conserver plus longtemps le Champagne et autres vins mousseux

cm

↑ cm

93126 8 Ø 4,5 12 ●

Einzelteile / spare parts / piezas sueltas / pièces détachées

Verschluss einzeln / stopper single / tapón individual / bouchon seul

93127 5



EAN = 40 04 133 XXXXX X



Inhalt: 2 Stück
"WINE"

Wein-Verschlüsse, 2er Set
wine stopper, 2 pcs. set
2 tapones para vino
2 bouchons pour le vin



matt poliert, innen Kunststoff, mit Schriftzug „WINE“
satin polished finish, inside plastic, with inscription „WINE“
acabado pulido mate, interior de plástico con inscripción „WINE“
poli mat satiné, intérieur plastique, avec inscription "WINE"

| | ☐ cm | ↑ cm | pcs. |
|---------|-------|------|------|
| 93206 7 | Ø 4,3 | 4,5 | 2 |

2 Ausführungen:
Champagner und Sekt



Inhalt: 2 Stück

Champagner-Verschlüsse, 2er Set
stopper, 2 pcs. set
tapón para el cava, set de 2 piezas
set de 2 bouchons à champagne



matt poliert, innen Kunststoff, mit Schriftzug
satin polished finish, inside plastic, with inscription
acabado pulido mate interior de plástico
poli mat satiné, intérieur plastique avec inscription

| | ☐ cm | ↑ cm |
|---------|-------|------|
| 93207 4 | Ø 4,5 | 4,5 |



Sekt-Verschlüsse, 2er Set
stopper, 2 pcs. set
set de 2 tapones
set de 2 bouchons



hochglanzpoliert, innen Gummi Arabicum
mirror polished finish, inside rubber arabicum, with inscription
pulido acabado efecto brillante, interior goma arábica con inscripción
brillant, intérieur gomme arabique

| | ☐ cm | ↑ cm | pcs. |
|---------|------|------|------|
| 93160 2 | Ø 4 | 6 | 2 |



Wein-Verschluss
wine stopper
tapón para vino
bouchon à vin



matt poliert
satin polished finish
acabado pulido mate
poli mat satiné

| | ☐ cm | ↑ cm |
|---------|-------|------|
| 93202 9 | Ø 4,3 | 6,3 |

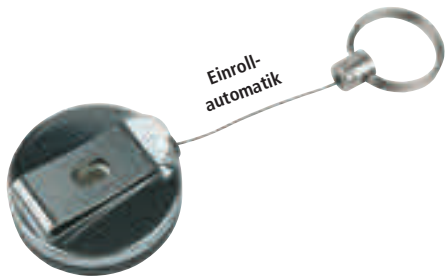

Schlüsselschnur, 2er Set
key cord, 2 pcs. set
llavero enrollable
porte-clés avec cable à enroulement



Schnur 65 cm lang, Befestigung mit Klammer am Gürtel, starke Rückzugfeder
 65 cm long cord, to fix at waistbelt, strong pull-back spring
 65 cm longitud del cable para fijar en una hebilla cable enrollable automático con muelle
 longueur 65 cm, à fixer à la ceinture- Enroulage automatique

| | ☐ cm | ↑ cm |
|---------|------|------|
| 93170 1 | Ø 4 | 2 |



Wein-Vakuum-Pumpe
vacuum wine pump
bomba de vacío para vino
pompe à vide pour le vin



inkl. 2 Stopfen, um offene Flaschen erneut zu versiegeln und den Wein zu konservieren
 incl. 2 stoppers, to reseal open wine bottles and conserve the wine
 incluye 2 tapones para cerrar perfectamente las botellas abiertas y conservar el vino
 livrée avec 2 bouchons pour refermer les bouteilles tout en conservant le vin parfaitement

| | ☐ cm | ↑ cm |
|---------|-------|------|
| 93123 7 | Ø 3,5 | 15 |

Einzelteile / spare parts / piezas sueltas / pièces détachées

Weinpumpe-Ersatzstopfen, 2er Set / wine pump stopper, 2 pcs. set
 tapones al vacío para el vino / set de 2 bouchons à vide pour le vin

| | | | |
|---------|-----|-----|--------|
| 93162 6 | Ø 3 | 4,5 | 2 pcs. |
|---------|-----|-----|--------|



Weinpumpe-Ersatzstopfen, 2er Set
wine pump stopper, 2 pcs. set
tapones al vacío para el vino
set de 2 bouchons à vide pour le vin



| | ☐ cm | ↑ cm | pcs. |
|---------|------|------|------|
| 93162 6 | Ø 3 | 4,5 | 2 ● |



Staubkappen, 2er Set
dust & fly cap, 2 pcs. set
tapón
bouchon anti-poussières et anti-insectes



schützt vor Staub und Insekten
 protects for dust and insects
 para proteger de la suciedad e insectos
 pour protéger de la poussière et des insectes

| | ☐ cm | ↑ cm | pcs. |
|---------|------|------|------|
| 93161 9 | Ø 4 | 8 | 2 ● |



Reinigungsbürste für Ausgießer
pourer cleaning brush
cepillo de limpieza para picos vertedores
brosse lave-bouchons doseurs



| | → cm |
|---------|------|
| 93102 2 | 16,5 |

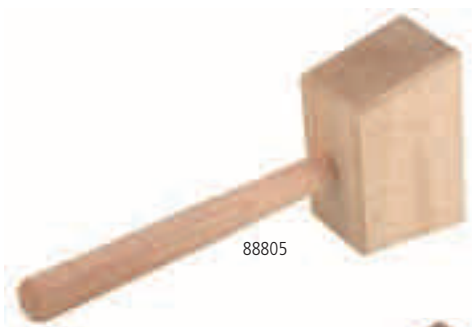

Holz-Hammer
hammer wood
martillo de madera
marteau en bois

HOLZ
WOOD

unlackiert
non lacquered
sin lacar
naturel, sans laque

| | cm | → cm |
|---------|----------|------|
| 88805 0 | 16 x 7,5 | 37,5 |
| 88806 7 | 12 x 5,5 | 29,5 |



mit Griffmulde

und Hängeloch

88806



Holz-Zapfhahn
tap, wood
grifo de madera
robinet bois

HOLZ
WOOD

Esche, mit Holzküken, mit Sicherheits-Faß-Anstich-System
ash, with special safe tapping-system
roble, con sistema especial para barricas
chêne, système spécial pour barriques

| | cm | → cm |
|---------|------------|------|
| 88803 6 | 10,5 x 3,5 | 18,5 |



Fassbock
timber trestle
banqueta de madera
petit banc en bois

HOLZ
WOOD

Fichte hell
spruce, light
abeto claro
sapin clair

| | cm | ↑ cm |
|---------|---------|------|
| 88802 9 | 35 x 35 | 27 |



Messing-Zapfhahn Partyfass
tap, brass
tapón de latón
bouchon en laiton

MESSING
BRASS



Zapfmeister mit Arretierautomatik und Entlüftungsventil
with special automatic arrest, with air bleed valve
cierre automático y válvula de aire
avec arrêt automatique et valve de ventilation

| | cm | → cm |
|---------|----------|-------|
| 88804 3 | 10,5 x 3 | 22 cm |



designed by **CULTURE FORM**



Dressing-Station

**Flaschen Display „SMALL“
bottle display / serving stand
exhibitor
présentoir**

für 4 Flaschen, Edelstahl mattiert
for 4 bottles, stainless steel satin polished finish
for 4 botelas, satinado
pour 4 bouteilles, inox mat satiné



| | | |
|---------|---------|------|
| | ☐ cm | ↑ cm |
| 40400 7 | 42 x 15 | 19,5 |

designed by **CULTURE FORM**



Wein-Präsentation

**Flaschen Display „LARGE“
bottle display / serving stand
exhibitor
présentoir**

für 4 Flaschen, Edelstahl mattiert
for 4 bottles, stainless steel satin polished finish
for 4 botelas, satinado
pour 4 bouteilles, inox mat satiné



| | | |
|---------|---------|------|
| | ☐ cm | ↑ cm |
| 40401 4 | 46 x 15 | 19,5 |



**Weinflaschenhalter
winebottle-stand
soporte para botellas de vino
porte-bouteille**



| | | |
|---------|--------|------|
| | ☐ cm | ↑ cm |
| 30333 1 | 22 x 6 | 20,5 |



**Weinflaschenhalter
winebottle-stand
soporte botella vino
porte-bouteille**



| | | |
|---------|------|------|
| | ☐ cm | ↑ cm |
| 30330 0 | Ø 25 | 25 |



**Gläserhalter / Tellerclips, 25er Set
glass plate clips, 25 pcs. set
25 pinzas sujetas copas
25 clips porte-verre**



zum Feststecken von Sekt- oder Weingläsern am Tellerrand, ideal für Empfänge, passend für alle gängigen Tellertypen und -größen, Größe innen Ø 3 cm
to clip on a plate and hold a glass, ideal for partys, useable for all current plates, size inside Ø 3 cm
pinzas de plato para sujetar la copa ideal para fiestas, válido para cualquier plato corriente. Plástico blanco. Medida interior Ø 3 cm
pince porte-verre à pied, à fixer sur le bord d'une assiette. Idéale pour réceptions, s'adapte sur tous types d'assiettes. Plastique blanc, Ø int. 3 cm

| | | |
|---------|------|------|
| | → cm | pcs. |
| 00111 4 | 8 | 25 |



**Drehascher „KLASSIKER“
ashtray „CLASSIC“
cenicero „CLASSIC“
cendrier giratoire**



Deckel mit Drehmechanismus
with rotary button
con botón giratorio
tourne par pression sur le bouton

| | cm | cm | |
|---------|----|------|--|
| | ∅ | ↑ | |
| 00054 4 | 13 | 10,5 | |



**Drehascher „KLASSIKER“
ashtray „CLASSIC“
cenicero „CLASSIC“
cendrier**



Deckel mit Drehmechanismus
with rotary button
con botón giratorio
tourne par pression sur le bouton

| | cm | cm | |
|---------|------|----|--|
| | ∅ | ↑ | |
| 00056 8 | 10,5 | 11 | |



**Wind-Aschenbecher „XL“
ashtray
cenicero
cendrier**



| | cm | cm | |
|---------|------|-----|---|
| | ∅ | ↑ | |
| 84212 0 | 14,5 | 4,5 | ○ |
| 84213 7 | 14,5 | 4,5 | ● |



83488

**Wind-Aschenbecher „CASUAL“
ashtray
cenicero
cendrier**



| | cm | cm | |
|---------|------|----|---|
| | ∅ | ↑ | |
| 83488 0 | 11,5 | 5 | ○ |
| 83489 7 | 11,5 | 5 | ● |



83610

83613

**Wind-Aschenbecher „CASUAL“
ashtray
cenicero
cendrier**



| | cm | cm | |
|---------|----|-----|---|
| | ∅ | ↑ | |
| 83610 5 | 10 | 4 | ○ |
| 83612 9 | 12 | 4,5 | ○ |
| 83611 2 | 10 | 4 | ● |
| 83613 6 | 12 | 4,5 | ● |



Aschenbecher
ashtray
cenicero
cendrier



Deckel hochglanzpoliert, Behälter matt poliert, mit Windschutzdeckel
lid mirror polished finish, container satin polished finish, with windcover
con tapa antiviento pulida brillante y contenedor pulido efecto satinado
couvercle anti-vent brillant, corps poli mat satiné

| | cm | cm |
|---------|------|-----|
| 00052 0 | Ø 12 | 5,5 |



stapelbar

Aschenbecher
ashtray
ceniceros
cendrier



matt poliert, mit Windschutzdeckel
satin polished finish, with windcover
acabado pulido satinado apilable, tapa para el viento
poli mat, empilable, couvercle anti-vent

| | cm | cm |
|---------|------|-----|
| 00090 2 | Ø 10 | 4,5 |
| 00091 9 | Ø 12 | 4,5 |



stapelbar

83616

Aschenbecher „CASUAL“
ashtray
cenicero
cendrier



| | cm | cm | |
|---------|-------|-----|---|
| 83614 3 | Ø 9,5 | 4,5 | ○ |
| 83616 7 | Ø 9,5 | 4,5 | ● |



matt poliert



Aschenbecher
ashtray
cenicero
cendrier



| | cm | cm |
|---------|------|-----|
| 00043 8 | Ø 14 | 2,5 |
| 00044 5 | Ø 16 | 2,5 |



stapelbar



Aschenbecher
ashtray
cenicero
cendrier



matt poliert, hochwertige schwere Ausführung
satin polished finish, high quality, heavy gauge
pulido satinado, alta calidad, apilable.
poli mat, empilable, belle qualité

| | cm | cm |
|---------|------|----|
| 00048 3 | Ø 8 | 3 |
| 00050 6 | Ø 10 | 3 |
| 00049 0 | Ø 12 | 3 |

**HOT
PRICE**



Aschenbecher „CASUAL“, 3er Set
ashtray, 3 pcs. set
set de cenicero 3 piezas
pack de 3 mini cendriers



| | cm | cm | pcs. |
|---------|-----|----|------|
| 00576 1 | ∅ 8 | 3 | 3 |

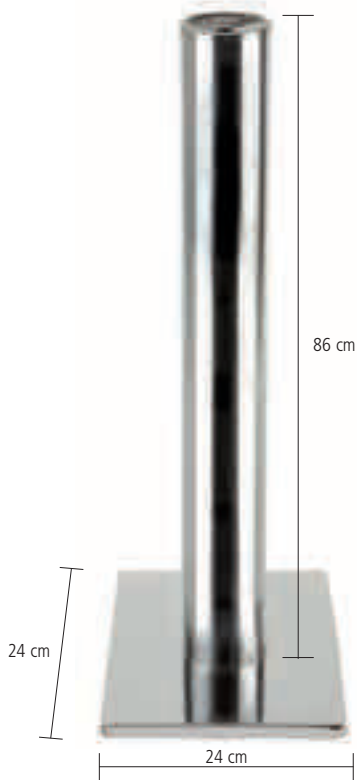

Standascher / Abfalleimer „SMOKERS POINT“
floor standing ashtray
cenicero de pie
cendrier sur pied



glanz poliert, mit herausnehmbaren Aschereinsatz
mirror polished finish, with ashtray insert and with litter bin
pulido acabado con cenicero y papelera
poli brillant inséré, extractible pour vidage facile

| | cm | cm | ltr. |
|---------|---------------|----|------|
| 00579 2 | ∅ 9 / 24 x 24 | 86 | 3 |



Standascher „DIABOLO“
standing ashtray
cenicero de pie
cendrier sur pied



für den Innen- und Außenbereich, inkl. 1,5 kg Sand, eine Ascheschale für die Sandbefüllung und ein Metallsieb

for in,- outdoor use, included a bag of sand and a metal sieve
uso en interior o exterior, incluye una bolsa de arena y embudo de metal
usage en intérieur ou extérieur, livré avec un sac de sable et entonnoir métal

| | cm | cm |
|---------|------|----|
| 00574 7 | ∅ 40 | 60 |

vielseitig nutzbar!



zerlegbar und stapelbar!

EDELSTAHL
STAINLESS
INOX

Standascher / Abfalleimer
litter bin / ashtray
papelera con cenicero superior
poubelle avec cendrier supérieur

mit herausnehmbaren Aschereinsatz und herausnehmbaren verzinkten Innenbehälter / Eimer
with ashtray insert and litter bin
con cenicero y papelera metálica
cendrier et corbeille à détritrus



| | ☐ cm | ↑ cm |
|---------|------|------|
| 00575 4 | Ø 30 | 60 |

**HOT
PRICE**



Tret-Beutelhalter
pedal bin
coletor a pedal
poubelle à pédale

geeignet für Müllbeutel bis 120 ltr., 110 x 70 cm
suitable for bags up to 120 ltr., 110 x 70 cm
apto para bolsas hasta 120 l. Medidas sin bolsa 110 x 70 cm
apte pour sacs de 120 l., dim. Sans sac 110 x 70 cm

 EDELSTAHL
STAINLESS
INOX

| | ☐ cm | ↑ cm |
|---------|---------|------|
| 00580 8 | 59 x 43 | 96 |



easy handling,
step on bin

2 Lenkrollen mit Feststellern
2 wheels with brakes



10 Schilderhalter „FLEX CLIP“
10 sign holders
pack de 10 clips
pack de 10 porte-étiquettes



Durch die bewegliche Verbindung der Klemme und Schilderhalterung ein extrem flexibler Cliphalter!

multi angle ticket clip
 inclinable con pinza
 inclinable avec pince
 → cm

| | | | |
|-------|---|------|-------------|
| 71472 | 4 | 9,5 | ○ elfenbein |
| 71473 | 1 | 12,5 | ○ elfenbein |
| 71474 | 8 | 9,5 | ● |
| 71475 | 5 | 12,5 | ● |

Zubehör / spare parts / recambios / pièces de rechange

passende Schilder, 10er Set / fitting signs, 10 pcs. set
 set de 10 cartelitos / set de 10 étiquettes

| | □ cm | pcs. |
|-------|-------------|------|
| 11879 | 9 7,7 x 5,2 | 10 |
| 12879 | 8 5,0 x 3,0 | 10 |

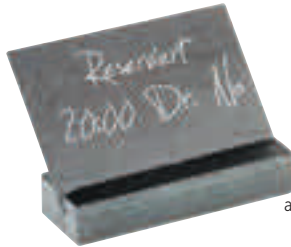

mit Kreide und
 abwaschbarem Stift
 beschriftbar

Tafelhalter / Schild
slate sign
caballete de mesa, pizarra
plaque signalétique avec support



| | □ cm | ↑ cm |
|-------|----------|------|
| 00060 | 5 12 x 4 | 7 |



2 Tischaufsteller
2 table stand
2 caballete de mesa
2 chevalet de table



| | □ cm | ↑ cm | pcs. |
|-------|-----------|------|------|
| 00017 | 9 5,5 x 5 | 3,5 | 2 |
| 00013 | 1 5,5 x 5 | 3,5 | 2 |
| 00572 | 3 5,5 x 5 | 3,5 | 2 |
| 00573 | 0 5,5 x 5 | 3,5 | 2 |

Tischnummernschild
table numbers
números para mesa
numéros de table



matt poliert, Zahlen aus schwarzem Siebdruck, Materialstärke 0,8 mm, schwere Qualität, VE: 12 aufeinanderfolgende Zahlen, nicht einzeln lieferbar

satin polished finish, numbers black screenprint, material 0,8 mm thick, heavy gauge, unit: set of 12 numbers only

pulido satinado, números serigrافيados en negro, grosor del acero 0,8 mm serigrafía no apta para lavavajillas, set 12 números seguidos

mat satiné, numéros sérigraphés en noir (non-résistants au lave-vaisselle), épaisseur 0,8 mm, 12 numéros consécutifs

| | □ cm | pcs. |
|-------|-------------|----------|
| 71450 | 2 5,3 x 4,5 | 1-12 12 |
| 71451 | 9 5,3 x 4,5 | 13-24 12 |
| 71452 | 6 5,3 x 4,5 | 25-36 12 |
| 71453 | 3 5,3 x 4,5 | 37-48 12 |
| 71454 | 0 5,3 x 4,5 | 49-60 12 |
| 71455 | 7 5,3 x 4,5 | 61-72 12 |

NEW

**Kartenhalter, 2er Set
table stand, 2 pcs. set
set de dos piezas, soporte de mesa
set de 2 pièces, support de table**

HOLZ
WOOD



inklusive 40 weißen Beschriftungskarten
incl. 40 cards
incluye 40 tarjetas
includ 40 étiquettes

| | cm | cm | |
|---------|---------|-----|---------------|
| 00038 4 | 9 x 3,5 | 6,5 | ○ |
| 00039 1 | 9 x 3,5 | 6,5 | ● braun/brown |



**10 Beschriftungsclips, inkl. 10 Schilder
10 sign holders, with 10 signs
10 soportes + 10 cartelitos
10 supports + 10 étiquettes**



| | cm | pcs. | |
|---------|---------|------|---|
| 71482 3 | 6 x 2,7 | 10 | ○ |
| 71483 0 | 6 x 2,7 | 10 | ● |



Einzelteile / spare parts / piezas sueltas / pièces détachées

passende Schilder, 10er Set / fitting signs, 10 pcs. set
set de 10 cartelitos / set de 10 étiquettes

| | | |
|---------|-----------|----|
| 11879 9 | 7,7 x 5,2 | 10 |
|---------|-----------|----|

**Schilderhalter „FLEXIBEL“
sign holder
soporte para cartelito
support pour menu de table**



in 2 Längen
erhältlich



biegsamer Draht mit zwei Klemmen, extrem flexibel, die Klemmen lassen sich weit öffnen
bedable metal coil adds visual interest, two metal clip open
metal cromado flexible, 2 pinzas con gran apertura
métal chromé, flexible, 2 pinces à grande ouverture

| | → cm | |
|---------|------|--|
| 71470 0 | 12 | ohne Schilder / without signs sin cartelitos / sans étiquette |
| 71471 7 | 23 | ohne Schilder / without signs sin cartelitos / sans étiquette |
| 71480 9 | 12 | inkl. 10 Schilder 11879 / incl. 10 signs 11879 con 10 cartelitos 11879 / avec 10 étiquettes 11879 |
| 71481 6 | 23 | inkl. 10 Schilder 11879 / incl. 10 signs 11879 con 10 cartelitos 11879 / avec 10 étiquettes 11879 |

Einzelteile / spare parts / piezas sueltas / pièces détachées

passende Schilder, 10er Set
fitting signs, 10 pcs. set
set de 10 cartelitos
set de 10 étiquettes

| | cm | pcs. |
|---------|-----------|------|
| 11879 9 | 7,7 x 5,2 | 10 |
| 12879 8 | 5,0 x 3,0 | 10 |



Kartenhalter „WAVE“, 4er Set
table stands „WAVE“, 4 pcs. set
soporte de mesa „WAVE“, 4 piezas
set de 4 „WAVE“ porte-étiquette



inkl. 20 weiße Beschriftungskarten (8,5 x 5,5 cm)
 incl. 20 white lables (8,5 x 5,5 cm)
 incluye 20 etiquetas blancas (8,5 x 5,5 cm)
 20 étiquettes blanches incluses (8,5 x 5,5 cm)

| | cm | ↑ cm | pcs. |
|---------|-----------|------|------|
| 00034 6 | 9,5 x 2,5 | 2 | 4 |



Kartenhalter „WÜRFEL“, 4er Set
table stands „DICE“, 4 pcs. set
soporte de mesa „DADOS“, 4 piezas
set de 4 „dés“ porte-étiquette



inkl. 20 weiße Beschriftungskarten, mehrfach beschriftbar
 incl. 20 white lables
 incluye 20 etiquetas blancas
 20 étiquettes blanches incluses

| | cm | pcs. |
|---------|-----------|------|
| 00078 0 | 3 x 3 x 3 | 4 |



Kartenhalter „ZYLINDER“, 4er Set
table stands „CYLINDER“, 4 pcs. set
soporte de mesa „CILINDRO“, 4 piezas
set de 4 „cylindres“ porte-étiquette



inkl. 20 weiße Beschriftungskarten, mehrfach beschriftbar
 incl. 20 white lables
 incluye 20 etiquetas blancas
 20 étiquettes blanches incluses

| | cm | pcs. |
|---------|-------------|------|
| 00079 7 | 3 x 3 x 2,8 | 4 |



6 Stck. Halter
 12 Stck. Karten

Kartenhalter-Set
card holder set
set de porta cartelitos
pack complet supports + étiquettes



18-teilig: 6 Kartenhalter 4 x 2,5 cm + 12 Kunststoff-Beschriftungskarten 10 x 5,7 cm
 18 pcs. set: 6 card holder 4 x 2,5 cm + 12 plastic cards of inscription 10 x 5,7 cm
 set de 18 piezas: 6 soportes cromados 4 x 2,5 cm, 12 carteles para inscripción, 10 x 5,7 cm
 set de 18 pièces: 6 supports chromés 4 x 2,5 cm +, 12 panneaux 10 x 5,7 cm

| | cm |
|---------|---------|
| 00022 3 | 4 x 2,5 |



Beschriftungskarten, 10er Set
card holder, 10 pcs. set
set de porta cartelitos, 10 piezas
pack complet supports + 10 pièces



| | cm | strength |
|---------|---------|----------|
| 00037 7 | 7,5 x 5 | 0,4 mm ● |

designed by **KIRCHHOFF & EUWENS**



Tischkartenhalter „PROFI“
table stands
soporte-carta para la mesa
support pour menu de table



| | ▣ cm | ↑ cm |
|---------|-----------|------|
| 40425 0 | 9,5 x 7,5 | 13,5 |

designed by **KIRCHHOFF & EUWENS**



für DIN A4
und DIN A5
Karten



Tischkartenhalter
table stands
soportes de mesa
supports de table



| | ▣ cm | ↑ cm |
|---------|----------|------|
| 00071 1 | 14 x 5,5 | 14 |



00362

00363

Speisekartenhüllen, 3er Set
menu cover, 3 pcs. set
funda para carta, set 3 piezas
protège-menu transparent, le pack de 3



einseitig offen, glasklarer Kunststoff
open at one side, clear plastic
apertura por un lado, plástico transparente
ouverture sur un côté, plastique transparent

| | ▣ cm |
|---------|-------------|
| 00362 0 | 16,5 x 11,5 |
| 00363 7 | 20 x 12 |



00036

00030

Tischkartenhalter
table stand
soporte-carta para la mesa
support pour menu de table



matt poliert
satin polished finish
pulido satinado
poli mat satiné

| | ▣ cm | ↑ cm |
|---------|-----------|------|
| 00030 8 | 8 x 7 | 2 |
| 00036 0 | 6,1 x 4,5 | 4 |



Kartenhalter, 2er Set
menu holder, 2 pcs. set
porta cartas de mesa set 2 piezas
pack de 2 supports pour menu de table

HOLZ
WOOD

| | □ cm | ↑ cm | pcs. |
|---------|---------|-----------|------|
| 00023 0 | 8,5 x 6 | 4,5 / 8,5 | 2 |



Kartenhalter, 2er Set
menu holder, 2 pcs. set
porta cartas de mesa set 2 piezas
pack de 2 porte-menus de table



matt poliert
 satin polished finish
 pulido acabado en mate
 mate

| | □ cm | ↑ cm | pcs. |
|---------|---------|---------|------|
| 00021 6 | 8,5 x 4 | 4 / 8,5 | 2 |



3 Höhen

Bankettkartenständer
menu stand / table number
porta-etiqueta o carta de sobremesa con pinza
porte-étiquette de table avec pince, porte-menu, ou n° de tabletc



hochglanzpoliert, schwere Qualität
 mirror polished finish, heavy gauge
 acero inoxidable de alta calidad
 inox, belle qualité

| | □ cm | ↑ cm |
|---------|-------|------|
| 71460 1 | Ø 7,5 | 18,5 |
| 71461 8 | Ø 7,5 | 29 |
| 71462 5 | Ø 7,5 | 46 |



00074

Kartenhalter, 4er Set
table stands, 4 pcs. set
set 4 piezas soportes de mesa
set de 4 pinces „cubes“



inkl. 20 weiße Beschriftungskarten
 incl. 20 white labels
 incluye 20 etiquetas blancas
 20 étiquettes blanches incluses

| | □ cm | ↑ cm | pcs. |
|---------|-----------|------|------|
| 00074 2 | 3 x 3 | 12 | 4 |
| 00700 0 | 2,5 x 2,5 | 12 | 4 |



Kartenhalter, 2er Set
table stand, 2 pcs. set
set de 2 piezas, soporte de mesa
set de 2 pièces, support de table

ACRYL
ACRYLIC

inkl. 40 Beschriftungskarten, durch Magnete einfach zusammenklappbar
 incl. 40 cards, easily foldable with magnets
 incluye 40 tarjetas, fácil de plegar, con imanes
 inclut 40 étiquettes, fácil à plier, avec aimants

| | cm | pcs. |
|---------|-------------|------|
| 00076 6 | 9 x 3 x 5,5 | 2 |



Tischkartenhalter, 4er Set
table stands, 4 pcs. set
set de 4 pinzas porta-etiquetas inox
pack de 4 porte-étiquettes à pince, inox

EDELSTAHL
STAINLESS
INOX



hochglanzpoliert, schwerer Fuß, inkl. 20 weiße Beschriftungskarten
 mirror polished finish, heavy food, incl. 20 white labels
 acabado brillante, incluye 20 etiquetas en blanco
 poli brillant, inclut 20 étiquettes blanches

| | cm | cm | pcs. |
|---------|-----|----|------|
| 00070 4 | Ø 4 | 10 | 4 |



Buffet-Schilder, 3er Set
buffet signs, 3 pcs. set
set de 3 piezas indicadores buffet
set de 3 petits chevalets de buffet

EDELSTAHL
STAINLESS
INOX



können mit einem wasserfesten Filzschreiber beschrieben werden
 can be marked with water-based felt markers
 pueden marcarse con rotuladores de agua
 écriture facile avec un feutre lavable à l'eau

| | cm | cm | pcs. |
|---------|----------|-----|------|
| 03610 9 | 12 x 6 | 6 | 3 |
| 03611 6 | 16 x 8,5 | 8,5 | 3 |



Beschriftungsfähnchen-Set
signs set
indicadores de porcelana
étiquettes en porcelaine

PORZELLAN
PORCELAIN



7-teilig: 6 Fähnchen + 1 Filzschreiber schwarz, Beschriftung lässt sich leicht entfernen
 7 pcs. set: 6 bannerets + 1 water-based felt marker, the marking can easily removed
 set de 7 piezas: 6 banderitas de porcelana, 1 rotulador lavable con agua, el marcador se puede eliminar fácilmente
 set de 7 pièces: 6 étiquettes „drapeau“ en porcelaine + 1 feutre lavable à l'eau

| | cm |
|---------|---------|
| 00077 3 | 5,5 x 8 |

NEW

63 cm



30 cm

**Aufsteller „ACHTUNG RUTSCHGEFAHR“
stand „WET FLOOR“
stand**

PP
POLYPROPYLEN

| | □ cm | ↑ cm |
|---------|---------|------|
| 71421 2 | 30 x 63 | 63 |

klappbar / folding

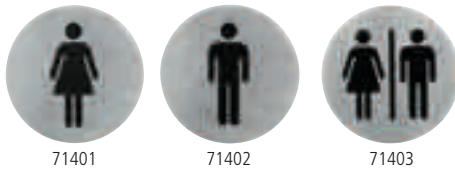

71401

71402

71403



71404

71405

71406



71407

71408

71409

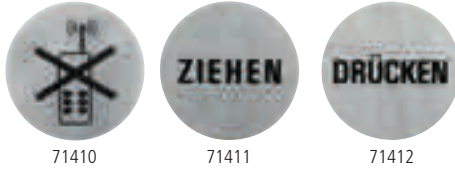

71410

71411

71412



71413

71414

71415



71416



71418



71419

**Türsymbol
sign plate
pictogramas
pictogrammes**

EDELSTAHL
STAINLESS
INOX

matt poliert, Materialstärke 1 mm, schwarzer Siebdruck, Rückseite selbstklebend
satin polished finish, back side auto-adhesive

acabado satinado, grosor 1 mm, serigrafía negra, reverso adhesivo
mat satiné, épaisseur 1 mm, sérigraphie couleur noire, dos adhésif

| | □ cm | |
|---------|-------|--|
| 71401 4 | Ø 7,5 | Damen / ladies / damas / dames |
| 71402 1 | Ø 7,5 | Herren / gents / caballeros / messieurs |
| 71403 8 | Ø 7,5 | Damen und Herren / ladies and gents damas y caballeros / dames et messieurs |
| 71404 5 | Ø 7,5 | Rollstuhl / disabled / discapacitados / handicapés |
| 71405 2 | Ø 7,5 | WC |
| 71406 9 | Ø 7,5 | Rauchen / smoking / fumadores / fumeurs |
| 71407 6 | Ø 7,5 | Nicht rauchen / no smoking no fumadores / non-fumeurs |
| 71408 3 | Ø 7,5 | Bitte hinsetzen / please sit por favor siéntese / asseyez-vous SVP |
| 71409 0 | Ø 7,5 | Garderobe / coats / guardarropa / vestiaire |
| 71410 6 | Ø 7,5 | Handy verboten / no mobiles apague el móvil / portables éteints |
| 71411 3 | Ø 7,5 | „ZIEHEN“ |
| 71412 0 | Ø 7,5 | „DRÜCKEN“ |
| 71413 7 | Ø 7,5 | „PULL“ |
| 71414 4 | Ø 7,5 | „PUSH“ |
| 71415 1 | Ø 7,5 | „KEIN ZUTRITT“ |
| 71416 8 | Ø 7,5 | „NO ENTRY“ |
| 71418 2 | Ø 16 | Rauchen / smoking / fumadores / fumeurs |
| 71419 9 | Ø 16 | Nicht rauchen / no smoking no fumadores / non-fumeurs |



2-teilig

**Vase
flower vase
florero
soliflor**

inkl. Halterung, Blume fixiert sich durch die Halterung mittig in der Vase
incl. holder, the holder fixes a flower in the middle of the vase
incluido fijación que mantiene la flor en el centro del jarrón
y compris fixation pour centrer la fleur

| | ☐ cm | ↑ cm | 📦 kg |
|---------|------|------|------|
| 04019 9 | Ø 5 | 13 | 0,29 |



**Vase
flower vase
florero
vase soliflor**

hochglanzpoliert, schwerer Fuß, möbelschonende Unterseite
mirror polished finish, heavy quality
pulido brillante alta calidad
brillant, bonne qualité

| | ☐ cm | ↑ cm | 📦 kg |
|---------|------|------|------|
| 04018 2 | Ø 6 | 19 | 0,23 |



**Vase
flower vase
florero
vase soliflor**

Edelstahl-Look, Zinkdruckguss, vernickelt, lackiert, anlaufgeschützt, schwere Ausführung
stainless steel look, heavy zink alloy, nickel plated, laquered
aspecto acero, acabado satinado
aspect inox, fini mat satiné

| | ☐ cm | ↑ cm | 📦 kg |
|---------|-------|------|------|
| 04015 1 | Ø 4 | 16,5 | 0,17 |
| 04016 8 | Ø 4,5 | 20 | 0,20 |



**Vase
flower vase
florero
vase soliflor**

Edelstahl-Look, Zinkdruckguss, vernickelt, lackiert, anlaufgeschützt, schwere Ausführung
stainless steel look, heavy zink alloy, nickel plated, laquered
aspecto acero, acabado satinado
aspect inox, fini mat satiné

| | ☐ cm | ↑ cm | 📦 kg |
|---------|-------|------|------|
| 04017 5 | Ø 6,5 | 18 | 0,36 |





Kerzenleuchter, 2er Set
candle sticks, 2 pcs. set
candelabro , set de 2 piezas
set de 2 chandeliers

METALL
VERSILBERT

ohne Kerzen
 without candles
 sin velas
 livré sans bougies

| | ☐ cm | ↑ cm | pcs. |
|---------|------|------|------|
| 04007 6 | Ø 6 | 13 | 2 |
| 04008 3 | Ø 6 | 7 | 2 |



Kerzenleuchter „CLASSIC“, 2er Set
candle sticks, 2 pcs. set
candelabros, set de 2 piezas
set de 2 chandeliers

METALL
VERSILBERT

ohne Kerzen
 without candles
 sin velas
 livré sans bougies

| | ☐ cm | ↑ cm | pcs. |
|---------|------|------|------|
| 04035 9 | Ø 10 | 20,5 | 2 |



Kerzenleuchter „CLASSIC“
candle sticks
candelabro
chandelier

METALL
VERSILBERT

3-flammig, ohne Kerzen
 3-lid, without candles
 3 ramas, se sirve sin velas
 3 branches, livré sans bougies

| | ☐ cm | ↑ cm |
|---------|---------|------|
| 04036 6 | 22 x 10 | 22,5 |



Kerzenleuchter „CLASSIC“
candle sticks
candelabros
chandelier

METALL
VERSILBERT

5-flammig, ohne Kerzen
 5-lids, without candles
 para 5 velas, se sirve sin velas
 5 branches, livré sans les bougies

| | ☐ cm | ↑ cm |
|---------|---------|------|
| 04037 3 | 22 x 22 | 24 |



**Kerzenleuchter
candleholder
candelabro
chandelier**



04001

hochwertige Gastro Ausführung, ohne Kerzen
heavy quality, without candles
alta calidad (se entrega sin velas)
haute qualité (livraison sans bougies)

| | ☐ cm | ↑ cm | |
|---------|-------------|------|--|
| 04001 4 | 27,5 x 27,5 | 25 | 5-flammig / 5 lid / 5 ramas / 5 branches |
| 04002 1 | 27,5 x 11 | 25 | 3-flammig / 3 lid / 3 ramas / 3 branches |
| 04003 8 | Ø 11 | 22 | 1-flammig / 1 lid / 1 rama / 1 branche |
| 04004 5 | Ø 11 | 10 | 1-flammig / 1 lid / 1 rama / 1 branche |



04002



04003



04004



**Kerzenleuchter „XL“
candleholder
candelabro
grand chandelier**



04005

extra hoch und schwer, ohne Kerzen
extra high and heavy
pesado y de alta calidad
lourd et de haute qualité

| | ☐ cm | ↑ cm | |
|---------|---------|------|--|
| 04005 2 | 35 x 13 | 39 | 3-flammig / 3 lid / 3 ramas / 3 branches |
| 04006 9 | 35 x 35 | 39 | 5-flammig / 5 lid / 5 ramas / 5 branches |



04006



Höhe 39 cm

NEW



**Kerzenleuchter
candleholder
candelabro
chandelier**



extra schwerer Fuß, Kupfer-look
heavy foot, copper look
pie pesado, cobre en color
pied lourd, couleur cuivre

| | ☐ cm | ↑ cm | |
|---------|------|------|----------|
| 04024 3 | Ø 10 | 11 | ● copper |
| 04025 0 | Ø 10 | 16 | ● copper |
| 04026 7 | Ø 10 | 22 | ● copper |



**Kerzenleuchter
candleholder
candelabro
chandelier**



extra schwerer Fuß, verchromt
heavy foot, chrome plated
pie pesado, asa comada
pied lourd, chromé

| | ☐ cm | ↑ cm | |
|---------|------|------|----------|
| 04020 5 | Ø 10 | 11 | ● chrome |
| 04021 2 | Ø 10 | 16 | ● chrome |
| 04022 9 | Ø 10 | 22 | ● chrome |

**Kerzenleuchter „XXL“
candleholder
candelabro
chandelier**



5-flammig, Zinkdruckguss, vernickelt, schwere Ausführung, einfache Montage, ohne Kerzen
5 branches, zinc alloy nickel-plated, heavy model, easy to assemble
5 ramas, fundición de aleación de zinc niquelada, alta calidad y fácil montaje
5 branches, fonte d'alliage de zinc nickelée, haute qualité, facile à monter

| | ☐ cm | ↑ cm |
|---------|---------|------|
| 04000 7 | 46 x 46 | 56 |
| 04012 0 | 46 x 46 | 78 |
| 04013 7 | 46 x 46 | 98 |



3 Höhen:
56 cm
78 cm
98 cm

EAN = 40 04 133 XXXXX X



Windlicht „BALL“
wind light
porta vela
lampe à bougie

GLAS
GLASS

EDELSTAHL
STAINLESS
INOX

Edelstahl poliert, Glas satiniert, schwere standsichere Ausführung
 mirror polished finish, heavy quality
 acabado efecto espejo, alta calidad, base pesada
 poli brillant, belle qualité, pied pesant

| | ☐ cm | ↑ cm |
|---------|------|------|
| 03033 6 | Ø 12 | 11,5 |



03013

03014

Edelstahlfuß wird nicht heiß!
 Keine Verbrennungsgefahr!

Windlicht / Tischleuchte
wind light
porta velas
porte-bougie de table, anti-vent

GLAS
GLASS

METALL
VERCHROMT

| | ☐ cm | ↑ cm |
|---------|------|------|
| 03013 8 | Ø 11 | 22 |
| 03014 5 | Ø 11 | 32 |

Einzelteile / spare parts / piezas sueltas / pièces détachées

Ersatzglas / spare glass / vidrio de recambio solo / verre de rechange transparent, seul

| |
|---------|
| 03015 2 |
|---------|



Edelstahlfuß wird nicht heiß!
 Keine Verbrennungsgefahr!

Windlichter, 2er Set
wind lights, 2 pcs. set
set de 2 piezas porta velas
set de 2 porte-bougies anti-vent

GLAS
GLASS

EDELSTAHL
STAINLESS
INOX

hochglanzpoliert, Gläser klar, mit möbelschonender Filzunterseite
 mirror polished finish, glasses clear, non-scratching undersurface
 acabado pulido brillante, vidrio transparente, pie revestido antiralladuras incluye 2 velas.
 brillant, verre transparent, pied revêtu pour ne pas rayer le mobilier. 2 bougies incluses

| | ☐ cm | ↑ cm | pcs. |
|---------|------|------|------|
| 03026 8 | Ø 5 | 8 | 2 |

Einzelteile / spare parts / piezas sueltas / pièces détachées

Ersatzglas / spare glass / vidrio de recambio solo / verre de rechange transparent, seul

| |
|---------|
| 03027 5 |
|---------|



03016
2er Set

Windlichter, 2er Set
wind lights, 2 pcs. set
set de 2 portavelas antiviento
pack de 2 porte-bougies anti-vent



2er Set, matt poliert, Gläser satiniert, Edelstahlfuß wird nicht heiß, keine Verbrennungsgefahr

2 pcs. set, satin polished finish, glasses satin

set de dos piezas, acabado pulido mate satinado, cristales satinados

inox mat satiné et verre mat

| | cm | cm | pcs. |
|---------|-------|------|------|
| 03016 9 | Ø 7,5 | 12,5 | 2 |



03017
1 Stck.

Ø 6 cm
Teelicht

(passend für
Teelicht Ø 6 cm)

matt poliert, Glas satiniert, Edelstahlfuß wird nicht heiß, keine Verbrennungsgefahr

satin polished finish, glass satin

acabado efecto satinado, cristal satinado

inox mat satiné et verre mat

| | | | |
|---------|-------|----|---|
| 03017 6 | Ø 9,5 | 15 | 1 |
|---------|-------|----|---|

Einzelteile / spare parts / piezas sueltas / pièces détachées

Ersatzglas / spare glass / cristal de recambio / verre de rechange

| | |
|---------|------------------------|
| 03028 2 | für / for / para 03016 |
| 03023 7 | für / for / para 03017 |



Edelstahlfuß wird nicht heiß!
Keine Verbrennungsgefahr!

Windlichter, 2er Set
wind lights, 2 pcs. set
set de 2 portavelas antiviento
pack de 2 porte-bougies anti-vent



matt poliert, Gläser satiniert, mit möbelschonender Filzunterseite

satin polished finish, glasses satin, non-scratching undersurface

pulido acabado efecto satinado, cristales satinados, incl. velas

inox mat satiné et verre mat, bougies incluses

| | cm | cm | pcs. |
|---------|-----|----|------|
| 03020 6 | Ø 5 | 15 | 2 |

Einzelteile / spare parts / piezas sueltas / pièces détachées

Ersatzglas / spare glass / cristal de recambio / verre de rechange

| | |
|---------|--|
| 03025 1 | |
|---------|--|



Edelstahlfuß wird nicht heiß!
Keine Verbrennungsgefahr!

Windlichter, 2er Set
wind lights, 2 pcs. set
portavelas antiviento, set de 2 piezas
verre de rechange transparent, seul



matt poliert, Gläser satiniert, mit möbelschonender Filzunterseite

satin polished finish, glasses satin, non-scratching undersurface

pulido acabado satinado, vidrio satinado, pie revestido antiralladuras, incluye velas

poli mat satiné, verre mat satiné, revêtement protecteur mobilier sous le pied, bougies incluses

| | cm | cm | pcs. |
|---------|-----|----|------|
| 03012 1 | Ø 8 | 22 | 2 |

**Teelichthalter, 2er Set
tealight candle sticks, 2 pcs. set
candelabro, set de 2 piezas
set de 2 porte-bougies**



mit möbelschonender Unterseite
non-scratching undersurface
base antirradaduras
revêtement protecteur mobilier sous le pied

| | ☐ cm | ↑ cm |
|---------|-------|------|
| 03010 7 | Ø 9,5 | 2,5 |



Abbildung Originalgröße

**Windlichter „LATERNE“, 2er Set
wind lights, 2 pcs. set
porta vela, set de dos piezas
lampe t mpete „LATERNE“, 2   Set**



Metall schwarz lackiert, Gl ser mattiert
metal black, glass satin
metal negro, cristal satinado, incl. velas
m tal noir, verre mate

| | ☐ cm | ↑ cm | pcs. |
|---------|-------|------|------|
| 03021 3 | 8 x 8 | 11,5 | 2 |



PROFI LINE



Profi-Material auf der Basis von Polypropylen, das optisch und haptisch einem Naturprodukt nahezu gleich ist. Matte Oberfläche, handgefertigt.

Wickerware made of synthetic fiber. Matt surface looks like real nature rattan, handmade.

Trensado a mano en fibra sintética de polipropileno, su acabado mate le da el aspecto de un producto natural. Un aspecto de ratán natural, hecho a mano.

Tressé main en fibre synthétique polypropilène, sa finition mate lui donne un aspect totalement naturel.





50210
Ø 37 cm

Korb, rund „PROFI LINE“
basket, round
cesta redonda
corbeille ronde



| | □ cm | ↑ cm |
|---------|------|------|
| 50210 9 | Ø 37 | 9 |
| 50215 4 | Ø 42 | 12 |



50215
Ø 42 cm

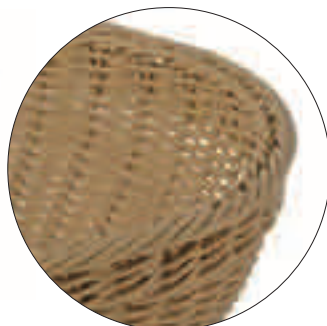

Korb, rund „PROFI LINE“
basket, round
cesta redonda
corbeille ronde



| | □ cm | ↑ cm |
|---------|-----------|--------|
| 50205 5 | Ø 31 / 37 | 12 / 6 |



50100

Korbschütte, rund „PROFI LINE“
basket, round
cesta redonda
corbeille ronde



mit Griffen
with handles
con asas
avec anses

| | □ cm | ↑ cm |
|---------|--------|------|
| 50100 3 | Ø 36,5 | 12,0 |
| 50105 8 | Ø 42,0 | 18,5 |
| 50110 2 | Ø 46,0 | 18,5 |



50110

50300



Systemkorb, gestäbt „PROFI LINE“
basket
cesta
corbeille



| | □ cm | ↑ cm |
|---------|---------|---------|
| 50300 7 | 30 x 40 | 27 / 16 |
| 50305 2 | 45 x 40 | 27 / 16 |
| 50310 6 | 60 x 40 | 27 / 16 |

50305



50310



Trenner „PROFI LINE“
divider
divisor
paroi de séparation



| | → cm | ↑ cm |
|---------|------|---------|
| 50315 1 | 38 | 26 / 15 |



Systemkorb „PROFI LINE“
basket
cesta
corbeille



| | □ cm | ↑ cm |
|---------|---------|---------|
| 50400 4 | 40 x 50 | 25 / 14 |



Brötchenschütte „PROFI LINE“
roll / bun basket
cesta para bollos
corbeille à petits pains



| | □ cm | ↑ cm |
|---------|---------|------|
| 50510 0 | 60 x 40 | 60 |



50500

Stangenbrotkorb „PROFI LINE“
 baguette basket
 cesta de baguette
 corbeille à baguettes



| | □ cm | ↑ cm | |
|---------|-----------|------|---|
| 50500 1 | Ø 28 / 30 | 38 | ● |
| 50501 8 | Ø 28 / 30 | 38 | ● |



50501

Bäcker-Maß-Größen



50910
60 x 20 cm

Tablett Bäcker-Maß „PROFI LINE“
 tray baker size
 bandeja tamaño pastelero
 plaque à pâtisserie dimensions „boul-pâte“



| | □ cm | ↑ cm |
|---------|---------|------|
| 50900 9 | 40 x 20 | 5 |
| 50905 4 | 40 x 30 | 5 |
| 50910 8 | 60 x 20 | 5 |
| 50915 3 | 60 x 40 | 5 |



50915
60 x 40 cm



Auslage Tablett flach, Bäcker-Maß
 „PROFI LINE“
 display tray flat, baker size
 bandeja de presentación, tamaño panaderia
 plateau de présentation, dimensions „boul-pâte“



| | □ cm | ↑ cm |
|---------|---------|------|
| 40296 6 | 40 x 30 | 1 |
| 40297 3 | 60 x 40 | 1 |



Korb, rund „PROFI LINE“
basket, round
cesta redonda
corbeille ronde



| | □ cm | ↑ cm | |
|---------|------|------|---|
| 50600 8 | Ø 16 | 8 | ● |
| 50605 3 | Ø 20 | 8 | ● |
| 50610 7 | Ø 29 | 7 | ● |
| 50601 5 | Ø 16 | 8 | ● |
| 50606 0 | Ø 20 | 8 | ● |
| 50611 4 | Ø 29 | 7 | ● |
| 50602 2 | Ø 16 | 8 | ● |
| 50607 7 | Ø 20 | 8 | ● |
| 50612 1 | Ø 29 | 7 | ● |



Korb, oval „PROFI LINE“
basket, oval
cesta oval
corbeille ovale



| | □ cm | ↑ cm | |
|---------|---------|------|---|
| 50800 2 | 25 x 19 | 6,5 | ● |
| 50815 6 | 32 x 23 | 7,0 | ● |
| 50801 9 | 25 x 19 | 6,5 | ● |
| 50816 3 | 32 x 23 | 7,0 | ● |
| 50802 6 | 25 x 19 | 6,5 | ● |
| 50817 0 | 32 x 23 | 7,0 | ● |



Baguette Korb, oval „PROFI LINE“
basket, oval
cesta, oval
corbeille à baguettes, ovale



| | □ cm | ↑ cm | |
|---------|---------|------|---|
| 50805 7 | 28 x 16 | 8 | ● |
| 50820 0 | 40 x 16 | 8 | ● |
| 50806 4 | 28 x 16 | 8 | ● |
| 50821 7 | 40 x 16 | 8 | ● |
| 50807 1 | 28 x 16 | 8 | ● |
| 50822 4 | 40 x 16 | 8 | ● |



50810

Korb, oval „PROFI LINE“
basket, oval
cesta oval
corbeille ovale



| | ☐ cm | ↑ cm | |
|---------|-------------|------|---|
| 50810 1 | 29,5 x 20,5 | 13 | ● |
| 50811 8 | 29,5 x 20,5 | 13 | ● |
| 50812 5 | 29,5 x 20,5 | 13 | ● |



50811



50812



50700

Korb, rechteckig „PROFI LINE“
basket, rectangular
cesta rectangular
corbeille rectangulaire



| | ☐ cm | ↑ cm | |
|---------|-------------|------|---|
| 50700 5 | 26,5 x 19,0 | 7 | ● |
| 50705 0 | 31,0 x 21,0 | 9 | ● |
| 50701 2 | 26,5 x 19,0 | 7 | ● |
| 50706 7 | 31,0 x 21,0 | 9 | ● |
| 50702 9 | 26,5 x 19,0 | 7 | ● |
| 50707 4 | 31,0 x 21,0 | 9 | ● |



50701



50707



50710

Korb, rechteckig „PROFI LINE“
basket, rectangular
cesta rectangular
corbeille rectangulaire



| | ☐ cm | ↑ cm | |
|---------|---------|------|---|
| 50710 4 | 40 x 30 | 10 | ● |
| 50711 1 | 40 x 30 | 10 | ● |
| 50712 8 | 40 x 30 | 10 | ● |



50711



50712

PROFI LINE

GASTRONORM-SYSTEM



2 Höhen - 6,5 und 10 cm
2 highs - 6,5 and 10 cm



40293
GN1/1 - 10 cm



40225
GN1/4 - 6,5 cm

40292
GN1/2 - 10 cm

GN Korb „PROFI LINE“ basket GN cesta GN corbeille GN



stabile Ausführung mit Edelstahldraht im Rand zur Stabilisierung
very solid with stainless steel wire frame to stabilize the basket
muy resistente con refuerzo de alambre inox
très résistante avec son fil de renfort inox

| | cm | cm | GN | |
|---------|-------------|------|-----|---|
| 40291 1 | 53,0 x 32,5 | 6,5 | 1/1 | ● |
| 40290 4 | 32,5 x 26,5 | 6,5 | 1/2 | ● |
| 40223 2 | 32,5 x 17,5 | 6,5 | 1/3 | ● |
| 40225 6 | 26,5 x 16,2 | 6,5 | 1/4 | ● |
| 40227 0 | 17,6 x 16,2 | 6,5 | 1/6 | ● |
| 40229 4 | 32,5 x 35,4 | 6,5 | 2/3 | ● |
| 40293 5 | 53,0 x 32,5 | 10,0 | 1/1 | ● |
| 40292 8 | 32,5 x 26,5 | 10,0 | 1/2 | ● |
| 40243 0 | 32,5 x 17,5 | 10,0 | 1/3 | ● |
| 40245 4 | 26,5 x 16,2 | 10,0 | 1/4 | ● |
| 40247 8 | 17,6 x 16,2 | 10,0 | 1/6 | ● |
| 40249 2 | 32,5 x 35,4 | 10,0 | 2/3 | ● |



GN1/1

Besteckbehälter dispenser dispensador de cubiertos bac à couverts



4 Mulden, Kunststoff-Geflecht, Drahtgestell, braun-schwarz
4 compartments, with reinforced chromed wire structure, brown-black
4 compartimentos, cesta trensada de plástico con bastidor cromado reforzado, marrón oscuro
4 compartiments, corbeille en plastique tressé, cadre acier chromé renforcé, couleur marron foncé

| | cm | cm | GN | |
|---------|-----------|----|-----|---|
| 11966 6 | 53 x 32,5 | 9 | 1/1 | ● |

PROFI LINE

GASTRONORM-SYSTEM

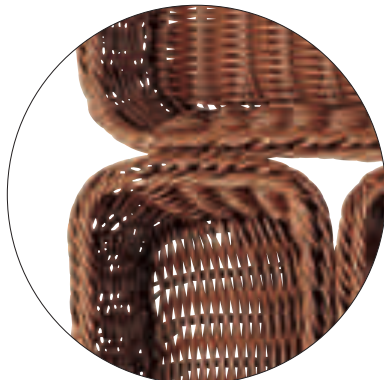

2 Höhen
6,5 und 10 cm

GN1/6
40228



GN1/2
40222



GN1/1
40220



GN1/4
40264

GN1/2
40272



GN1/2
40272

GN Korb „PROFI LINE“ basket GN cesta GN corbeille GN



stabile Ausführung mit Edelstahldraht im Rand zur Stabilisierung
very solid with stainless steel wire frame to stabilize the basket
muy resistente con refuerzo de alambre inox
très résistante avec son fil de renfort inox

| | cm | cm | GN | |
|---------|-------------|-----|-----|---|
| 40220 1 | 53 x 32,5 | 6,5 | 1/1 | ● |
| 40222 5 | 32,5 x 26,5 | 6,5 | 1/2 | ● |
| 40224 9 | 32,5 x 17,6 | 6,5 | 1/3 | ● |
| 40226 3 | 26,5 x 16,2 | 6,5 | 1/4 | ● |
| 40228 7 | 17,6 x 16,2 | 6,5 | 1/6 | ● |
| 40230 0 | 32,5 x 35,4 | 6,5 | 2/3 | ● |
| 40240 9 | 53 x 32,5 | 10 | 1/1 | ● |
| 40242 3 | 32,5 x 26,5 | 10 | 1/2 | ● |
| 40244 7 | 32,5 x 17,6 | 10 | 1/3 | ● |
| 40246 1 | 26,5 x 16,2 | 10 | 1/4 | ● |
| 40248 5 | 17,6 x 16,2 | 10 | 1/6 | ● |
| 40250 8 | 32,5 x 35,4 | 10 | 2/3 | ● |
| 40260 7 | 53 x 32,5 | 6,5 | 1/1 | ● |
| 40262 1 | 32,5 x 26,5 | 6,5 | 1/2 | ● |
| 40263 8 | 32,5 x 17,6 | 6,5 | 1/3 | ● |
| 40264 5 | 26,5 x 16,2 | 6,5 | 1/4 | ● |
| 40266 9 | 17,6 x 16,2 | 6,5 | 1/6 | ● |
| 40268 3 | 32,5 x 35,4 | 6,5 | 2/3 | ● |
| 40270 6 | 53 x 32,5 | 10 | 1/1 | ● |
| 40272 0 | 32,5 x 26,5 | 10 | 1/2 | ● |
| 40274 4 | 32,5 x 17,6 | 10 | 1/3 | ● |
| 40276 8 | 26,5 x 16,2 | 10 | 1/4 | ● |
| 40278 2 | 17,6 x 16,2 | 10 | 1/6 | ● |
| 40280 5 | 32,5 x 35,4 | 10 | 2/3 | ● |

EAN = 40 04 133 XXXX X

351



rund

Tisch- und Buffetkorb, rund „ECONOMIC“
buffet basket, round
cesta de bufet redonda
corbeille à pain ronde



| | □ cm | ↑ cm | |
|---------|--------|------|---|
| 40132 7 | Ø 19,0 | 9,5 | ● |
| 40135 8 | Ø 25,5 | 8,5 | ● |
| 40144 0 | Ø 39,0 | 10,0 | ● |
| 40191 4 | Ø 19,0 | 9,5 | ● |
| 40192 1 | Ø 25,5 | 8,5 | ● |



oval

Tisch- und Buffetkorb, oval „ECONOMIC“
buffet basket, oval
cesta de bufet oval
corbeille de buffet ovale



| | □ cm | ↑ cm | |
|---------|-------------|------|---|
| 40137 2 | 23,0 x 17,0 | 8,0 | ● |
| 40139 6 | 28,5 x 17,0 | 8,5 | ● |
| 40146 4 | 37,0 x 27,5 | 9,0 | ● |
| 40193 8 | 23,0 x 17,0 | 8,0 | ● |
| 40194 5 | 28,5 x 17,0 | 8,5 | ● |



rechteckig

Tisch- und Buffetkorb, eckig „ECONOMIC“
buffet basket rectangular
cesta de bufet rectangular
corbeille de buffet rectangulaire



| | □ cm | ↑ cm | |
|---------|-------------|------|---|
| 40140 2 | 23,0 x 17,0 | 8 | ● |
| 40159 4 | 31,5 x 22,0 | 8,5 | ● |
| 40195 2 | 23,0 x 17,0 | 8 | ● |
| 40196 9 | 31,5 x 22,0 | 8,5 | ● |



Buffet-Korb GN
GN basket
cesta GN
corbeille GN



| | □ cm | ↑ cm | GN |
|---------|-------------|------|-----|
| 40152 5 | 32,5 x 26,5 | 8 | 1/2 |
| 40148 8 | 53 x 32,5 | 8 | 1/1 |



Buffet- und Auslagekorb
buffet basket
cesta de bufet
corbeille de buffet



stabile Ausführung mit Edelstahldraht im Rand zur Stabilisierung
 very solid with stainless steel wire frame to stabilize the basket
 muy resistente con refuerzo de alambre inox
 très résistante avec son fil de renfort inox

| | □ cm | ↑ cm |
|---------|---------|------|
| 40161 7 | 50 x 25 | 6 |
| 40160 0 | 50 x 20 | 6 |

Ergänzung:
Kuppelhaube
11027



Buffet-Korb
40129

Buffet-Korb
buffet basket
cesta de bufet
corbeille de buffet



stabile Ausführung mit Edelstahldraht im Rand zur Stabilisierung
very solid with stainless steel wire frame to stabilize the basket
muy resistente con refuerzo de alambre inox
très résistante avec son fil de renfort inox

| | □ cm | ↑ cm | GN |
|---------|-----------|------|-----|
| 40129 7 | 53 x 32,5 | 15,5 | 1/1 |

Einzelteile / spare parts / piezas sueltas / pièces détachées

GN Kuppelhaube / GN cover / GN cúpula / GN cloche bombée

| | | | |
|---------|---------|----|--|
| 11027 4 | 54 x 33 | 20 | |
|---------|---------|----|--|



Buffet-Korb „LARGE“
buffet basket
cesta de bufet
corbeille de buffet



stabile Ausführung mit Edelstahldraht im Rand zur Stabilisierung
very solid with stainless steel wire frame to stabilize the basket
muy resistente con refuerzo de alambre inox
très résistante avec son fil de renfort inox

| | □ cm | ↑ cm |
|---------|---------|---------|
| 40153 2 | 45 x 42 | 17 / 24 |



Buffet-Korb
buffet basket
cesta de bufet
corbeille de buffet



| | □ cm | ↑ cm |
|---------|------|------|
| 40126 6 | Ø 40 | 7,5 |
| 40128 0 | Ø 46 | 7,5 |



40149

Buffet-Korb „RUND“
buffet basket „ROUND“
cesta de bufet „ROUND“
corbeille de buffet ronde



stabile Ausführung mit Edelstahldraht im Rand zur Stabilisierung
very solid with stainless steel wire frame to stabilize the basket
muy resistente con refuerzo de alambre inox
très résistante avec son fil de renfort inox

| | □ cm | ↑ cm |
|---------|------|------|
| 40149 5 | Ø 40 | 12,5 |



18388

Einzelteile / spare parts / piezas sueltas / pièces détachées

Rolltop-Haube / rolltop cover / campana abatible / cloche basculante

| | | | |
|---------|------|----|---|
| 18388 9 | Ø 38 | 20 | mit verchromtem Kugelgriff chrome plated handle pomo cromado bouton chromé |
| 18387 2 | Ø 38 | 20 | mit vergoldetem Kugelgriff gold plated handle pomo dorado bouton doré |



40198

Baguette-Korb
baguette basket
cesta para baguette
corbeille pour baguettes



stabile Ausführung mit Edelstahldraht im Rand zur Stabilisierung
 very solid with stainless steel wire frame to stabilize the basket
 muy resistente con refuerzo de alambre inox
 très résistante avec son fil de renfort inox

| | □ cm | ↑ cm | |
|---------|------|---------|---|
| 40198 3 | Ø 35 | 25 / 42 | ● |
| 40199 0 | Ø 35 | 25 / 42 | ● |



40179

Besteck-Korb „ECONOMIC“
cutlery dispenser
dispensador de cubiertos
corbeille à couverts



4 Fächer, 3 kleine Fächer, 1 großes Fach
 4 troughs
 4 huecos
 4 classements

| | □ cm | ↑ cm | |
|---------|---------|------|---|
| 40179 2 | 26 x 18 | 15 | ● |
| 40182 2 | 26 x 18 | 15 | ● |



40182



40007

40130

Besteck-Korb
cutlery dispenser
dispensador de cubiertos
corbeille à couverts



| | □ cm | ↑ cm | |
|---------|------|------|---|
| 40130 3 | Ø 12 | 15,0 | ● |
| 40007 8 | Ø 12 | 15,0 | ● |



40131



40009

Besteck-Korb
cutlery dispenser
dispensador de cubiertos
corbeille à couverts



| | □ cm | ↑ cm | |
|---------|---------|------|---|
| 40131 0 | 27 x 10 | 4,5 | ● |
| 40009 2 | 27 x 10 | 4,5 | ● |



Besteck-Korb „ECONOMIC“
cutlery dispenser
dispensador de cubiertos
corbeille à couverts



| | □ cm | ↑ cm |
|---------|---------|------|
| 40287 4 | 12 x 12 | 15 |



Besteck-Korb „ECONOMIC“
cutlery dispenser
dispensador de cubiertos
corbeille à couverts



| | □ cm | ↑ cm |
|---------|------|------|
| 40286 7 | Ø 12 | 15 |

BROT- UND OBSTKORB „BASIC“
BASKET FOR BREAD OR FRUITS
CESTA PARA PAN O FRUTA
CORBEILLE À PAIN OU À FRUITS

in Handarbeit geflochten, einfache und leichte Ausführung.
wickerwork, simple and light version.
lígera, trensada a mano
tressé main, version légère

HOT PRICE

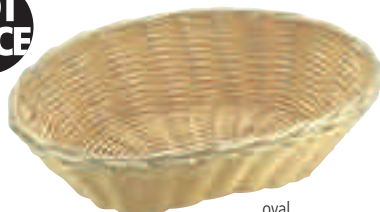

oval

Brot- und Obstkorb oval „BASIC“
basket for bread or fruits
cesta para pan o fruta
corbeille à pain ou à fruits



| | □ cm | ↑ cm |
|---------|---------|------|
| 30279 2 | 18 x 12 | 7 |
| 30280 8 | 23 x 15 | 6 |

HOT PRICE

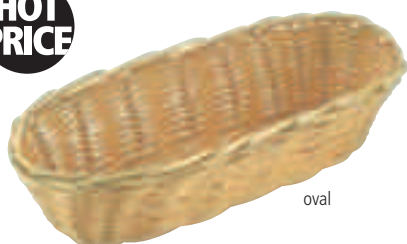

oval

Brot- und Obstkorb oval „BASIC“
basket for bread or fruits
cesta para pan o fruta
corbeille à pain ou à fruits



| | □ cm | ↑ cm |
|---------|---------|------|
| 30282 2 | 21 x 10 | 6 |
| 30284 6 | 36 x 15 | 7 |

HOT PRICE



rund

Brot- und Obstkorb rund „BASIC“
buffet basket
cesta de bufet
corbeille de buffet



| | □ cm | ↑ cm |
|---------|------|------|
| 30281 5 | Ø 20 | 7 |
| 30285 3 | Ø 25 | 7 |

HOT PRICE

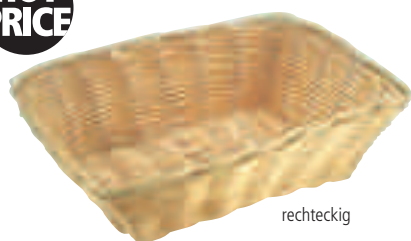

rechteckig

Tisch- und Buffet-Korb rechteckig „BASIC“
buffet basket
cesta de bufet
corbeille de buffet



| | □ cm | ↑ cm |
|---------|---------|------|
| 30283 9 | 22 x 15 | 6 |
| 30286 0 | 30 x 22 | 7 |
| 30288 4 | 41 x 29 | 7 |

HOT PRICE



quadratisch

Brot- und Obstkorb quadratisch „BASIC“
basket for bread or fruits
cesta para pan o fruta
corbeille à pain ou à fruits



| | □ cm | ↑ cm |
|---------|---------|------|
| 30287 7 | 24 x 24 | 6 |



Brot- und Obstkorb
basket
cesta para pan o fruta
corbeille à pain ou à fruits



| | | |
|---------|------|------|
| | □ cm | ↑ cm |
| 40125 9 | Ø 23 | 7 |



Brot- und Obstkorb
basket
cesta para pan o fruta
corbeille à pain ou à fruits



| | | |
|---------|---------|------|
| | □ cm | ↑ cm |
| 40127 3 | 27 x 20 | 10 |

Eier-Korb
egg basket
cesta de huevos
panier à oeufs



stabile Vollweide, hält den Inhalt durch das sehr dicht verarbeitete Stoff-Futter lange warm
willow, stable, keeps eggs warm
ratán, calidad fuerte, mantiene los huevos calientes
rotin, résistant, belle qualité, pour maintenir les oeufs bien chauds

| | | |
|---------|------|------|
| | □ cm | ↑ cm |
| 30299 0 | Ø 26 | 17 |

für ca. 20 Eier



40150



40148

Buffet-Korb
buffet basket
cesta buffet
corbeille buffet



in Handarbeit geflochten, stabile Ausführung, Edelstahl Fixierungsrahmen, zur Rutschsicherung, ohne Haube

wickerwork, stainless steel fix the cover, without cover

cesta trensada a mano, con marco cromado patentado para fijar y encajar la campana (se sirve sin la campana)

corbeille tressée main, cadre fil acier inoxydable pour fixer la cloche (livré sans la cloche)

| | □ cm | ↑ cm | GN |
|---|-----------|------|-----|
| 40150 1 | 56,5 x 36 | 10 | |
| Buffet-Korb mit Fixierahmen / basket with frame to fix cesta con marco de fijación / corbeille avec cadre de fixation | | | |
| 40148 8 | 53 x 32,5 | 8 | 1/1 |
| Buffet-Korb ohne Fixierahmen / basket without frame to fix cesta borde reforzada (sin fijación campana) / corbeille bord renforcé (sans cadre de fixation cloche) | | | |

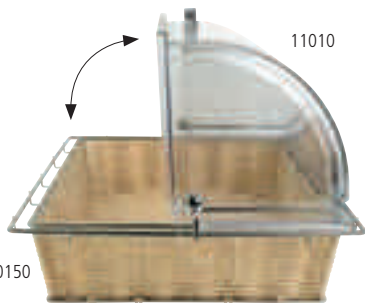

11010

40150



11010

Rolltop-Haube GN1/1
rolltop cover
campana rolltop
cloche rolltop



patentiert, passend für GN-Behälter, -Tablets, etc., leichtgängig auf- und zuklappbar 90°, temperaturbeständig -30°C bis ca. 120°C

patented, suitable for GN trays, solid quality, 90° opening, heat-resistant -30°C to 120°C

patentada, pomo dorado, apertura 90°, temperatura -30°C a +120°C

brevetée, bouton doré, ouverture 90°, température -30°C à +120°C

| | □ cm | ↑ cm | GN |
|--|-------------|------|-----|
| 11008 3 | 53 x 32,5 | 19 | 1/1 |
| vergoldeter Griff / gold plated handle pomo dorado / bouton doré | | | |
| 11010 6 | 53,0 x 32,5 | 19 | 1/1 |
| verchromter Griff / chrome plated handle pomo cromado / bouton chromé | | | |

designed by **CULTURE FORM**



GN1/2
11021



GN1/1
11026



11027



11028



GN Kuppelhaube
GN cover
GN cúpula
GN cloche bombée



glasklarer Kunststoff, Griff verchromt

clear, chrome knob

transparente, asa cromada

transparente, anse chromée

| | □ cm | ↑ cm | |
|--------------|---------|------|--|
| 11021 2 | 33 x 28 | 17 | geschlossen / totally closed cerrada / tolement fermée |
| GN1/2 | | | |
| 11022 9 | 33 x 28 | 17 | mit Front-Ausschnitt / one long side cut out gran apertura frontal / grande ouverture frontale |
| GN1/2 | | | |
| 11026 7 | 54 x 33 | 20 | geschlossen / totally closed cerrada / tolement fermée |
| GN1/1 | | | |
| 11027 4 | 54 x 33 | 20 | mit Front-Ausschnitt / one long side cut out gran apertura frontal / grande ouverture frontale |
| GN1/1 | | | |
| 11028 1 | 54 x 33 | 20 | mit seitlichem Ausschnitt / one small side cut out pequeña apertura frontal / petite ouverture frontale |
| GN1/1 | | | |

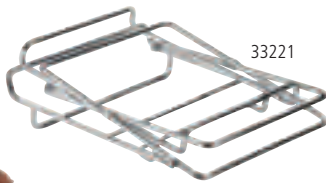

33221

Buffet-Gestell für Körbe
buffet stand for baskets
expositor para cestas
support métal pour corbeilles



2-stufig, für 2 rechteckige Körbe, platzsparend zusammenklappbar, Lieferung ohne Körbe
 2-tier, for 2 rectangular baskets, can be folded, place saving, delivery without baskets
 2 alturas, para 2 cestas rectangulares, totalmente plegable para ahorrar espacio. Se sirve sin cestas
 2 hauteurs, pour 2 corbeilles rectangulaires. Pliable pour son rangement. Livré sans corbeilles.



40222



40262



| | □ cm | ↑ cm |
|---------|---------|---------|
| 33221 8 | 46 x 24 | 18 - 21 |

Einzelteile / spare parts / piezas sueltas / pièces détachées

Tisch- und Buffet-Korb rechteckig „BASIC“ / buffet basket / cesta de bufet / corbeille de buffet

| | | | |
|---------|-------------|-----|---|
| 30286 0 | 30,0 x 22,0 | 7 | ● |
| 30288 4 | 41,0 x 29,0 | 7 | ● |
| 40154 9 | 30,0 x 24,5 | 8 | ● |
| 40159 4 | 31,5 x 22,0 | 8,5 | ● |
| 40161 7 | 50,0 x 25,0 | 6 | ● |
| 40222 5 | 32,5 x 26,5 | 6,5 | ● |
| 40242 3 | 32,5 x 26,5 | 10 | ● |
| 40262 1 | 32,5 x 26,5 | 6,5 | ● |
| 40272 0 | 32,5 x 26,5 | 10 | ● |



2 Größen:
 GN1/2
 GN1/1

Buffet-Gestell „DOPPELDECKER“
buffet frame
estructura para buffet
support buffet



für GN, 2-teilig, einfach zusammensetzbar, Etagen-Abstand ca. 26 cm, platzsparend, stabile Ausführung
 for GN, 2 pcs. frame, easy to assemble, distance between the tiers approx 26 cm, space-saving, robust
 para bandejas GN, fácil de montar, distancia entre pisos aprox. 26 cm, robusto
 pour corbeilles ou plats GN, 2 étages, distance entre niveaux approx. 26 cm, robuste

| | □ cm | ↑ cm | GN |
|---------|---------|------|-----|
| 11553 8 | 29 x 27 | 35 | 1/2 |
| 11555 2 | 50 x 34 | 37,5 | 1/1 |



40152

GN1/2



40154

GN1/1

11100

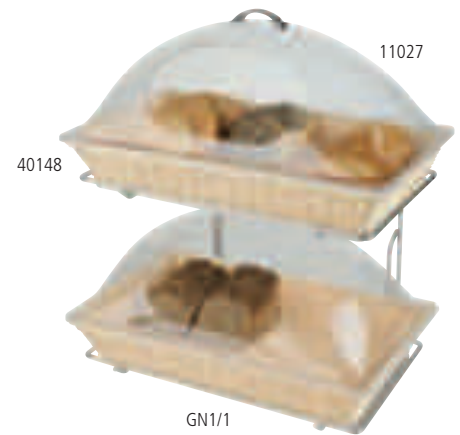

40148

GN1/1

11027

NEW



30203



30204

Brot- und Obstkorb inklusive Brottasche
basket
cesta
corbeille



mit Baumwoll-Einleger, maschinenwaschbar bis 30°C
 with cotton-inliner, mashine-washable 30°C
 algodón, lavable a máquina 30°C
 coton, lavable en machine maxi 30°C

| | □ cm | ↑ cm | | |
|---------|------|------|---|---------------|
| 30203 7 | Ø 20 | 9 | ● | chrome / grey |
| 30204 4 | Ø 23 | 9 | ● | chrome / grey |



30340, 30350



30361, 30371

Brottasche
bread basket
panera
corbeille à pain en toile



Baumwolle, umgekrempelt kann die Höhe individuell gestaltet werden, maschinenwaschbar bis 30°C, rund oder oval
 cotton, adjustable height, mashine-washable 30°C, round or oval
 algodón, altura ajustable, lavable a máquina 30°C, redondo u oval
 coton, hauteur ajustable, lavable en machine maxi 30°C, rond ou ovale

| | □ cm | ↑ cm | | |
|---------|---------|------|---|-------------------------------|
| 30340 9 | Ø 17 | 8 | ● | beige |
| 30350 8 | Ø 20 | 9 | ● | beige |
| 30360 7 | 20 x 15 | 7 | ● | beige |
| 30370 6 | 25 x 18 | 9 | ● | beige |
| 30341 6 | Ø 17 | 8 | ● | beige, schwarz / beige, black |
| 30351 5 | Ø 20 | 9 | ● | beige, schwarz / beige, black |
| 30361 4 | 20 x 15 | 7 | ● | beige, schwarz / beige, black |
| 30371 3 | 25 x 18 | 9 | ● | beige, schwarz / beige, black |



mit Zugverschluss



Das Wärmekissen einfach in der Mikrowelle erhitzen (90 Sekunden / 500 Watt)

maschinenwaschbar bis 30°C (außer Wärmekissen)

Brottasche mit Wärmekissen
bread basket with stones pillow
panera con cojin
corbeille à pain entoile



Baumwolle, Keramik-Kugeln
 cotton, ceramic stones
 algodón
 coton

| | □ cm | ↑ cm | | |
|---------|------|------|---|-----------------------------|
| 30380 5 | Ø 20 | 23,5 | ● | beige |
| 30390 4 | Ø 20 | 23,5 | ● | beige, braun / beige, brown |

Einzelteile / spare parts / piezas sueltas / pièces détachées

Wärmekissen, einfach in der Mikrowelle zu erhitzen (90 Sekunden / 500 Watt)
 stones pillow, easy to heat up in the microwave (90 seconds / 500 watt)
 cojín de piedrecillas a calentar, se calienta rápido en el microondas (90 seg. -500 W.)
 coussin de petites pierres, à chauffer, chauffe rapide en micro-ondes (90 sec. - 500W.)

| | | | | |
|---------|------|-----|--|--|
| 30385 0 | Ø 19 | 1,5 | | |
|---------|------|-----|--|--|

WICKER LOOK

sehr formstabil, Kunststoff gespritzt



NEW

40234
Ø 20 cm



HOT PRICE



40215
oval 23 x 17 cm



40213
Ø 20 cm

Brot- und Obstkorb „WICKER-LOOK“ basket cesta corbeille



| | □ cm | ↑ cm | |
|---------|---------|------|-------------------|
| 40234 8 | Ø 20 | 6,5 | ● grün / green |
| 40235 5 | Ø 20 | 6,5 | ● rot / red |
| 40213 3 | Ø 20 | 6,5 | ● beige / beige |
| 40214 0 | Ø 20 | 6,5 | ● schwarz / black |
| 40236 2 | 23 x 17 | 6,5 | ● grün / green |
| 40237 9 | 23 x 17 | 6,5 | ● rot / red |
| 40215 7 | 23 x 17 | 6,5 | ● beige / beige |
| 40216 4 | 23 x 17 | 6,5 | ● schwarz / black |

40237
oval 23 x 17 cm



40214
Ø 20 cm



40216
oval 23 x 17 cm

HOT PRICE

Korb „WICKER-LOOK“ basket cesta corbeille



40210
beige



40211
braun



40212
schwarz

| | □ cm | ↑ cm | |
|---------|-------------|------|-------------------|
| 40210 2 | 39,5 x 29,5 | 10 | ● beige / beige |
| 40211 9 | 39,5 x 29,5 | 10 | ● braun / brown |
| 40212 6 | 39,5 x 29,5 | 10 | ● schwarz / black |

EAN = 40 04 133 XXXXX X



Brot- und Obstkorb
basket for bread or fruits
cesta para pan o fruta
corbeille à pain ou à fruits



rund

hochglanzpoliert
 mirror polished finish
 acabado pulido brillante
 brillant

| | □ cm | ↑ cm | |
|---------|---------|------|--------------------------------|
| 30200 6 | Ø 17,5 | 7 | rund / round / redondo / ronde |
| 30220 4 | Ø 20,5 | 8,5 | rund / round / redonda / ronde |
| 30230 3 | Ø 25,5 | 9,5 | rund / round / redonda / ronde |
| 30210 5 | 20 x 15 | 7 | oval |
| 30240 2 | 24 x 19 | 8,5 | oval |
| 30250 1 | 28 x 21 | 9,5 | oval |



oval



Obstkorb
basket for fruits
cesta para fruta
corbeille à fruits



hochglanzpoliert
 mirror polished finish
 acabado brillante
 brillant

| | □ cm | ↑ cm |
|---------|--------|------|
| 30270 9 | Ø 21,5 | 20,5 |



Grissini-Halter
breadstick holder
porta grissini
porte- bâtonnets de pain (grissini)



hochglanzpoliert
 mirror polished finish
 acabado brillante
 brillant

| | □ cm | ↑ cm |
|---------|-------|------|
| 30272 3 | Ø 9,5 | 13,5 |

NEW



30201
stainless steel

Brot- und Obstkorb mit Tragegriff
basket for bread or fruits
cesta para pan o fruta
corbeille à pain ou à fruits



| | □ cm | ↑ cm | |
|---------|---------|------|-----------------------------|
| 30201 3 | 24 x 24 | 21 | Edelstahl / stainless steel |
| 30202 0 | 24 x 24 | 21 | ● kupfer-look / copper-look |



30202
copper-look

HOT PRICE

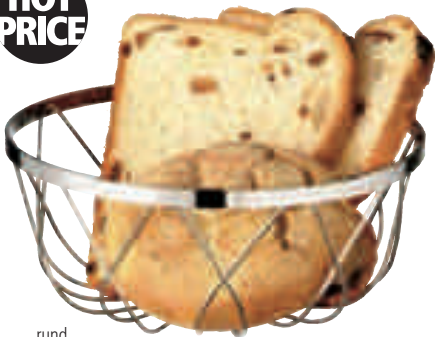

rund

Tischkorb
basket
cesta
corbeille



| | □ cm | ↑ cm |
|---------|------|------|
| 30310 2 | Ø 18 | 7,5 |
| 30320 1 | Ø 23 | 9 |

HOT PRICE



rund

30277



30276

Brot- und Obstschale
bowl for bread or fruits
bol para pan o frutas
bol à pain ou à fruits



hochglanzpoliert, Hammerschlag Optik
mirror polished finish, hammered look
acabado pulido efecto espejo, aspecto repujado
brillant, aspect martelé

| | □ cm | ↑ cm |
|---------|------|------|
| 30276 1 | Ø 16 | 5 |
| 30277 8 | Ø 20 | 5,5 |

HOT PRICE



oval

Edelstahl-Schale
bowl
bandeja ovalada inox
corbeille ovale inox



ingerollter Rand
rolled edge
borde redondeado
bord roulé

| | □ cm | ↑ cm |
|---------|-------------|------|
| 40110 5 | 26,5 x 18,5 | 4 |
| 40115 0 | 31 x 21 | 4,5 |

TISCHSETS



60528 - grün/green

Tischset Schmalband
placemat smallband
mantelin cinta estrecha
set de tables tressage étroit



| | cm | | VE / Unit |
|---------|---------|-----------------|-----------|
| 60525 1 | 45 x 33 | weiß / white | 6 |
| 60526 8 | 45 x 33 | gold / gold | 6 |
| 60527 5 | 45 x 33 | silber / silver | 6 |
| 60528 2 | 45 x 33 | grün / green | 6 |

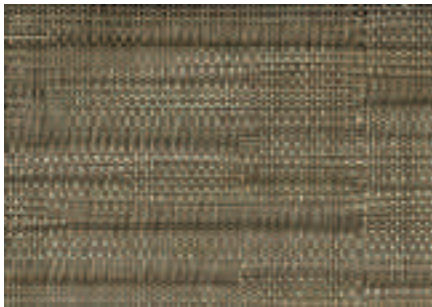

60526 - gold/gold

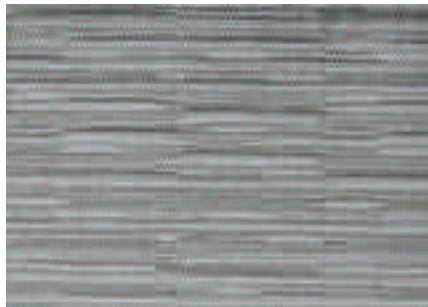

60525 - weiß/white



60527 - silber/silver



60538 - Bambus natur

Tischset „BAMBUS“
placemat
mantelin
set de table individual



Original Natur-Bambus, handgemacht
 original nature bamboo, hand made
 bambú natural hecho a mano
 bambou naturel, fabriqué main

| | cm | | VE / Unit |
|---------|---------|----------------|-----------|
| 60538 1 | 45 x 33 | natur / nature | 6 |
| 60539 8 | 45 x 33 | grün / green | 6 |



60539 - Bambus grün

NEW

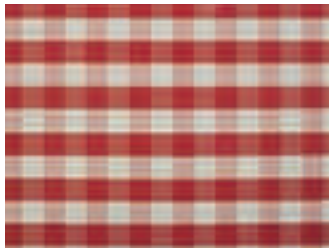

60004

**Tischset Schmalband
placemat smallband
mantelin cinta estrecha
set de tables tressage étroit**



| | cm | | VE / Unit |
|---------|---------|-----------------------------------|-----------|
| 60004 1 | 45 x 33 | rot kariert / red checkered | 6 |
| 60005 8 | 45 x 33 | blau kariert / blue checkered | 6 |
| 60006 5 | 45 x 33 | schwarz kariert / black checkered | 6 |



60004 - rot kariert / red checkered



60005 - blau kariert / blue checkered

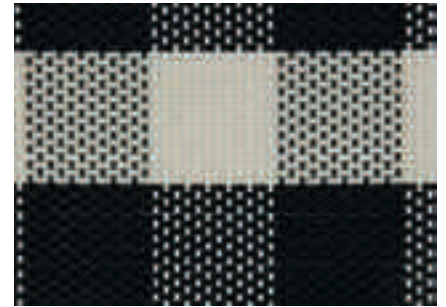

60006 - schwarz kariert / black checkered



60535 - gold / gold

**Tischset „CROCO“
placemat
mantelin
set de table individual**



rutschhemmende Unterseite
slip resistant underside
antideslizante por debajo
dessous anti-glisse

| | cm | | VE / Unit |
|---------|---------|-----------------|-----------|
| 60535 0 | 45 x 30 | gold / gold | 6 |
| 60536 7 | 45 x 30 | kupfer / copper | 6 |
| 60537 4 | 45 x 30 | braun / brown | 6 |



60536 - kupfer / copper



60537 - braun / brown



60008 - schwarz
VE 6 / unit 6

**Tischset Breitband
placemat wide band
mantelines de mesa
sets de tables**



| | cm | | VE / Unit |
|---------|---------|------------------------|-----------|
| 60000 3 | 45 x 33 | sahara / sahara | 6 |
| 60001 0 | 45 x 33 | beige / beige | 6 |
| 60003 4 | 45 x 33 | braun / brown | 6 |
| 60007 2 | 45 x 33 | blau / blue | 6 |
| 60008 9 | 45 x 33 | schwarz / black | 6 |
| 60010 2 | 45 x 33 | anthrazit / anthracite | 6 |
| 60030 0 | 45 x 33 | plum | 6 |
| 60031 7 | 45 x 33 | lime | 6 |
| 60032 4 | 45 x 33 | grasgrün / grass green | 6 |



60000 - sahara

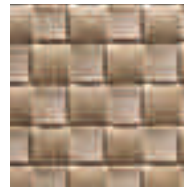

60001 - beige



60003 - braun



60007 - kobaltblau



60010 - anthrazit

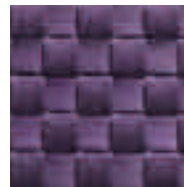

60030 - plum



60031 - lime



60032 - grasgrün



60018 - candyrot
VE 6 / unit 6

**Tischset Schmalband
placemat smallband
mantelin cinta estrecha
set de table tressage étroit**



| | cm | | VE / Unit |
|--------------------|---------|----------------------------------|-----------|
| NEW 60002 7 | 45 x 33 | hellblau / light blue | 6 |
| NEW 60009 6 | 45 x 33 | rot / red | 6 |
| NEW 60011 9 | 45 x 33 | orange / orange | 6 |
| 60012 6 | 45 x 33 | schwarz / black | 6 |
| 60014 0 | 45 x 33 | beige / beige | 6 |
| 60015 7 | 45 x 33 | silbergrau / silvergrey | 6 |
| 60016 4 | 45 x 33 | grün / green | 6 |
| 60017 1 | 45 x 33 | lila / purple | 6 |
| 60018 8 | 45 x 33 | candyrot / candyred | 6 |
| 60019 5 | 45 x 33 | beige, braun / beige, brown | 6 |
| 60520 6 | 45 x 33 | schwarz, weiß / black, white | 6 |
| 60521 3 | 45 x 33 | apfelgrün / apple green | 6 |
| 60522 0 | 45 x 33 | orange / orange | 6 |
| 60523 7 | 45 x 33 | purple, violett / purple, violet | 6 |
| 60524 4 | 45 x 33 | platin / platinum | 6 |

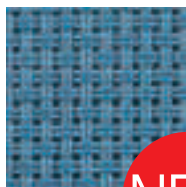

60002 - hellblau



60009 - rot



60011 - orange

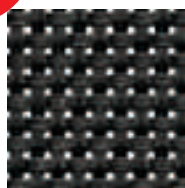

60012 - schwarz



60014 - beige



60015 - silbergrau

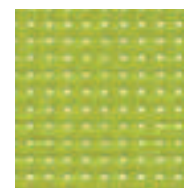

60016 - grün

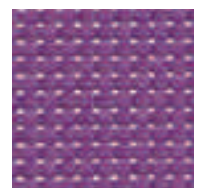

60017 - lila



60019 - beige, braun

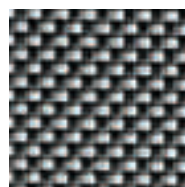

60520 - schwarz, weiß



60521 - apfelgrün



60522 - orange



60523 - purple, violett

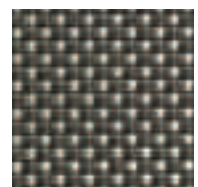

60524 - platin



60509 - Mosaik schwarz, grau
VE 6 / unit 6

Tischset Feinband
placemat fine band
mantelines
sets de tables



| | cm | | VE / Unit |
|---------|---------|------------------------------------|-----------|
| 60509 1 | 45 x 33 | Mosaik schwarz, grau / black, grey | 6 |
| 60512 1 | 45 x 33 | schwarz, grau / black, grey | 6 |
| 60542 8 | 45 x 33 | rot / red | 6 |

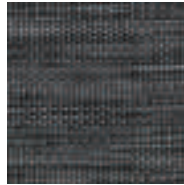

60512 - schwarz, grau



60542 - rot



60510 - orange, rot gestreift
VE 6 / unit 6

Tischset Feinband
placemat fine band
mantelines
sets de table tressage fin



| | cm | | VE / Unit |
|---------|---------|---|-----------|
| 60510 7 | 45 x 33 | LINES orange, rot / LINES orange, red | 6 |
| 60511 4 | 45 x 33 | LINES orange, gelb / LINES orange, yellow | 6 |
| 60530 5 | 45 x 33 | STRIPES grau / STRIPES grey | 6 |
| 60531 2 | 45 x 33 | LINES schwarz / LINES black | 6 |
| 60532 9 | 45 x 33 | LINES pastell / LINES pastell | 6 |
| 60533 6 | 45 x 33 | LINES bordeaux / LINES bordeaux | 6 |
| 60534 3 | 45 x 33 | LINES rot / LINES red | 6 |
| 60540 4 | 45 x 33 | FRAMES grau / grey FRAMES | 6 |
| 60541 1 | 45 x 33 | FRAMES schwarz / black FRAMES | 6 |



60511 - orange, gelb gestreift

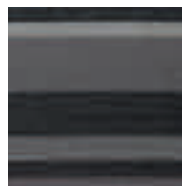

60531 - schwarz gestreift

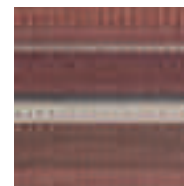

60532 - pastell gestreift

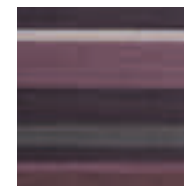

60533 - bordeaux gestreift



60534 - rot gestreift

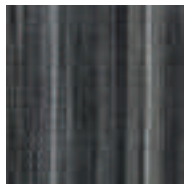

60530 - grau gestreift

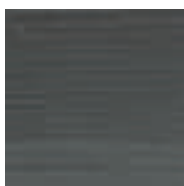

60540 - grau FRAMES



60541 - schwarz FRAMES



60501 - Mosaik, grau
VE 6 / unit 6

Tischset Feinband „TAO“
placemat fine band
mantelines
sets de table, tressage fin TAO



| | cm | | VE / Unit |
|---------|---------|-----------------------------|-----------|
| 60500 8 | 45 x 33 | schwarz / black | 6 |
| 60501 5 | 45 x 33 | Mosaik, grau / mosaik, grey | 6 |
| 60502 2 | 45 x 33 | grau, beige / grey, beige | 6 |
| 60503 9 | 45 x 33 | beige / beige | 6 |
| 60504 6 | 45 x 33 | schwarz, gold / black, gold | 6 |
| 60505 3 | 45 x 33 | braun / brown | 6 |



60500 - schwarz



60502 - grau, beige



60503 - beige

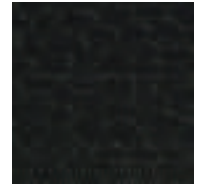

60504 - schwarz, gold



60505 - braun



Tischset Feinband „GEDECK“
placemat fine band
mantelines
sets de tables



Motiv Teller / Besteck
 motive plate, knife and fork
 montel individual, tressado fino
 set de table individuel, tressage fin

| | cm | | VE / Unit |
|---------|---------|-----------------|-----------|
| 60513 8 | 45 x 33 | schwarz / black | 6 |



Tischset Feinband „GLÄSER“
placemat fine band
mantelines
sets de tables



Motiv Gläser
 motive glass
 dibujo copas
 motif verres à pied

| | cm | | VE / Unit |
|---------|---------|--------------------------|-----------|
| 60514 5 | 45 x 33 | lemon-grün / lemon-green | 6 |

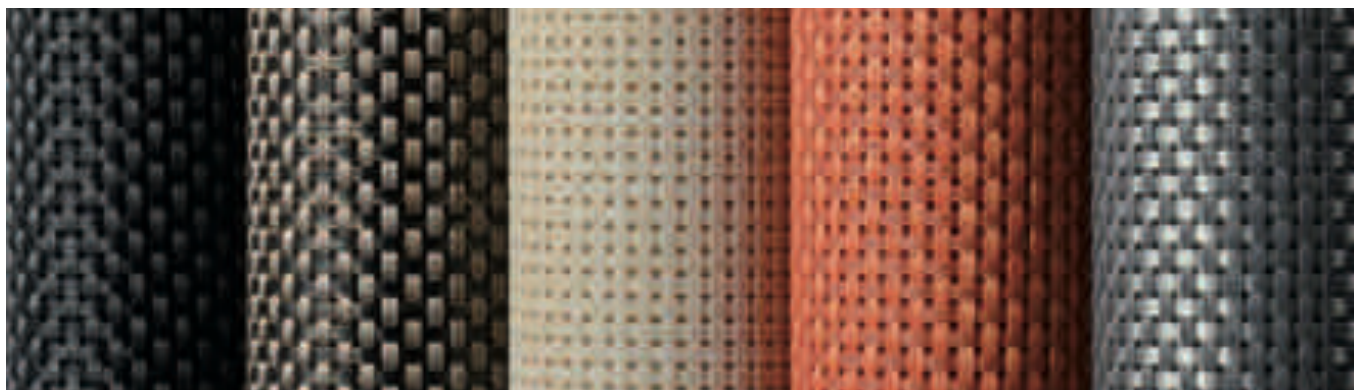

60022 - schwarz

60024 - beige, braun

60020 - beige

60021 - candyrot

60023 - silbergrau

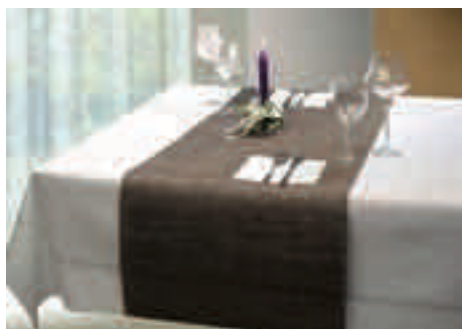

VE 1 / unit 1

Schmalband Tischläufer
table runner fine fabric
camino de mesa
chemins de table



pflegeleichtes Kunststoffgeflecht
 easy to clean
 fácil de limpiar
 nettoyage aisé

☐ cm

| | | | |
|-------|---|----------|-----------------------------|
| 60020 | 1 | 45 x 150 | beige / beige |
| 60021 | 8 | 45 x 150 | candyrot / candyred |
| 60022 | 5 | 45 x 150 | schwarz / black |
| 60023 | 2 | 45 x 150 | silbergrau / silver grey |
| 60024 | 9 | 45 x 150 | beige, braun / beige, brown |



Warenträger - Tischsets
display for table sets
expositor para mantelinas de mesa
présentoir pour sets de table



12 Einschubfächer, komplett auf Rollen, 2 Festrollen, Lieferung demontiert
 12 shelves, on rolls, 2 rolls to fix, delivery unassembled
 12 niveles, 4 ruedas, desmontado (montaje fácil)
 12 niveaux, 4 roues, livré démonté

☐ cm ↑ cm

| | | | |
|-------|---|-----------|-----|
| 00401 | 6 | 39,5 x 45 | 165 |
|-------|---|-----------|-----|

je Fach: 25 Stück Breitband
 oder 40 Stück Schmalband, Feinband

each shelf: 25 pcs. wide band
 or 40 pcs. small band, fine band

NEW

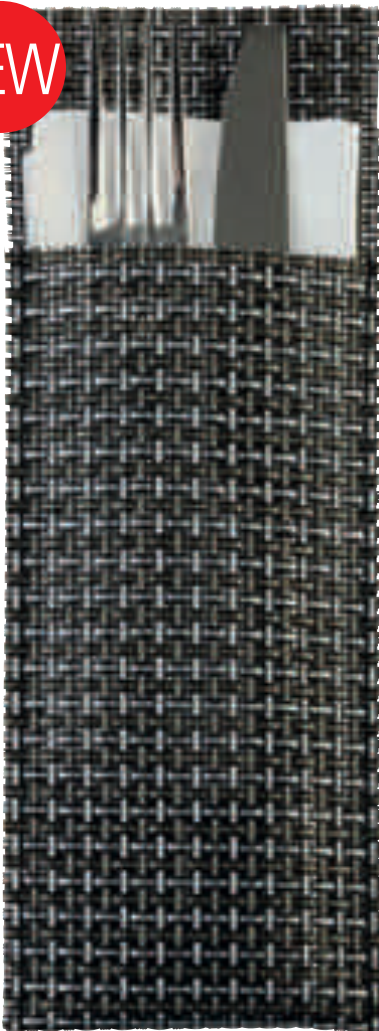

60551 silber/grau

Servietten- und Bestecktaschen, 6er Set
cutlery bag, 6 pcs.
bolsa cubiertos, 6 pz.
pochette couverts, 6 pc.



| | cm | | VE / Unit |
|---------|--------|-------------------------|-----------|
| 60550 3 | 24 x 9 | beige/beige | 6 |
| 60551 0 | 24 x 9 | silbergrau/silvergray | 6 |
| 60552 7 | 24 x 9 | beige braun/beige brown | 6 |
| 60553 4 | 24 x 9 | grün/green | 6 |
| 60554 1 | 24 x 9 | platin/platinum | 6 |

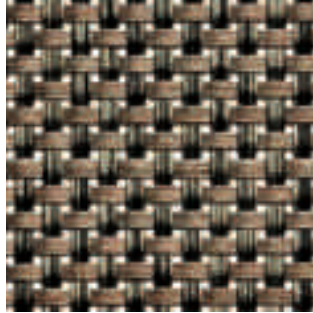

60552 beige/braun



60550 beige

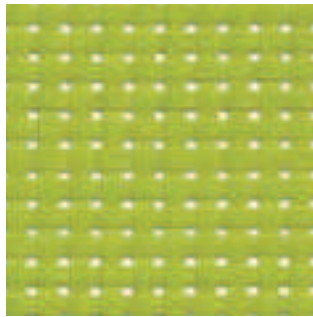

60553 grün

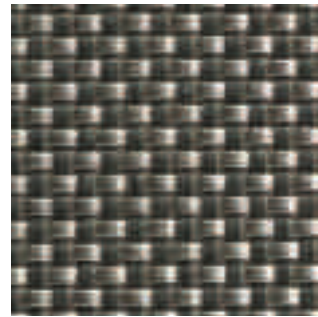

60554 platin



Table Caddy
table caddy
caddy de mesa
caddy de table

HOLZ
WOOD

| | cm | ↑ cm |
|---------|---------|------|
| 40405 2 | 25 x 15 | 18 |



designed by **KIRCHHOFF & EUWENS**

Pfeffer- und Salz-Menage „PROFI“
Pepper & Salt menage
Pimentero-salero
salière-poivrière



mit Edelstahl-Deckel
with stainless steel cover
con tapa de acero inoxidable
avec couvercle inox

| | □ cm | ↑ cm |
|---------|----------|------|
| 40420 5 | 9 x 4 | 15 |
| 40421 2 | 12,5 x 4 | 17 |



40420



40421

designed by **KIRCHHOFF & EUWENS**

Essig- und Öl-Menage „PROFI“
Vinegar & oil menage
set de aceite y vinagre
ménage huile et vinaigre



mit Edelstahl-Deckel, Kunststoff-Ausgießer
with stainless steel cover, plastic pourer
con tapa de acero inoxidable, pico vertedor de plástico
couvercle inox, bec verseur plastique

| | □ cm | ↑ cm |
|---------|------------|------|
| 40422 9 | 13,5 x 5,5 | 22 |
| 40423 6 | 13 x 13 | 22 |



40422
200 ml



40423

Kaffee . Körbe
coffee . basket



40430

Pfeffer- & Salz-Menage „FIVE STAR“
salt- & pepper-menage
salero-pimentero
ménage sel et poivre



matt poliert, Glasbehälter mit Edelstahl-Deckel und Drehverschluss
 satin polished finish, glass with stainless steel cover
 pulido acabado efecto satinado, cristal con tapa de acero inoxidable
 verre et inox mat satiné

| | □ cm | ↑ cm |
|---------|--------|------|
| 40430 4 | 10 x 5 | 14 |
| 40431 1 | Ø 10 | 14 |



40431



200 ml

40432

Essig- & Öl-Menage „FIVE STAR“
oil- & vinegar-Menage
aceitera-vinagrera
ménage huile et vinaigre



matt poliert, Glasbehälter mit Edelstahl-Deckel und tropffreiem Kunststoff-Ausgießer
 satin polished finish, glass with stainless steel cover
 pulido acabado efecto satinado, con tapa de acero inoxidable
 verre et inox mat satiné

| | □ cm | ↑ cm | Anzahl / Größe der Löcher |
|---------|--------|------|---------------------------|
| 40432 8 | 14 x 6 | 24 | |
| 40433 5 | Ø 14 | 24 | |

Einzelteile / spare parts / piezas sueltas / pièces détachées

Ersatzglas mit Deckel / spare glass with cover
 vidrio con tapa / verre + couvercle

| | | | |
|---------|-----|---|---------------------|
| 40311 6 | Ø 4 | 9 | 6 Löcher - Ø 1,85mm |
|---------|-----|---|---------------------|

Ersatzglas mit Deckel / spare glass with cover
 vidrio con tapa / verre + couvercle

| | | | |
|---------|-----|---|-----------------------|
| 40312 3 | Ø 4 | 9 | 18 Löcher - Ø 1,35 mm |
|---------|-----|---|-----------------------|

Ersatzglas mit Deckel „Essig & Öl“
 spare glass with cover „vinegar & oil“
 cristal de recambio con tapa „vinegar & oil“
 verre huile ou vinaigre avec couvercle inox et verseur anti-goutte

| | □ cm | ↑ cm | ltr. |
|---------|------|------|------|
| 40441 0 | Ø 6 | 18,5 | 0,2 |



40433

Ersatzglas mit Deckel „Zahnstocher“ / spare glass with cover „toothpick“
 porta-palillos vidrio con tapa / verre à cure-dents + couvercle

| | | | |
|---------|-----|---|--|
| 40313 0 | Ø 4 | 9 | |
|---------|-----|---|--|



Senftöpfchen, 2er Set
mustard glass, 2 pcs. set
juego 2 piezas vasos mostaza
jeu de 2 verres à moutarde



inkl. Löffel und Edelstahl-Deckel
 incl. spoons and covers
 incluye cucharas y tapas
 cuillères et couvercles inclus

| | □ cm | ↑ cm | pcs. |
|---------|------|------|------|
| 40415 1 | Ø 5 | 6 | 2 |



Menage „ECONOMIC“
menage
menage
ménage ECONOMIC



Glasbehälter mit Edelstahl-Deckel und Drehverschluss
 glass with stainless steel cover
 cristal con tapa inox a rosca
 en verre avec couvercle inox à visser

| | □ cm | ↑ cm |
|---------|-------|------|
| 40455 7 | 8 x 4 | 13 |
| 40457 1 | 8 x 8 | 12 |



Menage „ECONOMIC“
menage
menage
ménage ECONOMIC



Glasbehälter mit Edelstahl-Deckel und tropffreiem Kunststoff-Ausgießer
 glasses with stainless steel cover and non-drip nozzle-spout
 cristales con tapa de acero inoxidable y sistema antigoteo
 en verre avec couvercle inox et insert plastique anti-goutte

| | □ cm | ↑ cm |
|---------|------------|------|
| 40458 8 | 11,5 x 5,5 | 22 |
| 40460 1 | 11 x 10,5 | 22 |

Einzelteile / spare parts / piezas sueltas / pièces détachées

Pfeffer- oder Salz-Glasstreuer / pepper- or salt-glass with cover
 salero o pimentero de cristal con tapa / salière ou poivrière seule en verre avec couvercle inox
 40461 8

Essig- oder Öl-Glasbehälter / oil- or vinegar-glass with cover
 aceitera-vinagrera con tapa / bouteille huile ou vinaigre seule en verre et couv. Inox
 40462 5

Glas für Zahnstocher
 40463 2

Glas für Senf
 40464 9



40470

Menage „PRO“
menage
menage
ménage



matt poliert, Glasbehälter mit Edelstahl-Deckel und Drehverschluss

soporte 2 botellas

inox satinado, vidrio y tapas con rosca

inox poli mat satiné et verre, couvercle à visser

| | ☐ cm | ↑ cm |
|---------|-----------|------|
| 40470 0 | 8,5 x 5,7 | 11,5 |
| 40472 4 | 9,2 x 8,5 | 11,5 |
| 40474 8 | 10 x 10 | 11,5 |



40472



40474



40476

Menage „PRO“
menage
menage
ménage



matt poliert, Glasbehälter mit Edelstahl-Deckel und tropffreiem Kunststoff-Ausgießer

satin polished finish, glass with stainless steel cover and non-drip nozzle-spout

inox satinado, vidrio, sistema anti-goteo

inox poli mat satiné et verre, insert plastique anti-goutte

| | ☐ cm | ↑ cm |
|---------|-----------|------|
| 40476 2 | 12 x 8 | 19 |
| 40478 6 | 12,5 x 11 | 19 |
| 40480 9 | 13 x 11 | 19 |



40478

Einzelteile / spare parts / piezas sueltas / pièces détachées

Pfeffer- oder Salz-Glasstreuer / pepper- or salt-glass with cover

salero o pimentero de cristal con tapa / salière ou poivrière seule en verre avec couvercle inox

40461 8

Essig- oder Öl-Glasbehälter / oil- or vinegar-glass with cover

aceitera-vinagrera con tapa / bouteille huile ou vinaigre seule en verre et couv. Inox

40462 5



40480



40310



40320

Pfeffer- & Salz-Menage „CLASSIC“
salt- & pepper-menage
menaje 2 o 3 piezas
ménage 2 ou 3 pièces



Glasbehälter mit Edelstahl-Deckel und Drehverschluss

glass with stainless steel cover

vidrio con tapa de acero inoxidable à visser

en verre avec couvercle inox à visser

| | ☐ cm | ↑ cm |
|---------|------------|------|
| 40310 9 | 10,5 x 6,5 | 16 |
| 40320 8 | Ø 10,5 | 16 |



40440

Menage „CLASSIC“
menage
menage
ménage



Glasbehälter mit Edelstahl-Deckel und tropffreiem Kunststoff-Ausgießer

with stainless steel cover and non-drip nozzle-spout

vidrio con tapa inox y sistema antigoteo

verre avec couvercle inox et verseur anti-goutte

| | ☐ cm | ↑ cm | ltr. |
|---------|-------------|------|------|
| 40440 3 | 14,5 x 8,5 | 23 | 0,25 |
| 40450 2 | 17,5 x 10,5 | 23 | |

Einzelteile / spare parts / piezas sueltas / pièces détachées

Ersatzglas mit Deckel / spare glass with cover

vidrio con tapa / verre + couvercle

| | | | |
|---------|-----|---|---------------------|
| 40311 6 | Ø 4 | 9 | 6 Löcher - Ø 1,85mm |
|---------|-----|---|---------------------|

Ersatzglas mit Deckel / spare glass with cover

vidrio con tapa / verre + couvercle

| | | | |
|---------|-----|---|-----------------------|
| 40312 3 | Ø 4 | 9 | 18 Löcher - Ø 1,35 mm |
|---------|-----|---|-----------------------|

Ersatzglas mit Deckel „Essig & Öl“

spare glass with cover „vinegar & oil“

cristal de recambio con tapa „vinegar & oil“

verre huile ou vinaige avec couvercle inox et verseur anti-goutte

| | ☐ cm | ↑ cm | ltr. |
|---------|------|------|------|
| 40441 0 | Ø 6 | 18,5 | 0,2 |



40450

Ersatzglas mit Deckel „Zahnstocher“ / spare glass with cover „toothpick“

porta-palillos vidrio con tapa / verre à cure-dents + couvercle

| | | | |
|---------|-----|---|--|
| 40313 0 | Ø 4 | 9 | |
|---------|-----|---|--|



Parmesan-Menage „CLASSIC“
cheese dish
quesera
service à parmesan



hochglanzpoliert, inkl. Löffel
mirror polished finish, with spoon
pulido efecto espejo, con bol cristal y cuchara
brillant, avec bol verre et cuillère

| | | |
|---------|--------|------|
| | □ cm | ↑ cm |
| 40330 7 | Ø 10,5 | 7 |

Einzelteile / spare parts / piezas sueltas / pièces détachées

Ersatzbehälter / sparecontainer / repuesto del bol / bol de rechange

40331 4

designed by **KIRCHHOFF & EUWENS**

Parmesan-Menage „PROFI“
cheese dish
quesera parmesano
service à parmesan



inkl. Löffel

| | | |
|---------|------|------|
| | □ cm | ↑ cm |
| 40424 3 | Ø 9 | 5,5 |

Einzelteile / spare parts / piezas sueltas / pièces détachées

Ersatzbehälter / sparecontainer / repuesto del bol / bol de rechange

40331 4

Parmesan-Menage „PRO“
cheese dish
quesera
service à parmesan



inkl. Löffel



matt poliert, inkl. Löffel
satin polished finish, with spoon
pulido mate satinado, con bol cristal y cuchara
mat satiné, avec bol verre et cuillère

| | | |
|---------|--------|------|
| | □ cm | ↑ cm |
| 40482 3 | Ø 10,5 | 13 |

Einzelteile / spare parts / piezas sueltas / pièces détachées

Ersatzbehälter / sparecontainer / repuesto del bol / bol de rechange

40331 4



Parmesan-Menage „ECONOMIC“
cheese dish
quesera
service à parmesan



inkl. Löffel



inkl. Kunststofflöffel
with spoon
con cuchara
avec cuillère

| | | |
|---------|--------|------|
| | □ cm | ↑ cm |
| 40453 3 | Ø 10,5 | 7 |

Einzelteile / spare parts / piezas sueltas / pièces détachées

Ersatzbehälter / sparecontainer / rbol de recambio / bol de rechange

40454 0

**HOT
PRICE**



**Menage
menage
menage
ménage**



drehbares Gestell, Glasbehälter mit Edelstahl-Deckel und Drehverschluss
rotating frame, glasspieces with stainless steel cover
soporte giratorio con piezas de vidrio y tapas inox
tournant, avec pièces en verre et couvercle inox

| | | |
|---------|------|------|
| | ☐ cm | ↑ cm |
| 40485 4 | Ø 16 | 20 |



**Gewürz-Ständer
serving stand/rack
soporte salsas y condimentos
porte condiments et sauces**



matt poliert, Lieferung ohne Deko
satin polished finish
acabado pulido efecto satinado
poli mat satiné

| | | |
|---------|------|------|
| | ☐ cm | ↑ cm |
| 40300 0 | Ø 19 | 20 |

für 500 ml Flaschen



**Ständer
serving stand
soporte 2 botellas
support 2 bouteilles**



matt poliert, passend für handelsübliche 500 ml Flaschen, Lieferung ohne Flaschen
satin polished finish, for standard bottles with 500 ml content, delivery without bottles
inox satinado, para botellas estándar de 500ml, se entrega sin botellas
inox mat satiné, pour bouteilles standard de 500 ml, livré sans bouteilles

| | | |
|---------|------------|------|
| | ☐ cm | ↑ cm |
| 40444 1 | 14,5 x 8,5 | 35 |

für 250 ml Flaschen



**Ständer
serving stand
soporte 2 botellas
support 2 bouteilles**



hochglanzpoliert, passend für handelsübliche 250 ml Flaschen, Lieferung ohne Flaschen
mirror polished finish, for standard bottles with 250 ml content, delivery without bottles
inox satinado, para botellas estándar de 250ml, se entrega sin botellas
inox mat satiné, pour bouteilles standard de 250 ml, livré sans bouteilles

| | | |
|---------|--------|------|
| | ☐ cm | ↑ cm |
| 40443 4 | 13 x 7 | 30 |



150 ml

**Zuckerdosierer
sugar dispenser
azucarero
sucrier**



| | ☐ cm | ↑ cm | ltr. |
|---------|-------|------|------|
| 40490 8 | Ø 8,5 | 12 | 0,15 |

Einzelteile / spare parts / piezas sueltas / pièces détachées

Ersatzbehälter / spare-container / contenedor de repuesto / récipient verre de rechange

| | | | |
|---------|------------------------|--|--|
| 40498 4 | für / for / para 40490 | | |
|---------|------------------------|--|--|



150 ml

**Zuckerdosierer
sugar dispenser
azucarero
sucrier**



| | ☐ cm | ↑ cm | ltr. | € |
|-------|-------|------|------|------|
| 40494 | Ø 8,5 | 15 | 0,15 | 2,90 |

Einzelteile / spare parts / piezas sueltas / pièces détachées

Ersatzbehälter / spare-container / contenedor de repuesto / récipient verre de rechange

| | | | |
|---------|------------------------|--|--|
| 40499 1 | für / for / para 40494 | | |
|---------|------------------------|--|--|



00765
300 ml

**Allzweckgießer
pouer
bote vertedor universal
pot verseur universel**



| | ☐ cm | ↑ cm | |
|---------|-------|------|--|
| 00765 9 | Ø 8,5 | 13,5 | für Honig, Kaffeesahne, etc. for honey, cream, etc. para miel, crema. Etc pour le miel, le lait, la crème, etc. |
| 00766 6 | Ø 8,5 | 15 | zum Portionieren von Zucker for sugar para azúcar pour le sucre |

Einzelteile / spare parts / piezas sueltas / pièces détachées

Ersatzbehälter / spare-container / contenedor de repuesto / récipient verre de rechange

| | | | |
|---------|--|--|--|
| 00768 0 | | | |
|---------|--|--|--|



00766
300 ml

250 ml



Zuckerdosierer
sugar dispenser
azucarero
sucrier



Deckel und Dosier-Rohr aus Edelstahl
cover stainless steel
tapa inoxidable y tubo
couvercle inox et tube doseur

| | □ cm | ↑ cm | ltr. |
|---------|------|------|------|
| 40486 1 | Ø 8 | 15 | 0,25 |

250 ml



Allzweckgießer
pourer
dosificador
doseur



Deckel aus Edelstahl und Kunststoff
cover stainless steel and plastic
acero inoxidable / tapa plástico
couvercle en inox et plastique

| | □ cm | ↑ cm | ltr. |
|---------|------|------|------|
| 40488 5 | Ø 8 | 12,5 | 0,25 |

320 ml



Zuckerdosierer
sugar dispenser
azucarero
sucrier



Deckel mit Klappe aus Edelstahl
cover stainless steel
tapa acero inoxidable
couvercle inox

| | □ cm | ↑ cm | ltr. |
|---------|-------|------|------|
| 40487 8 | Ø 7,5 | 13,5 | 0,32 |

320 ml



Zuckerdosierer
sugar dispenser
azucarero
sucrier



Deckel mit Dosier-Rohr aus Edelstahl
cover stainless steel
tapa inoxidable y tubo
couvercle inoxydable et tube

| | □ cm | ↑ cm | ltr. |
|---------|-------|------|------|
| 40506 6 | Ø 7,5 | 17 | 0,32 |

GEWÜRZMÜHLEN PROFESSIONAL



Warenträger „Mühlen“
Art.-Nr. 00408 auf Anfrage



Salz-/ Pfeffermühlen gefertigt aus deutschem Buchenholz. Einfach gekennzeichnet durch S=Salz / P=Pfeffer an der Justierschraube. Die Pfeffermühlen haben ein Mahlwerk aus Carbon - scharfes und langlebiges Mahlwerk (Rockwellhärte 55) - Pfefferkörner werden erst „geschält“ anschließend „fein gemahlen“. Das Mahlwerk der Salzmühle eignet sich zum Mahlen von groben und trockenem Meersalz. Das Carbonstahl-Mahlwerk ist beständig gegen Korrosion.

Alle Mühlen werden ungefüllt geliefert.

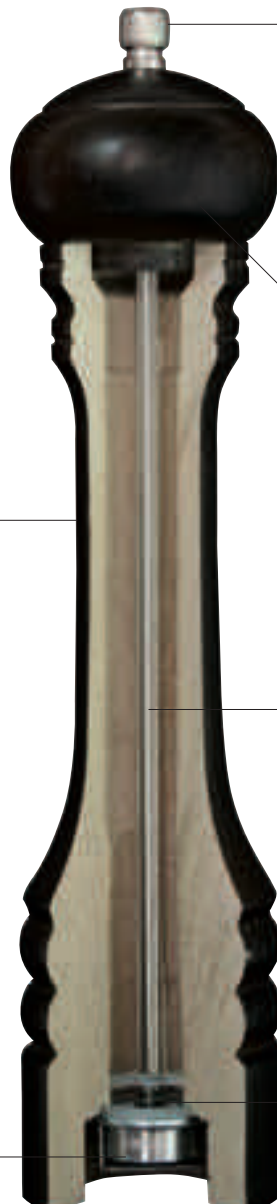
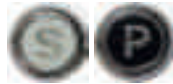

Mahlgrad einstellen:
feines Mahlen: Schraube im Uhrzeigersinn drehen
grobes Mahlen: Schraube entgegen dem Uhrzeigersinn drehen

Adjustment knob
Turn knob clockwise for finer grind, counter clockwise for coarser grind

Bouton d'ajustement
Tourner le bouton dans le sens antihoraire pour une mouture plus grosse

Mühlkopf:
um zu Mahlen, Mühlkopf im Uhrzeigersinn drehen

Pepper mill head
To grind, turn pepper mill head clockwise

Tête du moulin
Pour moudre, tourner la tête du moulin dans le sens horaire

Schaft:
Edelstahl Schaft
korrosionsfest

Shaft
Stainless steel shaft, corrosion resistant

Tige
- Tige en acier inoxydable
- Résistant à la corrosion

Federmechanismus:
gewährleistet ein konstantes Mahlergebnis

Spring loaded mechanism
Ensures a consistent grind selection

Mécanisme à ressort
Assure une mouture homogène

Verfügbare Ausführungen

- Deutsches Buchenholz in natur oder dunkel
- kristallklares Acryl

Finishes available

- German beechwood, in chocolate or natural finish
- crystal clear acrylic

Disponible en

- Bois massif de hêtre d'Allemande, finis espresso ou naturel
- Acier inoxydable
- Acrylique „Crystal“

Mahlwerk für Salz

hochwertiges, langlebiges Edelstahlmahlwerk

Mahlwerk für Pfeffer

Carbonstahl, eines der schärfsten und langlebigsten Mahlwerke auf dem Markt

Grinder for salt

High quality wear resistant stainless steel alloy

Grind for peppercorn

Carbon steel, the sharpest and most durable grinder on the market

Moulin à sel

Alliage d'acier inoxydable résistant à l'usure et à la corrosion

Moulin à poivre

Acier au carbone offre un affûtage plus durable et résistant à la corrosion



40530

40531

40532

40534



40520

40521

40522

40524



40540



40541



40542



Pfeffermühle „PROFESSIONAL“
pepper mill
molinillo de pimienta
moulin à poivre



| | □ cm | ↑ cm | | |
|---------|-------|------|---|-----------------|
| 40530 1 | Ø 5,5 | 15 | ● | Holz / wood |
| 40532 5 | Ø 7 | 30 | ● | Holz / wood |
| 40534 9 | Ø 7 | 40 | ● | Holz / wood |
| 40520 2 | Ø 5,5 | 15 | ● | Holz / wood |
| 40522 6 | Ø 7 | 30 | ● | Holz / wood |
| 40524 0 | Ø 7 | 40 | ● | Holz / wood |
| 40540 0 | Ø 5,5 | 15 | ● | Acryl / acrylic |



Salzmühle „PROFESSIONAL“
salt mill
molinillo de sal
moulin à sel

| | □ cm | ↑ cm | | |
|---------|-------|------|---|-----------------|
| 40531 8 | Ø 5,5 | 15 | ● | Holz / wood |
| 40521 9 | Ø 5,5 | 15 | ● | Holz / wood |
| 40541 7 | Ø 5,5 | 15 | ● | Acryl / acrylic |



40542

Chilimühle
chili mill
molinillo de chile
moulin à piment



| | □ cm | ↑ cm |
|---------|-------|------|
| 40542 4 | Ø 4,5 | 18,5 |

Salzmühle
40531Pfeffermühle
40530

Tablett
tray
bandeja
plateau



mit 2 Absätzen Ø 6 cm / with 2 holes Ø 6 cm
con 2 agujeros Ø 6 cm / avec 2 trous Ø 6 cm

| | □ cm | ↑ cm |
|---------|------------|------|
| 84039 3 | 16,5 x 8,5 | 1,5 |

Salzmühle
40541Pfeffermühle
40540

Naturschieferplatte / Untersetzer
natural slate tray
bandeja pizarra natural
plat ardoise naturelle



mit 2 Absätzen Ø 6 cm / with 2 holes Ø 6 cm / con 2 agujeros Ø 6 cm / avec 2 trous Ø 6 cm

| | □ cm | ✂ mm |
|---------|--------|-------|
| 00971 4 | 15 x 8 | 4 - 7 |

00971

EAN = 40 04 133 XXXX X

381

NEW



2 in 1 Salz- u. Pfeffermühle
2 in 1 salt / pepper mill
2 in 1 molinillo de sal / pimienta
2 in 1 moulin à poivre / sel

ACRYL ACRYLIC EDELSTAHL STAINLESS INOX

Keramik-Mahlwerk
ceramic mechanism
Molinillo de cerámica
Broyeur en céramique

| | cm | cm |
|---------|-------|------|
| 40545 5 | Ø 7,5 | 18,5 |



Mahlgrad einstellbar / grinder setting

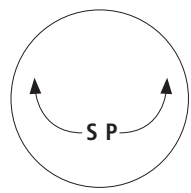

NEW



2 in 1 Salz- u. Pfeffermühle
2 in 1 salt / pepper mill
2 in 1 molinillo de sal / pimienta
2 in 1 moulin à poivre / sel

ACRYL ACRYLIC EDELSTAHL STAINLESS INOX

Keramik-Mahlwerk
ceramic mechanism
Molinillo de cerámica
Broyeur en céramique

| | cm | cm |
|---------|---------|-----|
| 40544 8 | 6 x 4,5 | 9,5 |



Mahlgrad einstellbar / grinder setting

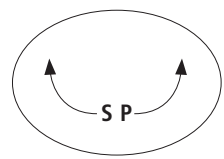

2 in 1 Salz- u. Pfeffermühle
2 in 1 salt / pepper mill
2 in 1 molinillo de sal / pimienta
2 in 1 moulin à poivre / sel

ACRYL ACRYLIC ABS KUNSTSTOFF

| | cm | cm |
|---------|-------|----|
| 40543 1 | 6 x 5 | 8 |

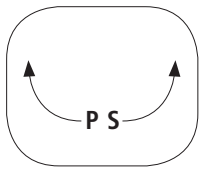

NEW



Multistreuer
multi-functional shaker
shaker



| | □ cm | ↑ cm | ltr. |
|---------|------|------|------|
| 00774 1 | Ø 7 | 12 | 0,20 |



NEW



Multistreuer
multi-functional shaker
shaker



| | □ cm | ↑ cm | ltr. |
|---------|------|------|------|
| 00773 4 | Ø 6 | 8 | 0,05 |



Käse- oder Gewürzstreuer
spice shaker
botes especieros
saupoudreurs à épices



inkl. Staubdeckel / incl. cover
agujeros Ø 5,5 mm + tapa plástica / trous Ø 5,5 mm + couvercle plastique

| | □ cm | ↑ cm | ltr. |
|---------|-------|------|------|
| 00775 8 | Ø 5,5 | 7,5 | 0,15 |

Netzstreuer / mesh top shaker
polvoreador, tapa con malla fina / pot à épices, couvercle toile fine

| | | | |
|---------|-------|-----|------|
| 00776 5 | Ø 5,5 | 7,5 | 0,15 |
|---------|-------|-----|------|

Streuer fein / small hole shaker
polvoreador, tapa con agujeros pequeños / pot à épices, couvercle à petits trous

| | | | |
|---------|-------|-----|------|
| 00777 2 | Ø 5,5 | 7,5 | 0,15 |
|---------|-------|-----|------|

Streuer grob / large hole shaker
polvoreador, tapa con agujeros grandes / pot à épices, couvercle à grands trous

| | | | |
|---------|-------|-----|------|
| 00778 9 | Ø 5,5 | 7,5 | 0,15 |
|---------|-------|-----|------|



40500



40501



40502

Salz- und Pfefferstreuer, 2er Set
salt - and pepper shaker, 2 pcs. set
juego de 2 piezas de sal y pimienta
set sel et poivre



Edelstahl-Deckel
 stainless steel cover
 tapa acero inoxidable
 couvercle inox

| | cm | cm | pcs. | |
|---------|-----|-----|------|---|
| 40500 4 | Ø 5 | 6,5 | 2 | glatte Ausführung / smooth version versión recta / forme lisse |
| 40501 1 | Ø 5 | 6,5 | 2 | geriffelte Ausführung / fluted version versión ondulada / forme ondulée |
| 40502 8 | Ø 5 | 6,5 | 2 | sternförmige Ausführung / star-shaped version versión estrellada / forme en étoile |



40504

40505

12er Set

Allzweckstreuer, 12er Set
shaker, 12 pcs set
juego 12 piezas dosificador
jeu de 12 salières/poivrières



| | cm | cm | pcs. | |
|---------|-------|----|------|------------------------------------|
| 40504 2 | 4 x 4 | 10 | 12 | 13 Löcher / 13 agujeros / 13 trous |
| 40505 9 | 4 x 4 | 10 | 12 | 3 Löcher / 3 agujeros / 3 trous |



40504
12er Set



40505
12er Set



14 g Inhalt

Ministreuer, 4er Set
smaller shaker, 4 pcs. Set
juego de 4 piezas bodegas pequeñas
jeu de 4 mini-salières



| | cm | cm | pcs. |
|---------|-------|----|------|
| 40503 5 | Ø 3,5 | 4 | 4 |



00779
Aluminium



00772
Edelstahl

Salzstreuer
salt cellar
salero
salière



Pommes-Frites Streuer mit Schraubkappe
 for french fries, cover to screw
 para patatas fritas, tapa de rosca
 pour les frites, couvercle à visser

| | cm | cm | |
|---------|-----|----|--|
| 00779 6 | Ø 8 | 17 | Aluminium / aluminium aluminio / aluminium |
| 00772 7 | Ø 8 | 17 | Edelstahl / stainless steel acero inoxidable / inox |

NEWin 3 Größen
erhältlich
Milch-/Universalkanne „ANTIHAFT“
non stick jug
jarra antiadherente
pichet anti-adhérent

PTFE-antihaftbeschichtet, perfekt für die Herstellung von Milchschaum
 PTFE coated, for baristas frothing hot milk
 revestimiento PTFE, ideal para espume de leche
 revêtement PTFE, idéal pour faire mousser le lait

| | □ cm | ↑ cm | ltr. |
|---------|--------|------|------|
| 10334 4 | Ø 8 | 10 | 0,35 |
| 10335 1 | Ø 9 | 11,5 | 0,6 |
| 10336 8 | Ø 10,5 | 13 | 0,8 |

in 5 Größen
erhältlich
Milch- / Universalkanne
milk / water jug
jarra leche/ agua
pichet à eau ou lait

außen hochglanzpoliert, innen matt poliert
 outside mirror polished finish, inside satin polished finish
 exterior brillante, interior satinado
 extérieur brillant, intérieur mat satiné

| | □ cm | ↑ cm | ltr. |
|---------|--------|------|------|
| 10328 3 | Ø 8 | 10 | 0,35 |
| 10329 0 | Ø 9 | 11,5 | 0,6 |
| 10330 6 | Ø 10,5 | 13 | 0,8 |
| 10331 3 | Ø 12 | 16,5 | 1,3 |
| 10332 0 | Ø 13,5 | 18 | 2 |

30054
1 Liter30055
2 Liter
Mess- / Universalkanne
graduated jug
jarra medidora universal
pichet mesureur universel

matt poliert, mit Maßskalierung innen
 satin polished finish, with stamped liter scale inner
 acabado satinado, con graduación en el interior
 mat, graduations à l'intérieur

| | □ cm | ↑ cm | ltr. |
|---------|------|------|------|
| 30054 5 | Ø 12 | 13 | 1 |
| 30056 9 | Ø 13 | 15 | 1,5 |
| 30055 2 | Ø 14 | 17 | 2 |

in 2 Größen
erhältlich
Messbecher
graduated jug
jarra graduada
pichet gradué

außen hochglanzpoliert, innen matt poliert, mit Maßskalierung außen
 outside mirror polished finish, inside satin polished finish, with stamped liter scale
 exterior pulido brillante, interior satinado con escalado en litros.
 extérieur brillant, intérieur satiné, graduation en litres

| | □ cm | ↑ cm | ltr. |
|---------|------|------|------|
| 30044 6 | Ø 8 | 11,5 | 0,5 |
| 30045 3 | Ø 10 | 14 | 1 |



Milch-Zucker Set
sugar-creamer-set
set para azúcar y crema
plateau avec sucrier et crémier



hochglanzpoliert, Sahnegießer, Zuckerdose, inkl. Löffel
 mirror polished finish, milk jug, sugar bowl, incl. spoon
 pulido brillante, con jarrita de leche, azucarero y cuchara
 brillant, avec crémier, sucrier et cuillère

| | ☐ cm | ↑ cm |
|---------|---------|------|
| 00635 5 | 15 x 11 | 6,5 |



10316
Zuckerspender

10317
Milchkännchen

Zuckerspender / Milchkännchen
sugar pourer / milk jug
dispensador de azúcar
sucrier doseur



matt poliert / satin polished finish / interior y exterior satinado / intérieur et extérieur poli mat

| | ☐ cm | ↑ cm | ltr. |
|---------|------|------|------|
| 10316 0 | Ø 5 | 15 | 0,17 |
| 10317 7 | Ø 5 | 11,5 | 0,17 |



Milchkännchen, 4er Set
milk/cream jugs, 4 pcs. set
pack de 4 jarritas para leche o crema
pack de 4 crémiers



hochglanzpoliert, für Kaffeesahne, mit Griff, Inhalt á 25 ml
 mirror polished finish, for coffee-cream, with handle, capacity á 25 ml
 pulido brillante para crema de café, con asa, capacidad 25 ml
 brillant, avec anse, 25 ml

| | ☐ cm | ↑ cm | pcs. |
|---------|-------|------|------|
| 10321 4 | Ø 3,6 | 3,5 | 4 |



10318
in 3 Größen
erhältlich

Milchkännchen / Sahnegießer
milk / cream jug
jarra de leche/ crema
pichet à eau ou lait



hochglanzpoliert / mirror polished finish / pulido brillante / brillant

| | ☐ cm | ↑ cm | ltr. |
|---------|-------|------|------|
| 10318 4 | Ø 4 | 4 | 0,05 |
| 10319 1 | Ø 4,8 | 5 | 0,09 |
| 10320 7 | Ø 6 | 6 | 0,15 |



Zucker-Kugel
sugar pot
azucarero
sucrier



hochglanzpoliert, mit Rolldeckel, Lieferung ohne Deko
mirror polished finish, rolltop cover
pulido acabado brillante, tapa abatible
brillant, couvercle abattant

| | | |
|---------|--------|------|
| | ☐ cm | ↑ cm |
| 00033 9 | Ø 13,5 | 15 |

für ca. 15 Zuckertüten



Zuckertüten-Box
sugar pocket holder
azucarero para bolsitas
porte-sachetsw de sucre



matt poliert, für ca. 15 Zuckertüten, Lieferung ohne Deko
satin polished finish, for ca. 15 sugar packets
acabado pulido efecto satinado, capacidad 15 sobrecillos
poli mat, pour 15 sachets

| | | |
|---------|---------|------|
| | ☐ cm | ↑ cm |
| 11579 8 | 9 x 7,5 | 5 |



Portionsspender
dispenser
dispensador para servicio bebidas calientes
présentoir pour station café



matt poliert, Spender für Milchportionen, Zuckertüten und Rührer, möbelschonende Unterseite, Lieferung ohne Deko
dispenser for condensed milk, sugar packs and stirrers, non-scratching undersurface
dispensador para leche condensada, sobres de azúcar, agitadores, base antiralladuras
idéal pour monodoses de crème ou lait, sucre en sachets longs, agitateurs. Base revêtue anti-rayures

| | | |
|---------|------|------|
| | ☐ cm | ↑ cm |
| 00073 5 | Ø 11 | 17,5 |



Milchportionsspender
milk dispenser
dispensador de monodoses de leche
présentoir pour monodoses de lait ou crème



matt poliert, für ca. 40 Milchportionen, Lieferung ohne Deko
satin polished finish, for approx. 40 points
pulido efecto satinado, para aproximadamente 40 dosis
poli mat, pour environ 40 monodoses. Livré sans décoration

| | | |
|---------|---------|------|
| | ☐ cm | ↑ cm |
| 00059 9 | 18 x 10 | 24 |



**Bialetti „Venus“
coffee maker Bialetti
cafetera Bialetti
cafetière Bialetti**



hochglänzend, Espresso-Kocher für 4 Tassen, geeignet für alle Herdarten, auch Induktion
mirror polished finish, coffee maker for 4 cups, suitable for all cookers, also for induction
cafetera Bialetti, 4 tazas, todas fuentes de calor incl. inducción, pulido brillante
cafetière Bialetti, 4 tasses, tous feux, y compris induction, brillant

| | ☐ cm | ↑ cm |
|---------|-------|------|
| 10342 9 | Ø 9,5 | 17,5 |



in 2 Größen erhältlich

**Bialetti „Moka-Express“
coffee maker Bialetti
cafetera Bialetti
cafetière Bialetti**



Espresso-Kanne, Aluminium-Legierung, „das Original“ Made in Italy
coffee maker, aluminium alloy „the original“ made in Italy
cafetera de aluminio, „la original“, hecha en Italia
cafetière aluminium, „laoriginale“, fabriquée en Italie

| | ☐ cm | ↑ cm | |
|---------|-------------|------|-------------------|
| 10338 2 | 16,5 x 16,5 | 16 | 3 Tassen / 3 cups |
| 10339 9 | 20 x 20 | 21 | 6 Tassen / 6 cups |



in 5 Größen
erhältlich

**Kaffeekanne
coffee pot
cafetera
pichet à café**



hochglanzpoliert, mit Klappdeckel
mirror polished finish, with hinged cover
acabado brillante, tapa con bisagra
poli brillant, couvercle à charnière

| | ☐ cm | ↑ cm | ltr. |
|---------|--------|------|------|
| 10323 8 | Ø 8 | 11,5 | 0,35 |
| 10322 1 | Ø 9 | 14 | 0,6 |
| 10325 2 | Ø 10,5 | 15,5 | 0,9 |
| 10326 9 | Ø 12 | 18,5 | 1,5 |
| 10327 6 | Ø 13,5 | 20 | 2 |

designed by **CULTURE FORM**



**Servierblech „KAFFEEHAUS“
tray
bandeja
plateau**



mattiert
30126 + 30127

hochglanzpoliert
30136 + 30137



| | ☐ cm | |
|---------|-------------|---|
| 30126 9 | 25,5 x 19,5 | mattiert / satin polished finish acabado efecto satinado / fini mat effet satin |
| 30127 6 | 30 x 23 | mattiert / satin polished finish acabado efecto satinado / fini mat effet satin |
| 30136 8 | 25,5 x 19,5 | hochglanzpoliert / mirror polished finish acabado espejo pulido / poli brillant miroir |
| 30137 5 | 30 x 23 | hochglanzpoliert / mirror polished finish acabado espejo pulido / poli brillant miroir |

NEW

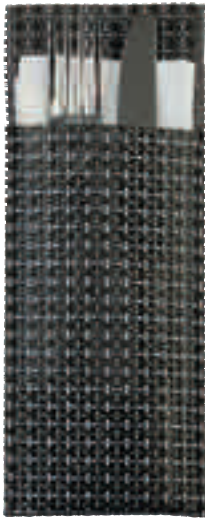

60551 silber/grau

Servietten- und Bestecktaschen, 6er Set
cutlery bag, 6 pcs.
bolsa cubiertos, 6 pz.
pochette couverts, 6 pc.



| | cm | | VE / Unit |
|---------|--------|-------------------------|-----------|
| 60550 0 | 24 x 9 | beige/beige | 6 |
| 60551 3 | 24 x 9 | silbergrau/silvergray | 6 |
| 60552 7 | 24 x 9 | beige braun/beige brown | 6 |
| 60553 4 | 24 x 9 | grün/green | 6 |
| 60554 1 | 24 x 9 | platin/platinum | 6 |

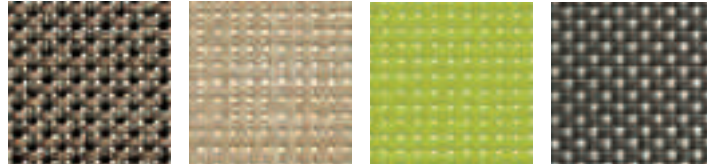

60552 beige/braun

60550 beige

60553 grün

60554 platin



Serviettenringe, 6er Set
napkin rings, 6 pcs. set
set de 6 aros servilleteros
set de 6 anneaux à serviettes



| | cm | cm | pcs. |
|---------|-----------|----|------|
| 04445 6 | 6,5 x 4,5 | 1 | 6 |



Serviettenringe, 4er Set
napkin rings, 4 pcs. set
4 servilleteros , set de 4 piezas
set de 4 anneaux porte-serviette



hochglanzpoliert
 mirror polished finish
 acero inoxidable
 inox

| | cm | cm | pcs. |
|---------|-------|-----|------|
| 04446 3 | Ø 4,7 | 2,5 | 4 |



Messerbänkchen, 6er Set
knife rest, 6 pcs. set
set 6 piezas, reposa cuchillos
set de 6 repose-couteaux



| | cm | cm | pcs. |
|---------|-------|-----|------|
| 04447 0 | 8 x 3 | 1,5 | 6 |



EAN = 40 04 133 XXXXX X

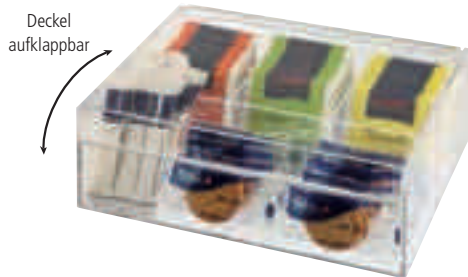

Teebox / Multibox
tea caddy
caja para te
boîte à thés et infusions

ACRYL
ACRYLIC

3 Fächer für kuvertierte Teebeutel, 1 Fach für Zucker, Kekse, etc., Deckel aufklappbar

4 chambers

4 compartimentos

4 compartiments

| | cm | cm | cm |
|---------|---------|----|----|
| 11563 7 | 22 x 17 | 9 | |



Teebox
tea-box
caja para te
boîte à thés et infusions

HOLZ
WOOD

Holzbox mit Sichtfenster, mit Aufschrift „Tee“, 4 Kammern können mit je 30 kuvertierten Teebeuteln bestückt werden, Deckel bleibt offen stehen

wooden box with clear transparent window, with inscription „Tee“, 4 chambers for approx. 30 tea bags

caja de madera clara con ventana transparente, con inscripción „Tee“, 4 compartimentos, para aproximadamente 30 bolsas de te

en bois clair avec fenêtre, marquée „TEE“, 4 compartiments, pour environ 30 sachets

| | cm | cm | cm |
|---------|-----------|----|----|
| 11575 0 | 33,5 x 20 | 9 | ● |
| 11574 3 | 33,5 x 20 | 9 | ● |



ohne Aufschrift

without inscription

sin inscripción

sans inscription

| | | | |
|---------|-----------|---|---|
| 11576 7 | 33,5 x 20 | 9 | ● |
|---------|-----------|---|---|



Teebox
tea-box
caja de te
boîte à thés et infusions

HOLZ
WOOD

Holzbox mit Sichtfenster, mit Aufschrift „Tee“, 12 Kammern können mit je 12 kuvertierten Teebeuteln bestückt werden, Deckel bleibt offen stehen

wooden box with clear transparent window, 12 chambers for approx. 144 tea bags

caja de madera clara con ventana transparente, con inscripción „Tee“, 12 compartimentos, para aproximadamente 144 bolsas de te

en bois clair avec fenêtre, marquée „TEE“, 12 compartiments, pour environ 144 sachets

| | cm | cm | cm |
|---------|---------|----|----|
| 11775 4 | 31 x 28 | 9 | ● |
| 11776 1 | 31 x 28 | 9 | ● |



designed by EsserDesign



Schale, 3-geteilt
bowl, 3-section
bol, 3 secciones
bol 3 compartiments



| | □ cm | ↑ cm |
|---------|------------|------|
| 83536 8 | 17,5 x 7,5 | 4,5 |



Teebeutel-Halter
tea bag caddy
porta bolsitas de te
présentoir pour sachets de thé



mit bis zu 15 Teebeuteln bestückbar
 up to max. 15 tea bags
 hasta 15 bolsitas de te
 maxi 15 sachets

| | □ cm | ↑ cm |
|---------|-----------|------|
| 11577 4 | 8,5 x 8,5 | 5 |



Teebeutel-Ablagen, 2er Set
tea bag rest, 2 pcs. set
set de dos platillos para bolsita de te
pack de 2 soucoupes pose-sachet



hochglanzpoliert
 mirror polished finish
 acabado pulido brillante
 brillant

| | □ cm | ↑ cm | pcs. |
|---------|----------|------|------|
| 11578 1 | 12,5 x 7 | 1 | 2 |



in 2 Größen erhältlich

Teebrühsieb
snap mesh tea ball
infusor de te, pinza con malla
boule à thé avec pinçe



matt poliert, mit feinem Sieb, aufklappbar
 satin polished finish, with fine mesh, hinged
 acabado pulido efecto satinado, con malla fina, con bisagra
 inox mat, maille fine, avec charnière

| | □ cm | → cm |
|---------|-------|------|
| 74750 0 | Ø 4,5 | 15,5 |
| 74751 7 | Ø 6,5 | 18 |



Zitronenschnitzelpresse
lemon slice squeezer
pinza exprimelimon
pince presse-citron



hochglanzpoliert, zum Auspressen von Zitronenscheiben
 mirror polished finish, to press lemon slices
 pulido brillante para rodajas de limón
 brillant, pour citrons en rondelle

| | □ cm |
|---------|-------|
| 71430 4 | 8 x 7 |

NEW



**Serviettenhalter
napkin holder
servilletero
porte-serviettes**



möbelschonende Unterseite, für ca. 30 Servietten, matt poliert
satin polished finish
acabado mate
poli mat satiné

| | | | |
|---------|----------|------|----------------|
| | cm | cm | |
| 11780 8 | 15 x 4,5 | 12,5 | for 30 napkins |



**Serviettenhalter
napkin holder
servilletero
porte-serviettes**



matt poliert
satin polished finish
acabado mate
poli mat satiné

| | | |
|---------|--------|----|
| | cm | cm |
| 11778 5 | 17 x 3 | 7 |



**Serviettenhalter
napkin holder
servilletero
porte-serviettes**



hochglanzpoliert
mirror polished finish
acabado pulido brillante
brillant, livré sans serviettes

| | | |
|---------|--------|----|
| | cm | cm |
| 11777 8 | 17 x 3 | 7 |



**Serviettenhalter
napkin holder
servilletero
porte-serviettes**



hochglanzpoliert, für Servietten mit 1/8 Falz, FüÙe mit rutsch- und kratzfester Gummierung
mirror polished finish, for napkins with 1/8 fold, rubber feet
acabado brillante para servilletas con plegado 1/8
brillant, pour serviettes avec pliage 1/8, livré sans serviettes

| | | |
|---------|-----------|------|
| | cm | cm |
| 11720 4 | 10 x 11,5 | 18,5 |



**Serviettenhalter „PROFI“
napkin holder, incl. weight
sujeta servilletas
porte-serviettes**

für 150 Servietten 1/4 Falz, inkl. Beschwerer, mit Antirutschfüßchen, absolut standfest
for 150 napkins 1/4 fold, anti-slip feet, very stable
para 150 servilletas de 1/4 plegado
pour 150 serviettes pliage 1/4

| | ☐ cm | ↑ cm |
|---------|-------------|------|
| 11766 2 | 18,5 x 18,5 | 18 |



11763



11765

**Serviettenhalter „WIRE“
napkin holder
servilletero
porte-serviettes**



für Servietten 1/4 Falz, inkl. Beschwerer
incl. pressure bar, with colour inlay
incluye barrita de contrapeso
barre de contrepoids incluse, acier chromé

| | ☐ cm | ↑ cm | |
|---------|---------|------|--|
| 11763 1 | 19 x 19 | 6,5 | für 50 Servietten for 50 napkins para 50 servilletas pour 50 serviettes |
| 11765 5 | 19 x 19 | 19 | für 150 Servietten for 150 napkins para 150 servilletas pour 150 serviettes |



**Serviettenhalter „BAR“
napkin folder
sujeta servilletas
porte-serviettes**



für ca. 50 Cocktailservietten, inkl. Beschwerer
for approx. 50 cocktail napkins, incl. weight
para aprox. 50 servilletas de aperitivo
pour environ 50 serviettes mini, barre de contrepoids incluse

| | ☐ cm | ↑ cm |
|---------|---------|------|
| 11762 4 | 14 x 14 | 6,5 |



**Serviettenhalter
napkin holder
servilletero
porte-serviettes**



matt poliert
satin polished finish
acabado satinado,
mat satiné

| | ☐ cm | ↑ cm |
|---------|---------|------|
| 11730 3 | 17 x 17 | 5 |

designed by **CULTURE FORM**



„bringen Sie
Ordnung auf
den Tisch“

Tisch Set „VARIO I“
table set
set de mesa
set de table



4-teilig: 1 Ständer + 1 Behälter (innen Ø 7 cm) für Tischreste + 2 Behälter (innen Ø 9 cm) für Besteck, Servietten etc., vielseitig einsetzbar

4 pcs. set: 1 stand + 1 table garbage bin (inner Ø 7 cm) + 2 bins (inner Ø 9 cm) for cutlery, napkins etc., versatile applicable

4piezas: à 1 soporte + 1 papelera Ø 7 cm de sobremesa + 2 recipientes Ø 9 cm para cubiertos, servilletas etc.

4 éléments: 1 support + 1 poubelle de table Ø 7 cm + 2 récipients Ø 9 cm pour couverts, serviettes, etc.

| | □ cm | ↑ cm |
|---------|---------|------|
| 11925 3 | 22 x 22 | 26 |

Einzelteile / spare parts / piezas sueltas / pièces détachées

Einzel-Behälter / only container / solo contenedor / recipient seul

| | | |
|---------|----------|----|
| 83998 4 | Ø 13 / 7 | 14 |
|---------|----------|----|

Einzel-Behälter / only container / solo contenedor / récipient seul

| | | |
|---------|----------|----|
| 83999 1 | Ø 13 / 9 | 14 |
|---------|----------|----|

designed by **CULTURE FORM**



Tisch Set „VARIO II“
table set
set de mesa
set de table



4-teilig: 1 Ständer + 3 Behälter (innen Ø 9 cm) für Besteck, Servietten etc., vielseitig einsetzbar

4 pcs. set: 1 stand + 3 bins (inner Ø 9 cm) for cutlery, napkins etc., versatile applicable

4 piezas: 1 soporte + 3 recipientes Ø 9 cm para cubiertos, servilletas etc

4 hauteurs: 1 support, 3 récipients int. 9 cm, pour couverts, serviettes,...

| | □ cm | ↑ cm |
|---------|---------|------|
| 11927 7 | 22 x 22 | 26 |

Einzelteile / spare parts / piezas sueltas / pièces détachées

Einzel-Behälter / only container / solo contenedor / recipient seul

| | | |
|---------|----------|----|
| 83998 4 | Ø 13 / 7 | 14 |
|---------|----------|----|

Einzel-Behälter / only container / solo contenedor / récipient seul

| | | |
|---------|----------|----|
| 83999 1 | Ø 13 / 9 | 14 |
|---------|----------|----|



83998



83999

designed by **CULTURE FORM**



Tischreste- / Besteckbehälter „TOP CHROM“
table waste bin / cutlery bin
papelera de sobremesa
poubelle de table



mit verchromten Rand
 with chrome plated ring
 con anillo cromado
 avec bord chromé

| | □ cm | ↑ cm | ltr. | |
|---------|------|------|------|---|
| 00025 4 | Ø 13 | 15 | 1 | ○ |
| 00026 1 | Ø 13 | 15 | 1 | ● |

designed by **CULTURE FORM**



Tischreste- / Besteckbehälter „BASE CHROM“
table waste bin / cutlery bin
papelera de sobremesa
poubelle de table



mit verchromten Boden
 with chrome bottom
 con base cromada
 avec base chromée

| | □ cm | ↑ cm | ltr. | |
|---------|------|------|------|---|
| 00019 3 | Ø 13 | 15 | 1,3 | ○ |
| 00020 9 | Ø 13 | 15 | 1,3 | ● |

Tischrestebehälter
table garbage bin
papelera de sobremesa
poubelle de table



matt poliert, abnehmbarer Schwingdeckel, mit Bajonettverschluss „fester Deckelsitz“
 satin polished finish, swing cover, cover removable
 acabado satinado, tapa basculante desmontable
 poli mat satiné, couvercle basculant démontable

| | □ cm | ↑ cm | ltr. |
|---------|------|------|------|
| 00029 2 | Ø 12 | 17 | 1,2 |
| 00027 8 | Ø 10 | 13 | 0,7 |

Tischreste- / Besteckbehälter
table garbage bin / cutlery bin
papelera de sobremesa
poubelle de table



matt poliert, mit abnehmbaren Lochdeckel
 satin polished finish, with removeable cover
 acabado pulido satinado, con tapa desmontable
 poli mat satiné, avec couvercle démontable ouvert au centre

| | □ cm | ↑ cm | ltr. |
|---------|------|------|------|
| 00028 5 | Ø 10 | 12 | 0,7 |



Tischrestbehälter
table garbage bin
papelera de sobremesa
poubelle de table



Behälter aus weiß lackiertem Metall, Edelstahl-Lochdeckel
 metall white, stainless cover with hole
 tapa, acero inoxidable, con apertura.
 couvercle inox< avec ouverture centrale, récipient en acier laqué blanc

| | ☐ cm | ↑ cm | ltr. |
|---------|------|------|------|
| 00292 0 | Ø 12 | 15 | 1,2 |

designed by **KIRCHHOFF & EUWENS**



Tischrestbehälter „SUNDAY“
table waste bin
papelera de sobremesa
poubelle de table



matt poliert, inkl. Deckel, fester Deckelsitz
 satin polished finish, incl. cover, cover removeable
 acero inoxidable mate, con tapa
 inox mat, avec couvercle

| | ☐ cm | ↑ cm | ltr. |
|---------|------|------|------|
| 00024 7 | Ø 10 | 18 | 1,1 |

designed by **KIRCHHOFF & EUWENS**



Tischrestbehälter „INTERNATIONAL“
table waste bin
papelera de sobremesa
poubelle de table



Deckel-Ring mit Dichtung, internationale Beschriftung
 cover with sealing ring
 tapa con junta, texto multi-idomas
 couvercle avec joint, texte multilingue

| | ☐ cm | ↑ cm | ltr. |
|---------|------|------|------|
| 83847 5 | 10 | 17,5 | 1 |



Tischrestbehälter
table garbage bin
papelera de sobremesa
poubelle de table



Behälter aus weiß lackiertem Metall, abnehmbarer Schwingdeckel
 cover stainless steel bin metal, white, swing cover
 tapa de acero inoxidable, recipiente chapa lacada blanca
 couvercle inox basculant, récipient en acier laqué blanc

| | ☐ cm | ↑ cm | ltr. |
|---------|------|------|------|
| 00291 3 | Ø 12 | 17 | 1,2 |

designed by **CULTURE FORM**



Tischreste- / Besteckbehälter / Universalbox
table waste bin / cutlery bin / box
papelera de sobremesa
poubelle de table



mit verchromten Rand
 with chrome plated ring
 con anillo cromado
 avec bord chromé

| | □ cm | ↑ cm | |
|---------|-------------|------|---|
| 00015 5 | 13,5 x 13,5 | 11 | ● |
| 00215 9 | 13,5 x 13,5 | 11 | ○ |



Tischreste- / Besteckbehälter / Universalbox
table waste bin / cutlery bin / box
papelera de sobremesa
poubelle de table



mit verchromten Rand, inkl. herausnehmbarem Einteiler (4 Fächer)
 with chrome plated ring, incl. divider (4 chambers)
 con anillo cromado
 avec bord chromé

| | □ cm | ↑ cm | |
|---------|---------|------|---|
| 00016 2 | 14 x 14 | 16 | ● |
| 00216 6 | 14 x 14 | 16 | ○ |

mit Antirutsch-Füßchen
 non-slip feet
 con pies antideslizantes
 avec pieds anti-dérapants



stapelbar
 stackable
 apilables
 empilable

designed by **EsserDesign**



Behälter stand
recipiente organizador
réceptif de table



| | □ cm | ↑ cm |
|---------|--------|------|
| 83537 5 | 10 x 4 | 6,5 |



Schale, 2-geteilt
bowl, 2-section
bol, 2 secciones
bol 2 compartiments



| | □ cm | ↑ cm |
|---------|------------|------|
| 83538 2 | 17,5 x 7,5 | 4,5 |



Schale, 3-geteilt
bowl, 3-section
bol, 3 secciones
bol 3 compartiments



| | □ cm | ↑ cm |
|---------|------------|------|
| 83536 8 | 17,5 x 7,5 | 4,5 |



Kaffee - Körbe
 coffee . basket

**HOT
PRICE**



Tischrestebehälter
table garbage bin
papelera de sobremesa
poubelle de table



| | ☐ cm | ↑ cm | litr. |
|---------|------|------|-------|
| 00311 8 | Ø 14 | 15 | 1,2 |
| 02038 2 | Ø 11 | 14 | 0,9 |

**HOT
PRICE**



mit Beschriftung

Tischrestebehälter
table garbage bin
papelera de sobremesa
poubelle de table



Kunststoff weiß / Granit, abnehmbarer Schwingdeckel
 white plastic, swing cover, cover removable
 plástico blanco/granito, tapa basculante desmontable
 plastique blanc/gris chiné, couvercle basculant démontable

| | ☐ cm | ↑ cm | litr. |
|---------|------|------|-------|
| 00031 5 | Ø 12 | 18 | 1,4 |

Tischkrümel-Entferner
crumber
recogemigas
ramasse-miettes



matt poliert, Hohlgriff
 satin polished finish, hollow handles
 acabado mate fácil de usar mango hueco
 mat satiné, manche creux, simple à utiliser

| | ☐ cm | → cm |
|---------|-----------|------|
| 00058 2 | 6,5 x 2,5 | 22 |

Tischkrümel-Entferner
crumber
recogemigas
ramasse-miettes



matt poliert, geschliffene Edelstahlkante lässt kein Körnchen zurück
 satin polished finish, no grain remains thanks to the flat grinded stainless steel edge
 acabado pulido mate , las migas se recogen fácilmente del mantel sin dejar restos gracias a su borde afilado
 mat satiné, ramasse facilement les miettes sur la nappe sans rien laisser grâce au rebord affilé

| | ☐ cm | ↑ cm |
|---------|----------|------|
| 00581 5 | 19 x 4,5 | 1 |

Original Turk-Qualität



schmiedeeiserne Servierpfanne wrought-iron pan sartén forjada poêle à friré forgée



mit zwei Griffen, hervorragende Brateigenschaft, Griffe und Stiele angeschweißt
with two welded handles, best bake properties, professional quality
con dos asas, excelentes propiedades de cocción, calidad profesional
2 anses, qualité professionnelle, excellente diffusion de chaleur, idéale pour la cuisson.

| | ☐ cm | ↑ cm | 📦 kg |
|---------|-----------|------|------|
| 73700 6 | Ø 14 - 20 | 3 | 0,87 |
| 73701 3 | Ø 17 - 24 | 3 | 1,15 |
| 73702 0 | Ø 21 - 28 | 3,5 | 1,49 |
| 73703 7 | Ø 24 - 32 | 3,5 | 1,85 |

Original Turk-Qualität



schmiedeeiserne Servierpfanne wrought-iron pan sartén forjada poêle à friré forgée



mit geschmiedetem, angeschweißtem Hakenstiel, hervorragende Brateigenschaft
welded handle with hook, best bake properties, professional quality
mango soldado, con gancho al final, excelentes propiedades culinarias, calidad profesional
manche soudé à accrocher, qualité professionnelle, excellente diffusion de chaleur, idéale pour la cuisson sur tous feux, pour le four ou pour la table

| | ☐ cm | ↑ cm | 📦 kg | |
|---------|-----------|------|------|------------------|
| 73710 5 | Ø 11 - 16 | 2 | 0,56 | |
| 73711 2 | Ø 14 - 20 | 3 | 0,85 | |
| 73712 9 | Ø 17 - 24 | 3 | 1,17 | |
| 73713 6 | Ø 21 - 28 | 3 | 1,53 | |
| 73714 3 | Ø 24 - 32 | 3 | 1,99 | |
| 73719 8 | Ø 21 - 28 | 4,5 | 1,72 | extra hoher Rand |

Original Turk-Qualität



schmiedeeiserne Servierpfanne wrought-iron pan sartén forjada poêle à friré forgée



mit geschmiedetem angeschweißtem gebogenem Hakenstiel, hervorragende Brateigenschaft
welded bended handle with hook, best bake properties, professional quality
con mango vuelto soldado, excelentes propiedades, calidad profesional
manche soudé replié, qualité professionnelle, excellente diffusion de chaleur

| | ☐ cm | ↑ cm | 📦 kg |
|---------|-----------|------|------|
| 73725 9 | Ø 14 - 20 | 3 | 0,87 |
| 73726 6 | Ø 17 - 24 | 3 | 1,18 |
| 73727 3 | Ø 21 - 28 | 3 | 1,54 |

Korkuntersetzer cork mat salvamanteles dessous-de-plat liège



ideal für Servier- und Eisenpfannen
ideal for iron pan
ideal para servir en sartenes de chapa
idéal pour présenter les poêles forgées sur table

| | ☐ cm | ↑ cm |
|---------|------|------|
| 73750 1 | Ø 24 | 2 |

Original Turk-Qualität



Eisenpfanne iron pan sartén de chapa poêle à frire lyonnaise



schwere Ausführung, mit angeschweißtem flachem Hakenstiel mit Öse, extra hoher Rand, für den professionellen Einsatz

heavy version, with flat welded handle with eye, extra high seam, professional quality

pesada, con mango plano, borde alto, para uso profesional

qualité lourde, manche plat, bord haut, pour usage professionnel

| | □ cm | ↑ cm | ⬆ kg |
|---------|-------------|------|------|
| 73739 6 | Ø 14,5 - 20 | 4 | 1,04 |
| 73740 2 | Ø 17 - 24 | 4 | 1,45 |
| 73741 9 | Ø 20,5 - 28 | 4,5 | 1,87 |
| 73742 6 | Ø 23 - 32 | 5 | 2,41 |
| 73743 3 | Ø 27 - 36 | 6 | 3,11 |
| 73744 0 | Ø 31 - 40 | 6 | 3,73 |

Original Turk-Qualität



Pizzaform pizza dish molde de pizza moule à pizza



Blaublech, nicht beschichtet, lange Lebensdauer, zum professionellen Pizzabacken

metal sheet, without coating, long endurance, baking pizza professional

chapa azul, sin revestimiento muy resistente, para uso profesional, larga duración

métal, sans revêtement, très résistant, pour usage professionnel, très durable

| | □ cm | ↑ cm |
|---------|-------------|------|
| 73500 2 | Ø 14 - 12,3 | 2,5 |
| 73501 9 | Ø 16 - 14,2 | 2,5 |
| 73502 6 | Ø 18 - 16,2 | 2,5 |
| 73503 3 | Ø 20 - 18,2 | 2,5 |
| 73504 0 | Ø 22 - 20,2 | 2,5 |
| 73505 7 | Ø 24 - 22,3 | 2,5 |
| 73506 4 | Ø 26 - 24,3 | 2,5 |
| 73507 1 | Ø 28 - 26,3 | 2,5 |
| 73508 8 | Ø 30 - 28,3 | 2,5 |
| 73509 5 | Ø 32 - 30,3 | 2,5 |
| 73510 1 | Ø 36 - 34,3 | 2,5 |
| 73511 8 | Ø 40 - 38,3 | 2,5 |
| 73512 5 | Ø 45 - 42,3 | 2,5 |
| 73513 2 | Ø 50 - 48,4 | 2,5 |

hitzebeständig bis 600°C



hitzebeständig bis 300°C

Pizzaform pizza dish molde de pizza moule à pizza



Blaublech, rechteckig, Rand umgelegt, hitzebeständig bis 300°C

blue steel baking sheet, rectangular

chapa azul rectangular, borde plgado

métal, rectangulaire, rectangular, bord plié

| | □ cm | ↑ cm |
|---------|---------|------|
| 88255 3 | 50 x 35 | 2,5 |
| 88256 0 | 60 x 40 | 2,5 |



**Back- / Frittierlöffel
skimmer / spider
espumadera para fritos
écumoire à friture**

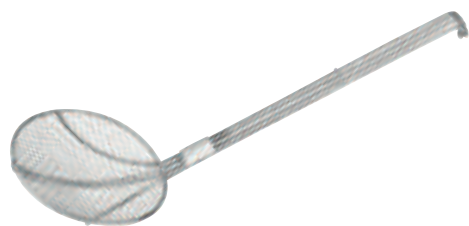

elektropoliert, sehr stabile Ausführung
electro polished, heavy gauge
electro pulido, alta calidad
poli électrolythique, qualité extra

| | cm | → cm |
|---------|------|------|
| 74400 4 | Ø 10 | 32,5 |
| 74401 1 | Ø 12 | 43,5 |
| 74402 8 | Ø 16 | 42,5 |
| 74403 5 | Ø 18 | 42,5 |
| 74404 2 | Ø 20 | 51 |



**Nestbacklöffel
birds nest fryer
espumadera de malla
écumoire toile métallique**



in 2 Größen Lieferbar

elektropoliert, 2-teilig
electro polished, 2 pcs.
pulido por electrolisis, 2 piezas
poli électrolythique, 2 pièces (avec soudure)

| | cm | → cm |
|---------|----------|------|
| 88616 2 | Ø 6 - 8 | 25,5 |
| 88615 5 | Ø 8 - 10 | 26,5 |



**Gazespitzsieb
conical strainer with wire gauze
colador chino de malla
chinois renforcé avec maille fine**



hochglanzpoliert, mit rundem Hohlgriff, ca. 9 Löcher pro 1 cm²
mirror polished finish, 9 holes per 1 cm²
pulido acabado brillante, mango hueco, 9 agujeros por 1 cm²
brillant, manche creux, 9 trous pour 1 cm²

| | cm | → cm |
|---------|------|------|
| 88718 3 | Ø 20 | 25 |
| 88717 6 | Ø 24 | 25 |



**Spitzsieb
conical strainer
colador cónico
chinois**



mit Lochung Ø 1,5 mm, auch in der Kegelspitze, mit Flachstiel, mit Stützstiel zum Einhängen in den Topfrand

with Ø 1,5 mm holes (including the tip), with flat handle, with supporting hook
con agujeros finos de Ø 1,5 mm (incluida la punta), con mango plano y gancho
perforations fines 1,5 y compris à la pointe, manche plat et crochet

| | cm | ↑ cm | → cm |
|---------|-------------|------|------|
| 00770 3 | Ø 19,5 / 18 | 14 | 16 |
| 00771 0 | Ø 23,5 / 22 | 18 | 16 |

**Passiersieb
strainer
colador
passoire**



feines Siebgewebe mit ca. 6 Löchern pro 1 cm²

fine mesh with 6 holes per 1 cm²

malla fina con 6 agujeros por 1 cm²

toile fine avec 6 trous pour 1 cm²



| | ☐ cm | ↑ cm | → cm |
|---------|------|------|------|
| 88621 6 | Ø 22 | 8 | 28 |
| 88617 9 | Ø 26 | 12 | 28 |
| 88618 6 | Ø 30 | 12 | 28 |
| 88619 3 | Ø 34 | 20 | 28 |

**Passiersieb
strainer
colador
passette**



feines Siebgewebe mit ca. 6 Löchern pro 1 cm²

fine mesh with 6 holes per 1 cm²

malla fina con 6 agujeros por 1 cm²

toile fine avec 6 trous pour 1 cm²



| | ☐ cm | → cm | ltr. |
|---------|------|------|------|
| 74698 5 | Ø 10 | 14,5 | 0,15 |
| 74699 2 | Ø 12 | 14,5 | 0,25 |
| 74700 5 | Ø 14 | 16 | 0,4 |
| 74701 2 | Ø 16 | 16 | 0,7 |
| 74702 9 | Ø 18 | 16 | 1 |
| 74703 6 | Ø 20 | 16 | 1,5 |
| 74704 3 | Ø 22 | 17 | 2,0 |
| 74705 0 | Ø 24 | 17 | 2,5 |
| 74706 7 | Ø 26 | 17 | 3,0 |

**Passiersieb
strainer
colador
passette**



mit Doppelnetz, Netz außen: ca. 2 Löcher pro 1 cm, Netz innen: ca. 5 Löcher pro 1 cm, Netz außen: ca. 2 Löcher pro 1 cm, Netz innen: ca. 5 Löcher pro 1 cm

with double mesh, outer mesh about 2 holes per cm, inner mesh about 5 holes per cm

con malla doble, malla exterior aprox. 2 agujeros /cm, interior aprox. 5 agujeros /cm

avec double étamine, extérieure env. 2 trous/cm, intérieure environ 5 trous/cm

Doppelnetz
double mesh



| | ☐ cm | → cm |
|---------|------|------|
| 74721 0 | 20 | 18 |
| 74722 7 | 23 | 27,5 |

**Pommes-Frites-Seiher
fry dripping tray
escurridor de fritos
égouttoir à friture**



herausnehmbarer Locheinsatz, mit Handgriff

removable drainer, with handle

fondo de colador desmontable

fond démontable



| | ☐ cm | ↑ cm |
|---------|------|------|
| 00785 7 | Ø 39 | 19 |



Netzbackschaufel
chip shovel
pala rectangular
pelle à friture rectangulaire



elektropoliert, Lochmaß 6 x 6 mm, schwere Ausführung
 electro polished, holze size 6 x 6 mm, heavy gauge
 electro pulido, agujeros de 6x6, calidad extra
 poli électrolythique, trous de 6 x 6 mm, qualité extra

| | □ cm | → cm |
|---------|---------|------|
| 88633 9 | 21 x 17 | 21 |



Passiermühle
moulin / sieve
molino de grosellas
presse-groseilles



Rolle Buchen-Holz versiegelt, ca. 10 Löcher pro 1 cm²
 wood-piece beech, 10 holes per 1 cm²
 bola ovalada de haya, 10 agujeros por 1 cm²
 boule ovale en hêtre, 10 trous pour 1 cm²

| | □ cm | ↑ cm | → cm |
|---------|------|------|------|
| 88607 0 | Ø 20 | 10 | 19 |



Suppensieb
strainer
colador
passoire



hochglanzpoliert, Lochung 3 mm, mit Drahtgriff Ø 5 mm, für Töpfe Ø 26 - 28 cm
 mirror polished finish, holes 3 mm, with wire handle Ø 5 mm, for pots Ø 26 - 28 cm
 pulido brillante, agujeros 3 mm, con mango varilla 5 mm, para cacerolas de 26- 28 cm
 brillant, trous dia. 3 vmm, manche fil diam. 5 mm, pour casseroles de 26 à 27 cm

| | □ cm | ↑ cm | → cm | ltr. |
|---------|------|------|------|------|
| 74730 2 | Ø 24 | 12 | 15 | 3,5 |



Wasserbadschüssel
bain marie bailing bowl
cazo para baño maria
réceptien bain-marie

in 3 Größen lieferbar



hochglanzpoliert, mit Drahtgriff Ø 5 mm
 mirror polished finish, with wire handle Ø 5 mm
 inox pulido brillante mango varilla 5 mm
 inox brillant, manche fil épaisseur 5 mm

| | □ cm | ↑ cm | → cm | ltr. |
|---------|--|------|------|------|
| 74731 9 | Ø 18 | 9 | 15 | 1,5 |
| | für Töpfe Ø 20 - 26 cm / for pots Ø 20 - 26 cm para cacerolas Ø 20 - 26 cm / pour casseroles Ø 20 - 26 cm | | | |
| 74732 6 | Ø 20 | 10 | 15 | 2.0 |
| | für Töpfe Ø 24 - 28 cm / for pots Ø 24 - 28 cm para cacerolas Ø 24 - 28 cm / pour casseroles Ø 24 - 28 cm | | | |
| 74733 3 | Ø 24 | 12 | 15 | 3,5 |
| | für Töpfe Ø 26 - 28 cm / for pots Ø 26 - 28 cm para cacerolas Ø 26 - 28 cm / pour casseroles Ø 26 - 28 cm | | | |



Messbecher
measuring cup
jarra graduada
pichet gradué



mit geschlossenem Griff, mit geprägter Maßskalierung außen, Liter- und Milli-Liter-Einteilung
 with handle, with stamped printed liter and ml scale
 con asa, graduación ml.
 avec anse, graduation en ml.

| | ☐ cm | ↑ cm | ltr. |
|---------|--------|------|------|
| 30046 0 | Ø 9,5 | 14 | 0,5 |
| 30047 7 | Ø 12 | 17 | 1 |
| 30048 4 | Ø 15,5 | 21 | 2 |
| 30049 1 | Ø 17,5 | 23,5 | 3 |
| 30057 6 | Ø 20,5 | 27,5 | 5 |



in 2 Größen
 lieferbar

Messbecher
graduated jug
jarra graduada
pichet gradué



außen hochglanzpoliert, innen matt poliert, mit Maßskalierung außen
 outside mirror polished finish, inside satin polished finish, with stamped liter scale
 exterior pulido brillante, interior satinado con escalado en litros.
 extérieur brillant, intérieur satiné, graduation en litres

| | ☐ cm | ↑ cm | ltr. |
|---------|------|------|------|
| 30044 6 | Ø 8 | 11,5 | 0,5 |
| 30045 3 | Ø 10 | 14 | 1 |



30054
 1 ltr.

30055
 2 ltr.

Mess- / Universalkanne
graduated jug
jarra medidora universal
pichet mesureur universel



matt poliert, mit Maßskalierung innen
 satin polished finish, with stamped liter scale inner
 acabado satinado, con graduación en el interior
 mat, graduations à l'intérieur

| | ☐ cm | ↑ cm | ltr. |
|---------|------|------|------|
| 30054 5 | Ø 12 | 13 | 1 |
| 30056 9 | Ø 13 | 15 | 1,5 |
| 30055 2 | Ø 14 | 17 | 2 |



Kännchen für Olivenöl
olive-oil can
aceitera
verseuse à huile



| | ☐ cm | ↑ cm | ltr. |
|---------|----------|------|------|
| 40305 5 | 22 x 6,8 | 17 | 0,5 |



Schaumspesering
mousse ring
aro redondo para semifríos
cercle à mousse rond



matt poliert, fugenlos
 satin polished finish, seamless
 acabado satinado sin soldadura
 mat satiné, sans soudure

| | □ cm | ↑ cm |
|---------|------|------|
| 00098 8 | Ø 6 | 4,5 |
| 00099 5 | Ø 7 | 4,5 |
| 00092 6 | Ø 8 | 4,5 |
| 00093 3 | Ø 10 | 4,5 |
| 00094 0 | Ø 12 | 4,5 |
| 00095 7 | Ø 14 | 5 |



Schaumspeseform
mousse mould
aro cuadrado para semifríos
cercle à mousse carré



matt poliert, fugenlos
 satin polished finish, seamless
 acabado satinado sin soldadura
 mat satiné, sans soudure

| | □ cm | ↑ cm |
|---------|-------|------|
| 00096 4 | 6 x 6 | 4,5 |
| 00097 1 | 8 x 8 | 4,5 |



Schaumspeseringe, 5er Set
mousse ring, 5 pcs. set
juego aros para emplatar o para semifríos
jeu de cercles à mousse inox, ronds



5-teilig: 4 Formen + 1 Verdichter, matt poliert, fugenlos
 5 pcs. set: 4 shapes and 1 pusher, satin polished finish, seamless
 juego de 5 piezas: 4 aros redondos y 1 pulsador, para dar forma, satinado sin soldadura
 jeu de 5 pièces: 4 cercles et 1 poussoir. Idéal pour dressage sur assiette ou mousse. Mat satiné, sans soudure

| | □ cm | ↑ cm |
|---------|------|------|
| 00110 7 | Ø 6 | 4,5 |
| 00113 8 | Ø 8 | 4,5 |
| 00114 5 | Ø 10 | 4,5 |



Schaumspeseform Herz
mousse mould heart
molde „corazón“ para semifríos
cercle à mousse „coeur“



matt poliert, fugenlos
 satin polished finish, seamless
 acabado satinado sin soldadura
 mat satiné, sans soudure

| | □ cm | ↑ cm |
|---------|-------|------|
| 00116 9 | 8 x 9 | 4,5 |



Pastetenform mit Deckel
pastry mould with lid
molde para paté con tapa
moule à terrine avec couvercle



für Pasteten und Terrinen
 for pasties and terrines
 para patés y tarrinas
 terrines

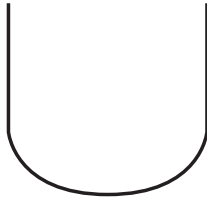

Terrinen- / Parfaitform
terrine / yule log mould
molde tarrina redonda
moule à terrine arrondi



| | □ cm | → cm | ltr. |
|---------|---------|------|------|
| 88906 4 | 7,5 x 7 | 18 | 0,8 |
| 88907 1 | 7,5 x 7 | 23 | 1 |
| 88908 8 | 7,5 x 7 | 28 | 1,25 |
| 88909 5 | 7,5 x 7 | 38 | 1,75 |

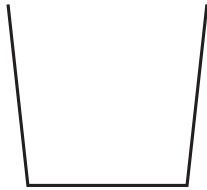

Pastetenform
terrine mould
molde tarrina ángulos rectos
moule à terrine évasé



| | □ cm | → cm | ltr. |
|---------|-------|------|------|
| 88122 8 | 7 x 8 | 30 | 1,6 |

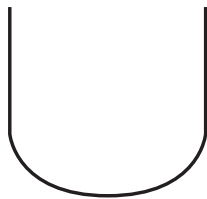

Pastetenform
terrine mould
molde tarrina redonda
moule à terrine arrondi



| | □ cm | → cm | ltr. |
|---------|---------|------|------|
| 88123 5 | 5,5 x 5 | 27,5 | 0,5 |

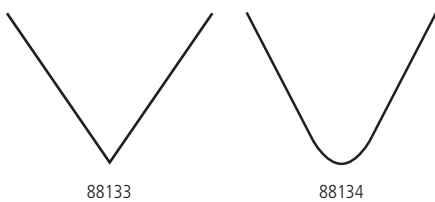

Pastetenform
terrine mould
molde tarrina triangular
moule à terrine triangulaire



| | □ cm | → cm | ltr. |
|---------|---------|------|------|
| 88133 4 | 8 x 7,5 | 26 | 0,7 |
| 88134 1 | 8 x 7,5 | 26 | 0,7 |



200 ml
 ideale Größe für
 Panna cotta



in 4 Größen
 erhältlich

Dariolformen, 2er Set
dairol moulds, 2 pcs. set
juego 2 flaneras
jeu de 2 moules à flan



hochglanzpoliert
 mirror polished finish
 acabado brillante
 brillant

| | □ cm | ↑ cm | ltr. |
|---------|-------|------|-------|
| 00105 3 | Ø 5,6 | 4,7 | 0,075 |
| 00106 0 | Ø 6,3 | 4,5 | 0,1 |
| 00107 7 | Ø 7,0 | 3,5 | 0,1 |
| 00108 4 | Ø 8,5 | 5,0 | 0,2 |



**Dosierspender
dispenser
dispensador de salsa
doseur à sauce**



| | □ cm | ↑ cm | ltr. |
|---------|----------|------|------|
| 93150 3 | Ø 11 | 27 | 1,35 |
| 93151 0 | 13 x 7,5 | 27 | 1,25 |

93150
1,35 ltr.

93151
1,25 ltr.

88271

**Dosierpumpe
dosing pump / riser tube
bomba de salsa, sola
pompe à sauce**



Hubvolumen 30 ml / swept volume 30 ml / cada dosis 30 ml / 30 ml par dose

| | | |
|---------|-------|----|
| 88271 3 | Ø 4,5 | 40 |
|---------|-------|----|



glasklar



eisblau

4 - 8 - 14
Liter / liters

**Schüssel
bowl
ensaladera
saladier**



| | □ cm | ↑ cm | ltr. | |
|---------|--------|------|------|---|
| 30260 0 | Ø 32,5 | 10 | 4 | ○ |
| 30263 1 | Ø 40 | 12 | 8 | ○ |
| 30266 2 | Ø 47 | 14,5 | 14 | ○ |
| 30261 7 | Ø 32,5 | 10 | 4 | ● |
| 30264 8 | Ø 40 | 12 | 8 | ● |
| 30267 9 | Ø 47 | 14,5 | 14 | ● |

**Salatschleuder „XXL“
salad spinner
escurreverduras
essoreuse à salade**



ideal um größere Mengen Gemüse, Früchte oder Salat nach dem Waschen zu trocknen, inkl. Ablaufschlauch

ideal for drying large amounts and fruits after washing, removable inner basket with crank handle

ideal para escurrir gran cantidad de frutas y verduras después del lavado, cesta interior desmontable

idéale pour essorer une grande quantité de salade ou légumes après leur lavage, panier intérieur

| | □ cm | ↑ cm | ltr. |
|---------|------|------|------|
| 88733 6 | Ø 43 | 52 | 25 |



**Seiher
strainer
colador
passoire**



mit 2 Muschelgriffen
with 2 shell shaped grips
con dos asas
à 2 anses moulées

| | □ cm | ↑ cm |
|---------|------|------|
| 00780 2 | Ø 36 | 19 |



Likör- und Fondantrichter
confectionery funnel
embudo dosificador
entonnoir à piston



ergonomischer Griff aus Kunststoff, mit 3 Düsen 2, 4 und 6 mm, inkl. Ständer und Auffangschale

ergonomic plastic handle, with 3 different nozzles 2, 4 and 6 mm, incl. wire rack and dripping dash

mango ergonómico de plástico con 3 boquillas, 2, 4 y 6 mm, incluido pie de alambre y bandeja recoge gotas

manche plastique ergonomique, 3 douilles de 2, 4 et 6 mm, inclut pied avec ramasse-gouttes

| | ☐ cm | ↑ cm | litr. |
|---------|------|------|-------|
| 77338 7 | Ø 20 | 34 | 1,5 |



Nudelmaschine
pasta machine
máquina de pasta
machine à pâtes



7 Nudeldicken einstellbar

adjustable steel rollers for kneading, 7 thickness settings

rodillos de acero ajustables para laminar hasta 7 grosores

rouleaux réglables, 7 épaisseurs possibles

| | ☐ cm | ↑ cm |
|---------|---------|------|
| 50001 3 | 24 x 21 | 15 |



mit 7 verschiedenen Klingen

Gemüsehobel, Mandoline
mandolin
mandolina
mandoline



mit 7 verschiedenen Klingen, Anti-Rutsch-Gestell, Schutzabdeckung, Klingbreite 10 cm

with 7 interchangeable blades, non-slip folding stand, safety guard, blade width 10 cm

con 7 cuchillas intercambiables, pie plegable anti-deslizante, carro de seguridad. Anchura de corte 10 cm

7 peignes interchangeables, pied repliable anti-glisse, chariot, largeur de coupe 10 cm

| | ☐ cm | ↑ cm |
|---------|-----------|--------|
| 88688 9 | 40,5 x 12 | 5 / 25 |





93222 1,1 ltr. 93223 1,1 ltr. 93224 1,1 ltr.

mit Verschlusskappe

**Quetschflasche
squeeze bottle
bote dosificador flexible
bouteille verseuse souple**



| | □ cm | ↑ cm | ltr. | |
|---------|-------|------|------|---|
| 93222 7 | Ø 9,5 | 25,5 | 1,1 | ● |
| 93223 4 | Ø 9,5 | 25,5 | 1,1 | ● |
| 93224 1 | Ø 9,5 | 25,5 | 1,1 | ● |



93240 0,35 ltr. 93241 0,35 ltr. 93245 0,7 ltr.

| | □ cm | ↑ cm | ltr. | |
|---------|------|------|------|---|
| 93240 1 | Ø 7 | 21 | 0,35 | ● |
| 93241 8 | Ø 7 | 21 | 0,35 | ● |
| 93242 5 | Ø 7 | 21 | 0,35 | ○ |
| 93243 2 | Ø 8 | 24,5 | 0,7 | ● |
| 93244 9 | Ø 8 | 24,5 | 0,7 | ● |
| 93245 6 | Ø 8 | 24,5 | 0,7 | ○ |



200 ml

**Quetschflasche
squeeze bottle
bote dosificador flexible
bouteille verseuse souple**



ideale Größe um Speiseteller mit Saucen zu verzieren, mit Verschlusskappe
ideal size to garnish plates with sauces, with cap
tamaño ideal para decorar los platos con salsas o culis. Con tapón
taille idéale pour la décoration sur assiette avec sauces ou coulis. Avec bouchon

| | □ cm | ↑ cm | ltr. | |
|---------|-------|------|------|--|
| 93154 1 | Ø 5 | 18 | 0,2 | |
| 93163 3 | Ø 5,5 | 19 | 0,35 | |



93155 700 ml 93156 700 ml 93157 700 ml

**Quetschflasche
squeeze bottle
bote dosificador flexible
bouteille verseuse souple**



mit Verschlusskappe
with cap
con tapón
avec bouchon

| | □ cm | ↑ cm | ltr. | |
|---------|------|------|------|---|
| 93155 8 | Ø 7 | 24 | 0,7 | ● |
| 93156 5 | Ø 7 | 24 | 0,7 | ● |
| 93157 2 | Ø 7 | 24 | 0,7 | ○ |



Backhandschuhe
baking mittens
manoplas de panadero
gants de boulanger

Leder, gefüttert, one size, mit Stulpen, extrem hitzebeständig bis 250°C
 leather, inner lining, one size, with cuffs, extremely heat resistant up to 250°C
 cuero interior forrado, talla única, resiste temperaturas hasta 250°C
 cuir intérieur doublé, taille unique, résiste à maxi 250°C

| | → cm |
|---------|------|
| 88090 0 | 45 |



Pizzaschaufel
pizza peel
pala de pizza
pelle à pizza



| | □ cm | → cm |
|---------|-----------|------|
| 88080 1 | 35 x 30,5 | 90 |
| 88081 8 | 35 x 30,5 | 130 |

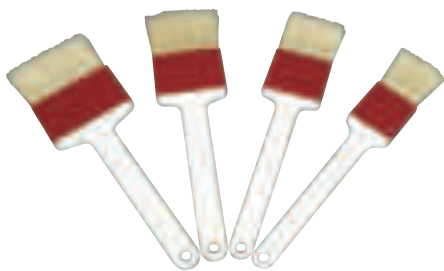

Pinsel
brush
brocha
pinceau pâtissier



weißgebleichte naphthalinfreie Borsten, temperaturbeständig von -40°C bis +95°C
 bleached bristles, heat-resistant from -40°C to +95°C
 cerdas blanqueadas resistencia térmica -40°C to +95°C
 soies blanchies sans naphthaline, résistance de - 40°C à + 95°C

| | □ cm | → cm |
|---------|---------|------|
| 77350 9 | 4 x 1 | 23,5 |
| 77351 6 | 5 x 1 | 23,5 |
| 77352 3 | 6 x 1 | 24 |
| 77353 0 | 7,5 x 1 | 24 |



Gewürzkasten
condiment container
especiero
boîte à épices ou ingrédients



matt poliert, 4 herausnehmbare Einsatzschalen je 0,5 l, Scharnierdeckel aus Polycarbonat
 satin polished finish, 4 removable inserts each 0,5 l, hinged polycarbonate lid
 acabado mate, cuatro contenedores en propileno, capacidad de cada uno 0,5l, tapa policarbonato alta calidad con bisagra
 mat, 4 compartiments de 0,5 L en polypropylène, couvercle polycarbonate à charnières

| | □ cm | ↑ cm | ltr. |
|---------|-----------|------|---------|
| 71700 8 | 31 x 15,5 | 9,5 | 4 x 0,5 |

Einzelteile / spare parts / piezas sueltas / pièces détachées

| Einsatzschale / insert / contenedor 0,5 L / récipient 0,5 L | | | |
|---|------------|---|-----|
| 71701 5 | 14,2 x 7,5 | 7 | 0,5 |

NEW



Vorratsdose mit Deckel
canister with lid
contenedor con tapa
pot en verre avec couvercle



Glaskugel mit Schraubdeckel, aromadichtem Verschluss, 1 Stck.

glass ball, aroma-tight screw cap, 1 pc.

bola de cristal, tapa de rosca aroma apretado, 1 pc.

boule de verre, bouchon à vis de l'arôme étanche, 1 pz.

| | cm | cm | litr. |
|---------|-----------|----|-------|
| 00637 9 | 12,5 x 19 | 18 | 1 |



Vorratsdose
canister with spoon
bote con cuchara
pot en verre avec cuillère



Glaskugel mit Löffel, Schraubdeckel mit aromadichtem Verschluss, Edelstahl-Löffel mit magnetischem Silikongriff, 1 Stck.

tight cover, stainless steel spoon with magnetic silicone handle, 1 pc.

acero inoxidable, tapa de vidrio ajustable cuchara inox con mango magnético de silicona, 1pc.

pot en verre avec cuillère avec manche aimanté revêtu de silicone, couvercle à visser pour conserver les arômes, 1 pz.

| | cm | cm | litr. |
|---------|------|----|-------|
| 00636 2 | Ø 20 | 18 | 3 |



mit Vakuum-Saugfuß,
somit kein Verrutschen
oder Kippen

Küchentuchständer
paper towel holder
porta-rollo de cocina
dérouleur papier essuie-tout



matt poliert, der Federbügel ermöglicht eine problemlose 1-Hand-Bedienung, mit neuartigem Vakuum-Saugfuß, Lieferung ohne Papierrolle

satín polished finish, the strap allows an easy one-hand operation, suitable for all standard paper towel rolls, a suction foot avoids slipping, delivery without paper towel roll

acabado satinado, uso con una mano con la palanca de presión, para rollos estándar, pie con ventosa. Se entrega sin rollo

mat satiné, facile à utiliser d'une seule main grâce au levier de pression, pour rouleaux standard, pied avec ventouse. Livré sans rouleau de papier.

| | cm | cm |
|---------|------|----|
| 70306 3 | Ø 18 | 35 |



Küchentuchständer
kitchen roll holder
porta-rollo de cocina
dérouleur papier essuie-tout



Lieferung ohne Deko

delivery without paper towel roll

Se entrega sin rollo

Livré sans rouleau de papier.

| | cm | cm |
|---------|------|----|
| 70303 2 | Ø 18 | 31 |



**Bonspieß
bill spike
pinchanotas
pique-bons**



Spieße aus flexiblen Kunststoff, mit stumpfen Enden zur Unfallverhütung
spikes made of flexible plastic, with blunt ends to prevent accidents
pinchos de plástico flexible
piques en plastique flexible

| | ☐ cm | ↑ cm | |
|---------|----------|------|---|
| 88855 5 | 9 x 5,5 | 10,5 | 1 Spieß / 1 spike 1 pincho / 1 pic |
| 88856 2 | 20 x 5,5 | 10,5 | 3 Spieße / 3 spikes 3 pinchos / 3 pics |

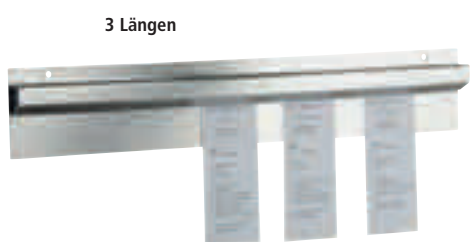

**Bonleiste
bill rail
portafichas
barre porte-bons**



matt poliert, mit Kugel-Greifsystem, zur Wandmontage geeignet, auch mit Magneten nutzbar
satin polished finish, small balls hold the bills, suited for wall fastening, can also be used with magnets
acabado satinado, con sistema de bolas para colgar las notas para fijar en la pared, puede usarse con imán
mat satiné, avec billes pour fixer sans effort tous types de fiches et papiers. Peut se fixer sur plaque aimantée.

| | ☐ cm | ↑ cm |
|---------|--------|------|
| 88900 2 | 40 x 8 | 2 |
| 88901 9 | 50 x 8 | 2 |
| 88902 6 | 60 x 8 | 2 |



**Magnet-Messerhalter
magnetic knife rack
barra magnética para cuchillos
barre aimantée pour couteaux**



mit 2 Magnetschienen und Haken, aus massivem Kunststoff, zur Wandmontage geeignet, Lieferung ohne Deko
with 2 magnet racks and hooks, strong plastic, suited for wall fastening
con 2 rieles magnéticos y ganchos, plástico macizo, fijación en pared.
avec 2 rails aimantés et crochets, plastique robuste, fixation murale

| | → cm |
|---------|------|
| 88910 1 | 33 |
| 88911 8 | 45 |
| 88912 5 | 60 |



**Schneidbrett-Ständer
cutting board rack
soporte para tablas
rack pour planches à découper**



für 6 Schneidbretter bis 25 mm Stärke, Lieferung ohne Deko
for 6 chopping boards up to 25 mm thickness
para 6 tablas de corte de 25 mm.
pour planches de 25 mm

| | ☐ cm | ↑ cm |
|---------|---------|------|
| 88903 3 | 27 x 31 | 28 |



Sterntüllen-Satz, 10er Set
set of star tubes, 10 pcs. set
juego de 10 boquillas estrella
jeu de 10 douilles en étoile



aus einem Stück gezogen, 10-teilig: 4, 5, 6, 7, 8, 9, 10, 12, 13, 15 mm
 made in one piece, 10 pcs. set: 4, 5, 6, 7, 8, 9, 10, 12, 13, 15 mm
 fabricación de 1 sola pieza 4,5,6,7,8,9,10,12,13 y 15 mm
 fabrication d'une seule pièce 4,5,6,7,8,9,10,12,13 et 15 mm

77331 8



Lochtüllen-Satz, 10er Set
set of plain tubes, 10 pcs. set
juego de 10 boquillas lisas redondas
jeu de 10 douilles lisses rondes



aus einem Stück gezogen, 10-teilig: 4, 5, 6, 7, 8, 9, 10, 12, 13, 15 mm
 made in one piece, 10 pcs. set: 4, 5, 6, 7, 8, 9, 10, 12, 13, 15 mm
 fabricación de 1 sola pieza 4,5,6,7,8,9,10,12,13 y 15 mm
 fabrication d'une seule pièce 4,5,6,7,8,9,10,12,13 et 15 mm

77332 5



Tüllenkassetten-Set, 12er Set
pipng tubes set, 12 pcs. set
caja de 12 boquillas
boîte de 12 douilles



Farbe: elfenbein, 12 verschiedene Tüllen: 4 Sterntüllen, 4 Lochtüllen, 4 Garniertüllen
 ivory-coloured, 12 different tubes: 4 star tubes, 4 plain tubes, 4 decoration tubes
 polipropileno color marfil, 12 boquillas: 4 estrellas, 4 redondas, 4 decorados surtidos
 polypropylène blanc cassé, 12 motifs différents: 4 en étoile, 4 ronds, 4 décors assortis

↑ cm

77333 2

6



Spritzbeutel
pastry bag
manga pastelera
poche pâtissière

Baumwollgewebe mit starker Spezialbeschichtung, mit Saum und Tüllenverstärkung,
 verschweißte Längsnaht, mehrmals verwendbar, undurchlässig

cotton fabric with strong special coating, with upper seam and reinforced tip, welded seam,
 useable several times, impermeable

tejido algodón con revestimiento especial muy resistente y refuerzo en costura y punta para
 uso alimenticio, costura soldada, reutilizable, impermeable

toile de coton avec revêtement spécial très résistant, couture soudée, base pour la douille
 renforcée, réutilisable, imperméable

| | Größe | → cm |
|---------|-------|------|
| 77320 2 | 0 | 25 |
| 77321 9 | 1 | 28 |
| 77322 6 | 2 | 34 |
| 77323 3 | 3 | 40 |
| 77324 0 | 4 | 45 |
| 77325 7 | 5 | 50 |
| 77326 4 | 6 | 55 |
| 77327 1 | 7 | 60 |



Dessert- und Tortenring
dessert and tart ring
aro de tarta
cercles à gâteaux



nahtgeschweißt
welded seam
aluminio soldado
aluminium, soudé

| | ☐ cm | ↑ cm | |
|---------|------|------|--|
| 77380 6 | Ø 18 | 6 | |
| 77381 3 | Ø 20 | 6 | |
| 77382 0 | Ø 22 | 6 | |
| 77383 7 | Ø 24 | 6 | |
| 77384 4 | Ø 26 | 6 | |
| 77385 1 | Ø 28 | 6 | |

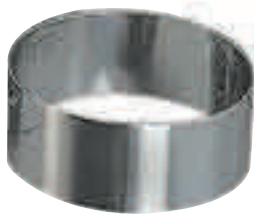

Tortenring
cake setting ring
aros tarta
cercles à gâteaux



stufenlos verstellbar
adjustable
ajustables
ajustables

| | ☐ cm | ↑ cm | |
|---------|-------------|------|-----------------------------|
| 00040 7 | Ø 16,5 - 32 | 7 | ohne Griff / without handle |

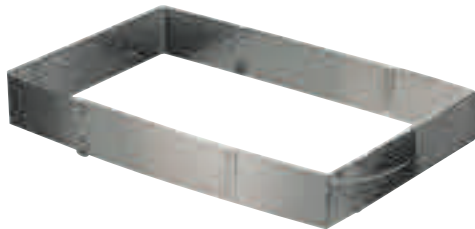

Backform
cake setting ring
marco pastelero
forme à gateaux



stufenlos verstellbar, aus flexiblem Edelstahl
adjustable
ajustable
ajustable

| | ☐ cm | ↑ cm | |
|---------|-------------------|------|--|
| 00042 1 | 19 x 28 - 34 x 54 | 5 | |



Kuchen- / Quiche-Form
cake / quiche mould
molde tarta o quiche
moule à tarte ou quiche



Metall, Antihaft-Beschichtung, mit herausnehmbaren Bodenteil, rund gewellt
metal, non-sticking coating, with removable bottom, round, fluted
metal con revestimiento antiadhrente fondo desmontable borde rizado
métal avec revêtement anti-adhérent, fond démontable, bord cannelé

| | ☐ cm | ↑ cm | |
|---------|------|------|--|
| 77302 8 | Ø 24 | 3,5 | |
| 77303 5 | Ø 26 | 3,5 | |
| 77304 2 | Ø 28 | 3,5 | |
| 77305 9 | Ø 32 | 3,5 | |



2 Seiten = 2 Teilungen
12/16 - 12/18 - 14/16

Tortenteiler
cake marker
marcador de pasteles
disque à marquer les parts



elfenbein, beidseitig verwendbar, mit 2 Griffen
ivory-coloured, double sided, with 2 handles
polipropileno, doble cara, con 2 asas
polypropilène, 2 faces, avec 2 poignées

| | ☐ cm | ↑ cm | |
|---------|--------|------|---|
| 88060 3 | Ø 26,5 | 2,5 | 12 oder 16 Segmente / 12 or 16 pcs. 12 o 16 porciones / 12 ou 16 parts |
| 88061 0 | Ø 26,5 | 2,5 | 12 oder 18 Segmente / 12 or 18 pcs. 12 o 18 porciones / 12 ou 18 parts |
| 88062 7 | Ø 26,5 | 2,5 | 14 oder 16 Segmente / 14 or 16 pcs. 14 o 16 porciones / 14 ou 16 parts |



Backblech
baking sheet
placa pastelera
plaque à pâtisserie



gelocht Ø 3 mm, Materialstärke 1,5 mm, Silikon beschichtet, temperaturbeständig bis 240°C
perforated Ø 3 mm, coated with silicon, heat resistant up to 240°C
aluminio con revestimiento de silicona perforada, resistente hasta 240°
aluminium avec revêtement silicone, perforée, température maxi 240°

| | ☐ cm | GN |
|---------|-----------|-----|
| 88285 0 | 53 x 32,5 | 1/1 |

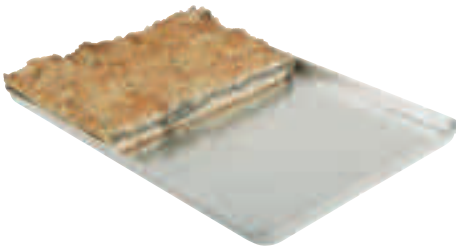

Ausstellblech / Thekenblech
display tray
bandeja pastelera
plaque pâtissière



| | ☐ cm | ↑ cm |
|---------|---------|------|
| 13377 8 | 40 x 25 | 2 |
| 13378 5 | 48 x 32 | 2 |
| 13379 2 | 60 x 40 | 2 |



Korkuntersetzer
cork mat
salvamanteles
dessous-de-plat liège



ideal für Servier- und Eisenpfannen
ideal for iron pan
ideal para servir en sartenes de chapa
idéal pour présenter les poèles forgées sur table

| | ☐ cm | ↑ cm |
|---------|------|------|
| 73750 1 | Ø 24 | 2 |



Servier- / Tortenplatte
cake stand
sporte para pastel
présentoir à gâteaux



hochglanzpoliert, mit hohem Fuß (fest verbunden)
 mirror polished finish, with tall foot
 acabado brillante, con pie alto
 poli brillant, pied haut

| | □ cm | ↑ cm |
|---------|--------|------|
| 00466 5 | Ø 34,5 | 13,5 |

passendes Zubehör / suitable accessories
accesorios a juego / accessoires assortis



Frischhalte-Haube / cover / campana / cloche

| | | |
|---------|------|------|
| 06517 8 | Ø 33 | 12,5 |
|---------|------|------|

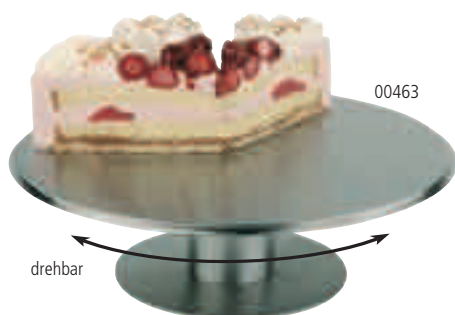

Servierplatte / Tortenplatte „INOX“
plate / cake plate
porta tartas
guéridon à gâteau



matt poliert, drehbar, möbelschonende Moosgummi-Unterseite
 satin polished finish, rotating, foam rubber below to save your furniture
 acabado pulido satinado, giratorio, base revestida de goma para no rallar el mobiliario
 poli satiné, plateau tournant, revêtement mousse sous le pied pour ne pas rayer les meubles

| | □ cm | ↑ cm |
|---------|--------|------|
| 00463 4 | Ø 30,5 | 9 |

passende Abdeckhaube
06510



passendes Zubehör / suitable accessories
accesorios a juego / accessoires assortis



Frischhalte-Haube / cover / campana / cloche

| | | |
|---------|------|------|
| 06510 9 | Ø 30 | 11,5 |
|---------|------|------|



Tortenplatte
cake plate
porta tarta
guéridon à gâteau



Fuß hochglanzpoliert, Platte matt poliert, stabil und sehr standsicher
 foot mirror polished finish, plate satin polished finish
 pie pulido brillante, bandeja pulida mate
 pied brillant, plateau poli satin mat

| | □ cm | ↑ cm |
|---------|------|------|
| 00462 7 | Ø 30 | 11 |

passendes Zubehör / suitable accessories
accesorios a juego / accessoires assortis



Frischhalte-Haube / cover / campana / cloche

| | | |
|---------|------|----|
| 06501 7 | Ø 30 | 11 |
|---------|------|----|



Konditorplatte
cake plate
porta tartas confitería
plateau à gâteaux avec pied



matt poliert
 satin polished finish
 acabado efecto satinado
 poli mat effet satin

| | cm | cm | |
|---------|------|----|--|
| 00046 9 | Ø 31 | 3 | |

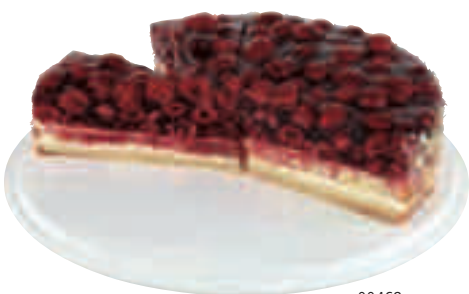

00468



00469



Abgesenkter Rand fixiert die Haube und vereinfacht das Abheben von Tortenstücken. Kein Abrutschen der Haube.

Tortenplatte
cake tray
bandeja para tarta
plat à tarte



Rand fixiert die Haube, mit Antirutsch-Füßchen
 carved edge fixes the cover, non-slip feet
 ranura para fijar bien la campana, pies antideslizantes
 bord rainuré pour maintien ferme de la cloche, pieds anti-glisse

| | cm | cm | |
|---------|------|----|---|
| 00468 9 | Ø 31 | 4 | ○ |
| 00469 6 | Ø 31 | 4 | ● |

passendes Zubehör / suitable accessories
accesorios a juego / accessoires assortis



Frischhalte-Haube / cover / campana / cloche

| | | | |
|---------|------|-----|--|
| 06504 8 | Ø 30 | 9,5 | |
|---------|------|-----|--|

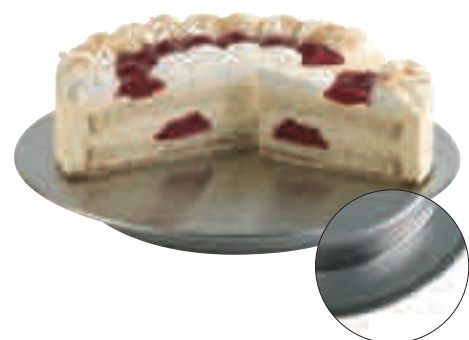

Konditorplatte „PRO“
cake plate
porta tartas
présentoir à gâteaux



matt poliert
 satin polished finish
 acabado pulido efecto satinado
 poli mat effet satin

| | cm | cm | kg |
|---------|------|----|------|
| 00465 8 | Ø 31 | 4 | 1,13 |



Kuchenheber
cake lifter
pala/bandeja para tarta
pelle/plateau à gâteau



spiegelblank, bessere Handhabung durch ergonomischen Griff
 shiny surface, easy handling, ergonomic handle
 superficie brillante, fácil manejo, ergonómico
 brillant, pratique, sûr et ergonomique

| | cm | |
|---------|------|--|
| 00045 2 | Ø 30 | |



Servier- und Tortenplatte „CASUAL“
 cake plate
 porta pateles
 présentoir à gâteaux



| | cm | cm |
|---------|------|----|
| 83890 1 | Ø 31 | 8 |
| 83891 8 | Ø 31 | 16 |



Servier- und Tortenplatte „CASUAL“
 cake plate
 porta pateles
 présentoir à gâteaux



| | cm | cm |
|---------|---------|----|
| 83892 5 | 31 x 31 | 8 |
| 83893 2 | 31 x 31 | 16 |





in 2 Breiten lieferbar:
30 oder 45 cm

Folien-Abreibvorrichtung, mit Abreibkante / Säge
clingfilm tear-off-dispenser
dispensador de film
dérouleur de film



mit Abreibkante / Säge-Messer, für Endlosfolie, als Tischgerät oder Wandgerät verwendbar
with saw, for endless rolls, can be fixed on the wall
con sierra para rollo de film continuo, se puede fijar en la pared
avec lame dentée pour rouleau de film, peut être fixé au mur

| | cm | cm | |
|---------|---------|----|--|
| 88288 1 | 34 x 16 | 9 | für Folienbreite 30 cm for film width 30 cm para film ancho 30 cm pour film largeur 30 cm |
| 88287 4 | 49 x 16 | 9 | für Folienbreite 45 cm for film width 45 cm para film ancho 45 cm pour film largeur 45 cm |



Messerabstreihbehälter
knife cleaner
limpiador de cuchillos
dispositif pour nettoyer les lames de couteaux



mit Aufsatz, schwere Qualität, Abstreihbacken aus Gummi in Lebensmittelqualität (verstellbar), hitzebeständig bis 80°C, Bodeneinlagen aus weichem Kunststoff zum Schonen der Messerspitzen

heavy gauge, with rubber top insert adequate for food contact and heat-resistant up to 80°C, soft plastic lower base to protect blade tips

alta calidad, limpiador de goma apto para alimentos, resistente hasta 80°C, base de plástico blando para proteger las puntas de los cuchillos

qualité professionnelle, insert supérieur nettoyeur de lames en caoutchouc alimentaire résistant maxi 80°C, base en plastique pour protéger les pointes des lames

| | cm | cm | ltr. |
|---------|----|----|------|
| 88111 2 | 13 | 18 | 1,3 |



Eiswaffel-Ständer
cornet stand
soporte para cornetes
support cornets



mit 4 Löchern, 2 x Ø 31 mm + 2 x Ø 26 mm
with 4 holes, 2 x Ø 31 mm + 2 x Ø 26 mm
con 4 agujeros, 2 x Ø 31 mm + 2 x Ø 26 mm
4 trous, 2 x Ø 31 mm + 2 x Ø 26 mm

| | cm | cm |
|---------|------------|----|
| 11894 2 | 24,5 x 9,5 | 9 |



Eiswaffel-Ständer
cornet stand
Soporte cucuruchos
support à cornets



matt poliert, mit 4 Löchern, 2 x Ø 31 mm + 2 x Ø 26 mm
satin polished finish, with 4 holes, 2 x Ø 31 mm + 2 x Ø 26 mm
Acero inoxidable con 4 plazas 2 x Ø 31 mm + 2 x Ø 26 mm
inox, 4 places - 2 x Ø 31 mm + 2 x Ø 26 mm

| | cm | cm |
|---------|------------|----|
| 11881 2 | 9,5 x 27,5 | 9 |

Kellen . Rührer . Schnitzer . Wender . Zangen
ladles . stirrer . carver . turner . tongs
cucharones . espátulas . batidores . pinzas
louches . spatules . fouets . pince



Kugelausstecher - doppelt „ORANGE“
melon baller - double
vaciador doble de bola
moule à boule double



zum Formen von Kugeln aus Obst, Gemüse oder Butter, Edelstahl mit geschärften Rändern
 to form balls out of fruits, vegetables, butter, etc., stainless steel with sharpened edge
 para hacer bolas con frutas, verduras, mantequilla, etc. Acero inoxidable con borde afilado
 pour faire des boules de fruits, légumes, beurre, etc. Inox, bord affûté

| | ☐ cm | → cm |
|---------|-------------|------|
| 88810 4 | Ø 2,2 + 2,5 | 16,5 |
| 88811 1 | Ø 2,2 + 3,0 | 17 |



Kugelausstecher - oval gerippt „ORANGE“
melon baller - oval fluted
vaciador ovalado de melón, acanalado
moule à boule, ovale cannelée



zum Formen von oval gerippten Kugeln aus Obst, Gemüse oder Butter, Edelstahl mit geschärften Rändern
 to form oval fluted balls out of fruits, vegetables, butter, etc., stainless steel with sharpened edge
 para hacer bola con frutas, verduras, mantequilla, etc. Acero inoxidable con borde afilado
 pour faire des boules de fruits, légumes, beurre, etc. Inox, bord affûté

| | ☐ cm | → cm |
|---------|-----------|------|
| 88812 8 | 3,3 x 1,9 | 16 |



Kugelausstecher - oval „ORANGE“
melon baller - oval
vaciador ovalado de melón, liso
moule à boule, ovale lisse



zum Formen von ovalen Kugeln aus Obst, Gemüse oder Butter, Edelstahl mit geschärften Rändern
 to form oval balls out of fruits, vegetables, butter, etc., stainless steel with sharpened edge
 para hacer bolas con frutas, verduras, mantequilla, etc. Acero inoxidable con borde afilado
 pour faire des boules de fruits, légumes, beurre, etc. Inox, bord affûté

| | ☐ cm | → cm |
|---------|-----------|------|
| 88813 5 | 3,3 x 1,9 | 16 |



Herz-Ausstecher

Kugelausstecher - Herzform „ORANGE“
melon baller - heart-shaped
vaciador de melón-forma de corazón
moule à boule en coeur



zum Formen von Herzen aus Obst, Gemüse oder Butter, Edelstahl mit geschärften Rändern
 to form hearts out of fruits, vegetables, butter, etc., stainless steel with sharpened edge
 para hacer bolas con frutas, verduras, mantequilla, etc. Acero inoxidable con borde afilado
 pour faire des boules de fruits, légumes, beurre, etc. Inox, bord affûté

| | ☐ cm | → cm |
|---------|---------|------|
| 88851 7 | 3 x 2,5 | 16 |



Kugelausstecher „ORANGE“
melon baller
vaciador de melón redondo
moule à boule ronde simple



zum Formen von Kugeln aus Obst, Gemüse oder Butter, Edelstahl mit geschärften Rändern
 to form balls out of fruits, vegetables, butter, etc., stainless steel with sharpened edge
 para hacer bolas con frutas, verduras, mantequilla, etc. Acero inoxidable con borde afilado
 pour faire des boules de fruits, légumes, beurre, etc. Inox, bord affûté

| | □ cm | → cm |
|---------|-------|------|
| 88814 2 | Ø 3 | 16 |
| 88815 9 | Ø 2,5 | 16 |
| 88816 6 | Ø 2,2 | 15,5 |
| 88817 3 | Ø 1,8 | 15 |
| 88818 0 | Ø 1,5 | 15 |
| 88819 7 | Ø 1,0 | 14,5 |



88820



88821

Ziseliermesser „ORANGE“
lemon stripper
cuchillo de decoración cincelador
décore-citron ou zesteur



zum Einritzen von Linien und Mustern in hartschaliges Obst und Gemüse, zum Schälen von Zitrusfrüchten, Edelstahl mit geschärften Rändern

to score lines or design in hard fruits and vegetables, to peel citrus fruits, stainless steel with sharpened edge

para esculpir líneas o hacer dibujos sobre frutas o verduras, bastante duras para pelar cítricos, acero inoxidable con borde afilado

pour découper des lignes et motifs sur fruits et légumes à peau dure ou pour peler les zestes des citrons ou oranges, inox, bord affûté

| | → cm | |
|---------|------|--|
| 88820 3 | 15 | für Rechtshänder / for right-handers para diestros / pour droitiers |
| 88821 0 | 15 | für Rechts- und Linkshänder for right- and left-handers para diestros y zurdos pour gauchers ou droitiers |



Spargelschäler „ORANGE“
asparagus knife / asparagus peeler
pelador de espárragos
peleur à asperges



schält Spargel sparsam und gleichmäßig, mit Stellschraube für variable Schneiddicken

peels asparagus curt and consistant, with adjustable screw to change the thickness of peeling

pela los espárragos uniformemente, tornillo para regular el grosor del pelado

pèle les asperges uniformément, avec vis de réglage pour l'épaisseur des pelures

| | → cm |
|---------|------|
| 88822 7 | 22 |



Fadenschneider / Zester „ORANGE“
decorator / zester
cuchillo de decoración cincelador
couteau zesteur



zum Abziehen von feinsten Schalenstreifen, ideal zum Dekorieren von Torten und Desserts
 to peel off very fine stripes of paring, these stripes are ideal to decorate desserts, cakes, etc.
 para pelar tiras muy finas, ideal para decorar postres, tartas, etc
 pour couper en lanières fines, idéal pour la décoration de gâteaux et desserts, etc



| | ☐ cm | → cm |
|---------|-------------|------|
| 88823 4 | Ø 0,2 + 0,5 | 14,5 |
| 88824 1 | Ø 0,2 | 15 |



Fadenschneider - seitlich „ORANGE“
decorator / zester - sideways
cuchillo de decoración cincelador
couteau zesteur „de côté“



zum Abziehen von feinsten Schalenstreifen, ideal zum Dekorieren von Torten und Desserts
 to peel off very fine stripes of paring, these stripes are ideal to decorate desserts, cakes, etc.
 para pelar tiras muy finas, ideal para decorar postres, tartas, etc
 pour couper en fines lanières, idéal pour la décoration de gâteaux et desserts, etc



| | ☐ cm | → cm |
|---------|-------------|------|
| 88825 8 | Ø 0,3 + 0,4 | 15 |



Ziseliermesser „ORANGE“
canele / decorating knife
cuchillo de decoración cincelador acanalado
couteau zesteur cannelé



zum Einritzen von Linien und Mustern in hartschaliges Obst und Gemüse, Edelstahl mit geschärften Rändern
 to score lines or design in hard fruits and vegetables, stainless steel with sharpened edge
 para dibujar líneas en frutas o verduras de piel dura, acero inoxidable con borde afilado
 pour découper des lignes et motifs sur fruits et légumes à peau dure ou pour peler les zestes des citrons ou oranges, inox, bord affûté



| | → cm |
|---------|------|
| 88826 5 | 15 |



Sparschäler „ORANGE“
peeler
pelador de espárragos
peleur à asperges



für Links- und Rechtshänder geeignet, mit zwei starren Klingen aus extra geschärftem + gehärtetem Edelstahl

useable left- and right handed, with 2 inflexible blades made out off sharpened, extra hardened stainless steel

para diestros y zurdos, con 2 cuchillas rígidas inox afiladas y muy resistentes

pour gauchers ou droitiers, 2 lames rigides affûtés en inox extra-résistant



| | → cm |
|---------|------|
| 88827 2 | 17 |

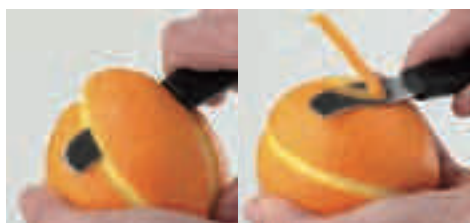

Orangenschäler „ORANGE“
orange peeler
pelador de naranjas
peleur à oranges



zum Einritzen von Linien in hartschaligen Zitrusfrüchten, zum Schälen von Zitrusfrüchten ohne das Fruchtfleisch zu verletzen, Edelstahl mit Ziselierhaken

to score lines and design hard fruits and vegetables, to peel fruits without bashing the pulp, stainless steel with hook

para dibujar líneas en frutas y verduras de piel dura para pelar cítricos sin dañar la pulpa, acero inoxidable con gancho

pour découper des lignes et motifs sur fruits et légumes à peau dure ou pour peler les citrons ou oranges sans endommager la pulpe, inox, bord affûté



| | | |
|---------|------|--|
| | → cm | |
| 88828 9 | 17,5 | |



Pizzateigschneider „ORANGE“
pizza cutter
cortador de pizza
roulette à pizza



zum einfachen Zerteilen von Pizza

to cut pizza easily

para cortar piza fácilmente

pour une coupe facile de la pizza



| | | |
|---------|-----|------|
| | cm | → cm |
| 88829 6 | ∅ 6 | 18,5 |



Teigrad - gewellt „ORANGE“
pastry cutter - fluted wheel
cortador de pastelería- rueda dentada
roulette à pâte, cannelée



ideal zur Pasta-Herstellung, zum leichten Trennen von Teig

ideal for making pasta, to cut dough easily

ideal para la pasta

idéal pour les pâtes maison



| | | |
|---------|-----|------|
| | cm | → cm |
| 88830 2 | ∅ 6 | 18,5 |



Butterroller „ORANGE“
butter curler
rizador de mantequilla
coquilleur à beurre



zum Formen von dekorativen Butterflocken

to form decorative curls out of butter

para formar rizos decorativos con mantequilla

pour faire des rubans et coquilles de beurre



| | |
|---------|------|
| | → cm |
| 88831 9 | 19 |



Dekoriermesser „ORANGE“
fruit decorating knife
cuchillo para decorar fruta
denteleur



zur attraktiven Dekorierung von Früchten und Gemüse, Edelstahl mit geschärften Rändern
 to decorate fruits and vegetables attractive, stainless steel with sharpened edge
 para decorados atractivos de frutas y verduras, acero inoxidable con borde afilado
 pour une découpe attractive et originale des kiwis, tomates, melons et autres fruits ou légumes

→ cm
 88832 6 16



Pellkartoffelgabel „ORANGE“
potato holder
tenedor aguanta patatas
pic à pommes de terre



zum Aufnehmen und Halten von heißen Kartoffeln, mit drei Drahtzinken
 to pick up and hold hot potatoes with three prongs
 para sujetar patatas calientes con 3 pinchos
 pour tenir les pommes de terre et ainsi les peler sans se brûler, trident

→ cm
 88833 3 16



Pendelschäler „ORANGE“
swivel peeler
pelador lama pivotante
peleur lame pivotante



zum schnellen und sparsamen Schälen von Obst und Gemüse, mit beweglicher Klinge
 to peel fruits and vegetables with flexible blade
 para pelar frutas y verduras con hoja flexible, endurecido y afilado
 lame flexible

→ cm
 88834 0 17



Entstieler / Entkerner „ORANGE“
tomato corer
quita-rabillo de tomate
équeuteur à tomates



zum einfachen Entfernen des Tomatenstiels, aus Edelstahl mit gezackter Krone
 to remove the peduncles from tomatoes in one movement, can be used to remove the pulp of the tomato

ideal para cortar el rabo de los tomates de 1 gesto, o para hacer bolas de pulpa de tomate, inox, dentado

pour ôter la queue de la tomate en 1 seul geste ou pour former des boules avec la pulpe. Inox, dentelé, inox

□ cm → cm
 88835 7 2 x 2 15



Apfelentkerner „ORANGE“
apple corer
descorazonador de manzana
vide-pomme



durch leichtes Drehen kann das Kerngehäuse von Äpfeln, Birnen und anderen Früchten sorgsam herausgeholt werden, Edelstahl mit geschärften Rändern

with a light turn cores of apples, pears and other fruits can be cut off easily, stainless steel with sharpened edge

para descorazonar muy fácilmente manzanas, peras y otras frutas

pour évider facilement les pommes, poires ou autres fruits



| | □ cm | → cm |
|---------|-------|------|
| 88836 4 | Ø 2,2 | 21 |
| 88837 1 | Ø 1,6 | 18,5 |



Dreieck-Garnierschneider „ORANGE“
decorator / radish decorator
cincelador triangular
couteau ciseleur triangle



zur Herstellung von Radieschenkronen, zur Verzierung von Gemüse und Obst, Edelstahl mit geschärften Rändern

to cut lines and design in fruits and vegetables, stainless steel with sharpened edge

para cortar líneas y hacer dibujos en frutas y verduras, acero inoxidable con borde afilado

pour dessiner ligne et motifs sur les fruits et légumes à peau dure, lame affûtée, inox



| | → cm |
|---------|------|
| 88838 8 | 14 |



Austernöffner „ORANGE“
oyster knife
abre ostras
couteau à huîtres



zum einfachen Aufbrechen von Austern, mit Fingerschutz, Edelstahl mit geschärften Rändern

to open oysters easily, with guard, stainless steel with sharpened edge

para abrir ostras fácilmente con protección para los dedos, acero inoxidable con punta afilada

pour ouvrir facilement les huîtres avec protection pour les doigts, inox, pointe affûtée, inox



| | → cm |
|---------|------|
| 88839 5 | 14,5 |



Austernmesser „ORANGE“
oyster knife
abre ostras
couteau à huîtres



Edelstahl-Klinge zum Einstechen in die Schale, mit Fingerschutz

to open oysters easily, with guard

para abrir ostras fácilmente con protección para los dedos

pour ouvrir facilement les huîtres avec protection pour les doigts



| | → cm |
|---------|------|
| 88840 1 | 15 |



Grapefruitmesser „ORANGE“
grapefruit knife
cuchillo para pomelo
couteau à pamplemousse



zum Filetieren von Zitrusfrüchten, inkl. Ziselierhaken zum Einritzen der Schale, Edelstahl mit beidseitigem Sägeschliff

to fillet citrus fruits incl. sharpened hook, to open the paring, stainless steel serrated on both sides

para cortar la pulpa del pomelo, hoja curvada dentada por ambos lados para zurdos y diestros, final en punta para pinchar, inox

lame fine recourbée microdentée des 2 côtés pour droitiers/gauchers, coupe aisément la chair du fruit et la lame en pointe permet de la piquer inox

→ cm

88841 8 21



Zucchinienkerner „ORANGE“
courgette / zucchini cutter
vaciador para calabacín
évideur à courgette



zum Entkernen von Zucchini oder ähnlichem Obst und Gemüse, Edelstahl mit geschärfter Spitze und gezackter Klinge

to remove cores out of zucchini and alike fruits and vegetables, stainless steel with sharpened top and serrated blade

para vaciar el corazón del calabacín o de cualquier otra fruta o verdura, acero inoxidable con hoja de sierra afilada

pour évider courgettes, aubergines, concombres ou autres fruits et légumes allongés, lame inox dentée et pointe affûtée

→ cm

88842 5 23



Dekoriermesser „ORANGE“
decorating knife „cannelé“
cuchillo acanalador
couteau cannelé



gezahnte Klinge aus geschärftem Edelstahl

serrated sharpened blade, stainless steel

hoja de sierra afilada, acero inoxidable

lame inox microdentée

→ cm

88843 2 19



Tourniermesser „ORANGE“
paring knife
cuchillo curvado
couteau d'office bec d'oiseau



Klinge in Schnabelform, Klinge passt sich Rundungen perfekt an

with curved blade, blade adaptes perfect to curves

con hoja curva, acero inoxidable, hoja perfecta para productos redondos

lame inox, idéale pour produits ronds

→ cm

88844 9 17,5



Gemüsemesser „ORANGE“
paring knife
cuchillo mondador
couteau d'office



zum schnellen Schälen von Gemüse
to cut vegetables and fruits quickly
para cortar frutas y verduras con rapidez, acero inoxidable
lame inox, idéale pour la coupe rapide de fruits et légumes



→ cm
88845 6 21



Cocktailmesser
bar knife
cuchillo para cóctel
couteau cocktail



mit 2 Zinken zum Aufspießen von Zitruscheiben
with 2 prongs to pick up slices of lemon
con 2 dientes para pinchar las rodajas de limón, etc.
avec 2 dents pour les rondelles de citron et autres décorations



→ cm
88846 3 21



Käsemesser „ORANGE“
cheese knife
cuchillo de queso
couteau à fromage



→ cm
88847 0 21



Julienneschneider „ORANGE“
julienne cutting knife
cuchillo para cortar juliana
couteau à julienne



zum Schneiden feiner Streifen aus Gemüse oder Obst
to cut fine stripes out off fruits and vegetables
para cortar a tiras finas las frutas y verduras, inox, hoja afilada
pour couper en fines lanières les fruits et légumes



→ cm
88848 7 18,5



Pendelschäler „ORANGE“
swivel peeler
pelador reversible
éplucheur droitier/gaucher



für Links- und Rechtshänder geeignet, mit 2 beweglichen Klingen
 suitable for right and left handed, with 2 flexibles blades
 apto para zurdos como para diestros, con 2 hojas flexibles acero inoxidable
 adapté pour droitiers ou gauchers, lame inox flexible

→ cm
 88849 4 19



Pendelschäler „ORANGE“
swivel peeler
pelador de tomate
éplucheur à tomates



für Links- und Rechtshänder geeignet, ideal für das Schälen von Tomaten, mit 2 beweglichen Klingen

suitable for right and left handed, ideal to peel tomatoes, with 2 flexibles blades
 apto para diestros y zurdos, ideal para pelar tomates, con 2 hojas flexibles
 pour gauchers ou droitiers, idéal pour peler les tomates, 2 lames flexibles

→ cm
 88850 0 16,5



Fischentschupper / Fischschaber „ORANGE“
fish scaler
escamador
écailleur à poisson



zum einfachen Entfernen von Schuppen, ohne die Fischhaut einzureißen

to scale fish easily
 para quitar las escamas con facilidad
 pour ôter facilement les écailles

→ cm
 88852 4 20



Käsehobel „ORANGE“
cheese slicer
rebanador de queso
couteau tranche-fromage



zum Schneiden von dünnen Käsescheiben

to cut thin slices of cheese
 para cortar finas lonchas de queso
 pour couper de fines tranches de fromage

→ cm
 88853 1 21,5



Apfel- / Zwiebelteiler
apple / onion divider
porcionador de manzana -cebolla
coupe-pomme ou oignon en quartiers



stabile Profiausführung, Klingen aus gehärtetem, geschärften Klingenstahl, geeignet für Früchte max. Ø 10 cm

heavy gauge, extra sharpened steel blades, max. Ø 10 cm

aluminio fundido de alta calidad, cuchillas de acero afilado extra max. Diam. 10 cm

fonte d'aluminium, qualité extra, lames inox affûtées, diam. 10 cm

| | □ cm | ↑ cm |
|---------|---------|------|
| 88854 8 | 11 x 17 | 4,5 |



Streichpalette „BLUE“
spatula
espátula
spatule



flexible Edelstahl-Klinge, rutschfester Griff, hitzebeständig

flexible blade stainless steel, non-slip handle, heat-resistant

hoja flexible acero inoxidable mango polipropileno termoresistente anti-deslizante

lame inox flexible, manche anti-glisse en polypropilène thermorésistant



| | □ cm | → cm |
|---------|------------|------|
| 88920 0 | 35 x 5 | 48,5 |
| 88921 7 | 30,5 x 4,5 | 43,5 |
| 88922 4 | 25 x 4 | 38 |
| 88923 1 | 20 x 3 | 33,5 |
| 88924 8 | 15 x 4 | 28 |
| 88925 5 | 15 x 3 | 28 |



Palette „BLUE“
spatula
espátula
spatule



flexible Edelstahl-Klinge, rutschfester Griff, hitzebeständig

flexible blade stainless steel, non-slip handle, heat-resistant

hoja flexible acero inoxidable mango polipropileno termoresistente anti-deslizante

lame inox flexible, manche anti-glisse en polypropilène thermorésistant



| | □ cm | → cm |
|---------|----------|------|
| 88926 2 | 15 x 5,5 | 27 |
| 88927 9 | 17 x 5 | 30,5 |



Winkelpalette „BLUE“
spatula
espátula
spatule

flexible Edelstahl-Klinge
 flexible blade stainless steel
 hoja flexible acero inoxidable
 lame inox flexible



| | cm | → cm |
|---------|--------|------|
| 88928 6 | 17 x 5 | 30 |



Spachtel / Schaber „BLUE“
spatula
paleta triangular
spatule triangulaire

starre Edelstahl-Klinge
 rigid blade stainless steel
 hoja rígida acero inoxidable
 lame inox rigide



| | cm | → cm |
|---------|---------|------|
| 88929 3 | 12 x 10 | 25 |



Gebäckpalette „BLUE“
pastry spatula
paleta pastelera
spatule pâtissière

flexible Edelstahl-Klinge
 flexible blade stainless steel
 hoja rígida acero inoxidable
 lame inox rigide



| | cm | → cm |
|---------|------------|------|
| 88931 6 | 15,5 x 5,5 | 28 |
| 88932 3 | 17 x 7,5 | 29,5 |



Wender „BLUE“
turner
espátula
spatula

flexible Edelstahl-Klinge
 flexible blade stainless steel
 hoja flexible acero inoxidable
 lame inox flexible



| | cm | → cm |
|---------|--------|------|
| 88933 0 | 15 x 6 | 27,5 |
| 88934 7 | 9 x 6 | 19 |



**Winkelpalette „BLUE“
spatula
espátula
spatule**



flexible Edelstahl-Klinge
flexible blade stainless steel
hoja flexible acero inoxidable
lame inox flexible



| | cm | → cm |
|---------|----------|------|
| 88935 4 | 34 x 5 | 47,5 |
| 88936 1 | 29 x 4,5 | 42,5 |
| 88937 8 | 24 x 4 | 36 |
| 88938 5 | 18,5 x 3 | 32 |



**Wender „BLUE“
turner
espátula
spatule large coudée XL**



flexible Edelstahl-Klinge
flexible blade stainless steel
hoja flexible de acero inoxidable
lame flexible inox



| | cm | → cm |
|---------|----------|------|
| 88939 2 | 24 x 7,5 | 37,5 |



**Wender „BLUE“
turner
espátula
spatule**



perforiert, flexible Edelstahl-Klinge
perforated, flexible blade stainless steel
hoja flexible inox agujereada
lame ajourée inox flexible



| | cm | → cm |
|---------|------------|------|
| 88940 8 | 24,5 x 7,5 | 37,5 |



**Wender „BLUE“
turner
espátula para plancha
spatule large coudée**



flexible Edelstahl-Klinge
flexible blade stainless steel
hoja flexible de acero inoxidable
lame flexible inox



| | cm | → cm |
|---------|------------|------|
| 88941 5 | 20 x 7,5 | 33 |
| 88942 2 | 15 x 9 | 28 |
| 88943 9 | 14,5 x 5,5 | 27 |



**Wender „BLUE“
turner
espátula
spatule**



geschlitzt, flexible Edelstahl-Klinge
slotted, flexible blade stainless steel
hoja flexible inox agujereada
lame ajourée inox flexible

| | cm | → cm |
|---------|----------|------|
| 88944 6 | 17 x 8,5 | 30 |



**Spachtel / Fettabstecher „BLUE“
scraper
espátula plancha
spatule coudée spéciale grill**



starre Edelstahl-Klinge
rigid blade stainless steel
hoja rígida de acero inoxidable
lame rigide inox

| | cm | → cm |
|---------|----------|------|
| 88945 3 | 17,5 x 8 | 30 |
| 88946 0 | 17 x 10 | 30 |
| 88947 7 | 15 x 7,5 | 28 |



**Aufstrichmesser „BLUE“
sandwich knife
cuchillo para untar
couteau à tartiner**



flexible Edelstahl-Klinge
flexible blade stainless steel
hoja flexible de acero inoxidable
lame flexible inox

| | cm | → cm |
|---------|---------|------|
| 88948 4 | 8,5 x 3 | 18,5 |



**Pizzaschneider „BLUE“
pizza cutter
cortador de pizza
coupe-pizza**



ergonomischer
ergonomic
mango ergonómico
manche ergonomique

| | cm | → cm |
|---------|------|------|
| 88949 1 | Ø 10 | 20 |



Teigschaber / Abstecher „BLUE“
dough scraper
corta pasta
coupe-pâte



starre Edelstahl-Klinge
 rigid blade stainless steel
 hoja rígida de acero inoxidable
 lame rigide inox

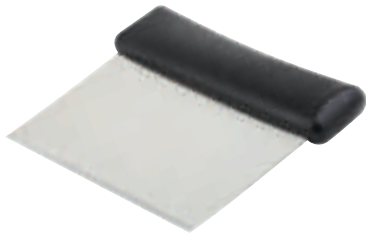

cm
 88930 9 15,5 x 8



Wender „PRO“
turner
espátula
spatule coudée



flexible Edelstahl-Klinge
 flexible blade stainless steel
 hoja inox flexible
 lame inox flexible

cm → cm
 88701 5 12 x 8,7 29



Pizzaschneider „PRO“
pizza cutter
cortador de pizza
coupe-pizza



ergonomischer Griff
 ergonomic handle
 mango ergonómico
 manche ergonomique

cm → cm
 88727 5 Ø 10 25

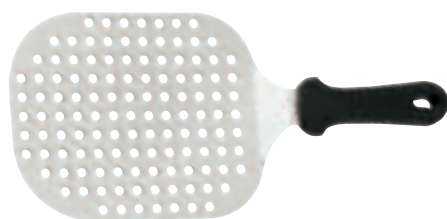

Pizzaheber „PRO“
pizza server
pala pizza
pelle à pizza



geloht, ergonomischer Griff
 perforated, ergonomic handle
 perforada, ergonómica
 perforée, ergonomique

cm → cm
 88631 5 22 x 18 38

STOP-TOOLS designed by formel²³ PRODUKTDISEIGN

Die **STOP**-Funktion verhindert, dass Gabel oder Löffel in das Gefäß rutschen.

The smart **STOP**-function prevent forks and spoon not to slip into the vessel.

La función **STOP** evita que los cubiertos se caigan dentro del recipiente. Antideslizante.

La fonction **STOP** empêche les couverts de glisser dans le récipient.

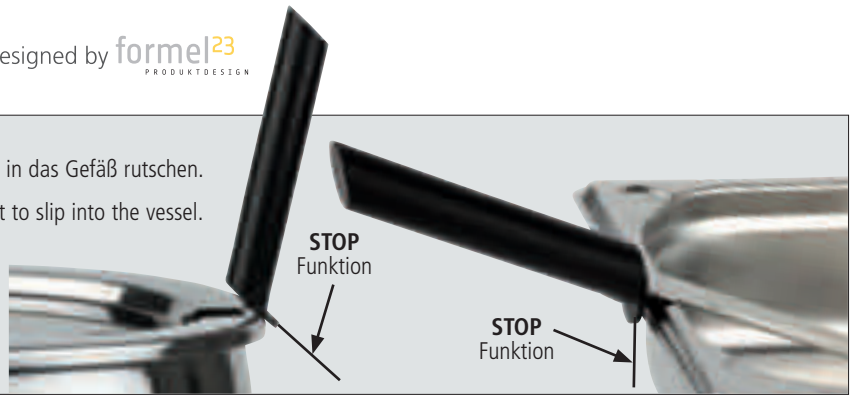

Fleischgabel
meat fork
tenedor de carne
fourchette à viande



Materialdicke 2,5 mm, ergonomischer rutschfester Griff
ergonomic antislip handle
mando ergonómico antideslizante
manche ergonomique anti-dérapant

| | cm | → cm |
|---------|------|------|
| 00831 1 | 10,5 | 38,5 |



Schöpflöffel
ladle
cucharón
louche



Materialdicke 2,5 mm, ergonomischer rutschfester Griff
ergonomic antislip handle
mando ergonómico antideslizante
manche ergonomique anti-dérapant

| | cm | → cm |
|---------|-----|------|
| 00832 8 | Ø 9 | 35 |



Servierlöffel geschlitzt
slotted spoon
cuchara de servicio
cuillère de service



Materialdicke 2,5 mm, ergonomischer rutschfester Griff
ergonomic antislip handle
mando ergonómico antideslizante
manche ergonomique anti-dérapant

| | cm | → cm |
|---------|----------|------|
| 00833 5 | 10 x 7,5 | 37,5 |



Servierlöffel
spoon
cuchara de servicio
cuillère de service



Materialdicke 2,5 mm, ergonomischer rutschfester Griff
ergonomic antislip handle
mando ergonómico antideslizante
manche ergonomique anti-dérapant

| | cm | → cm |
|---------|----------|------|
| 00834 2 | 10 x 7,5 | 37,5 |



Das Profimaterial Polyamid besteht aus Nylon und Fiberglas. Kurzzeitig hitzebeständig bis 220°C, extra hochwertige Profi-Qualität, gut geeignet für antihaftbeschichtete Pfannen, ergonomischer Griff.

Polyamide is made of of nylon and fiberglass. Short term heat-resistant up to 220°C, extra high quality, perfect for non-stick-coated pots and pans, ergonomic handle.

Poliamide de nylon y fibra de vidrio. Brevemente al calor hasta 220°, alta calidad profesional, ideal para sartenes antiadherentes, mango ergonómico.

Polyamide de nylon et fibre de verre, haute résistance brièvement à la chaleur jusque 220°C, qualité professionnelle, idéal pour les poêles anti-adhérentes, manche ergonomique.



Pfannenwender
turner
espátula
spatule



| | cm | → cm | |
|---------|------------|------|---|
| 00600 3 | 11,5 x 9,5 | 35 | ● |



Pfannenwender
turner
espátula
spatule



| | cm | → cm | |
|---------|----------|------|---|
| 00604 1 | 15 x 7,5 | 30 | ● |



Bratenwender
turner
espátula
spatule



| | cm | → cm | |
|---------|----------|------|---|
| 00603 4 | 11 x 9,5 | 35 | ● |



Pfannenwender
turner
espátula
spatule



| | cm | → cm | |
|---------|----------|------|---|
| 88640 7 | 13 x 6,5 | 29 | ● |



Pfannenwender
turner
espátula
spatule



| | cm | → cm | |
|---------|--------|------|---|
| 88642 1 | 14 x 7 | 29 | ● |



Schaumlöffel
skimmer
espumadera
écumoire



| | cm | cm | |
|---------|--------|------|---|
| 00602 7 | Ø 11,5 | 36,5 | ● |



Schöpflöffel
ladle
cucharón
louche



| | cm | cm | |
|---------|-----|----|---|
| 00606 5 | Ø 9 | 32 | ● |



Servierlöffel
spoon
cuchara
cuillère



| | cm | cm | | |
|---------|--------|----|---|------------|
| 88608 7 | 12 x 7 | 35 | ● | |
| 00607 2 | 12 x 7 | 35 | ● | perforiert |



Spaghettizange
spoon
pinza espaguetis
pince universelle ou à spaghettis



| | cm | cm | |
|---------|----|----|---|
| 88637 7 | 9 | 24 | ● |



Salat-Zange
salad tong
pinza ensalada
pince à salade



| | cm | cm | |
|---------|--------|----|---|
| 00605 8 | 10 x 6 | 33 | ● |



Toast-Zange
sandwich tong
pinza para sandwich
pince à toasts



| | cm | cm | |
|---------|--------|----|---|
| 00601 0 | 10 x 8 | 28 | ● |



Schöpflöffel „PROFI“
ladle
cacillo
louche



| | □ cm | → cm | ltr. |
|---------|--------|------|-------|
| 00710 9 | Ø 5 | 32,0 | 0,030 |
| 00711 6 | Ø 6 | 34,0 | 0,050 |
| 00712 3 | Ø 7 | 35,5 | 0,080 |
| 00713 0 | Ø 8 | 38,0 | 0,125 |
| 00714 7 | Ø 9 | 42,0 | 0,150 |
| 00715 4 | Ø 10 | 43,5 | 0,250 |
| 00716 1 | Ø 11 | 45,0 | 0,300 |
| 00717 8 | Ø 14,5 | 48,0 | 0,550 |



Schaumlöffel „PROFI“
skimmer
espumadera
écumoire



| | □ cm | → cm |
|---------|------|------|
| 00720 8 | Ø 8 | 37,0 |
| 00721 5 | Ø 10 | 40,5 |
| 00722 2 | Ø 12 | 46,0 |
| 00723 9 | Ø 14 | 50,5 |



Wender „PROFI“
turner
espátula
spatule



| | □ cm | → cm |
|---------|-----------|------|
| 00730 7 | 10 x 11,5 | 52 |



Servierlöffel „PROFI“
spoon
cuchara
cuillère de service



| | □ cm | → cm |
|---------|----------|------|
| 00672 0 | 10,5 x 7 | 41 |



Servierlöffel geschlitzt „PROFI“
slotted spoon
cuchara de servicio agujereada
cuillère de service ajourée



| | □ cm | → cm |
|---------|----------|------|
| 00671 3 | 10,5 x 7 | 41 |



Spaghettilöffel „PROFI“
spaghetti spoon
cuchara de spaghetti
cuillère à spaghettis



| | □ cm | → cm |
|---------|----------|------|
| 00673 7 | 11 x 6,5 | 39 |



Fleischgabel
meat fork
tenedor de carne
fourchette à viande



| | cm | → cm |
|---------|--------|------|
| 00666 9 | 7 / 10 | 34 |

rutschsichere Griffe, schwarzer Griff,
 hitzebeständig bis 120°C

antislip, black handle,
 heat-resistant up to 120°C

antideslizante, mango negro,
 resiste hasta + 120°C

anti-glisse, manche noir,
 résistant à +120°C



Schöpföffel
ladle
cucharón
louche



| | cm | → cm | ltr. |
|---------|-------|------|------|
| 00670 6 | 9 x 9 | 34 | 0,15 |



Servierlöffel
spoon
cuchara
cuillère



| | cm | → cm |
|---------|----------|------|
| 00662 1 | 10,5 x 7 | 34 |



Servierlöffel gelocht
slotted spoon
cuchara de servicio
cuillère de service



| | cm | → cm |
|---------|----------|------|
| 00664 5 | 10,5 x 7 | 34 |



Bratenwender
slotted turner
espátula para plancha
spatule pour le grill



| | cm | → cm |
|---------|--------|------|
| 00668 3 | 10 x 8 | 36 |

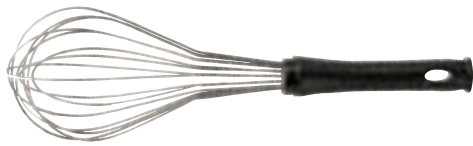

Ballonschneebeesen
whisk
batidor de alambre, bola
fouet ballon



| | → cm | |
|---------|------|--|
| 88706 0 | 35 | 8 Drähte Ø 2 mm / 8 wires Ø 2 mm batidor 8 hilos Ø 2 mm / fouet 8 fils Ø 2 mm |
| 88707 7 | 45 | 8 Drähte Ø 2 mm / 8 wires Ø 2 mm batidor 8 hilos Ø 2 mm / fouet 8 fils Ø 2 mm |

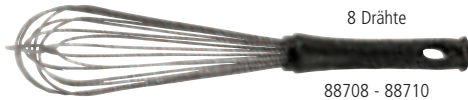

8 Drähte
88708 - 88710

Schneebeesen
whisk
batidor
fouet professionnel



| | → cm | |
|---------|------|---|
| 88708 4 | 35 | 8 Drähte Ø 2,3 mm / 8 wires Ø 2,3 mm batidor 8 hilos Ø 2,3 mm / fouet 8 fils Ø 2,3 mm |
| 88709 1 | 45 | 8 Drähte Ø 2,3 mm / 8 wires Ø 2,3 mm batidor 8 hilos Ø 2,3 mm / fouet 8 fils Ø 2,3 mm |
| 88710 7 | 55 | 8 Drähte Ø 2,3 mm / 8 wires Ø 2,3 mm batidor 8 hilos Ø 2 mm / fouet 8 fils Ø 2 mm |
| 88712 1 | 25 | 11 Drähte Ø 1,5 mm / 11 wires Ø 1,5 mm batidor 11hilos Ø 1,5 mm / fouet 11 fils Ø 1,5 mm |
| 88713 8 | 35 | 11 Drähte Ø 1,5 mm / 11 wires Ø 1,5 mm batidor 11hilos Ø 1,5 mm / fouet 11 fils Ø 1,5 mm |
| 88714 5 | 45 | 11 Drähte Ø 2,5 mm / 11 wires Ø 2,5 mm batidor 11hilos Ø 2,5 mm / fouet 11 fils Ø 2,5 mm |



11 Drähte
88712 - 88714

Tellerschneebeesen
flat whisk
batidor plano
fouet plat

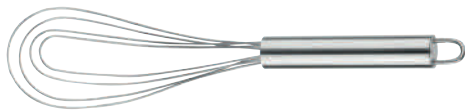

matt poliert, mit Hohlgriff, 4 Drähte
satin polished finish, with hollow handle, 4 wires
inox con cuatro alambres
inox, 4 fils

| | cm | |
|---------|----------|---|
| 73800 3 | 27 x 6,7 | 4 Drähte / 4 wires / 4 hilos / fouet 4 fils |

Schneebeesen
whisk
batidor
fouet

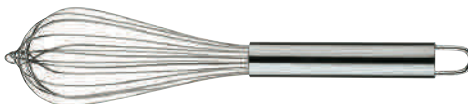

matt poliert, mit Hohlgriff, 8 Drähte
satin polished finish, with hollow handle, 8 wires
inox con mango hueco, 8 hilos
inox, manche creux, 8 fils

| | → cm | |
|---------|------|--|
| 00744 4 | 28 | 8 Drähte Ø 1,5 mm / 8 wires Ø 1,5 mm 8 hilos Ø 1,5 mm / fouet 8 fils Ø 1,5 mm |
| 00745 1 | 33 | 8 Drähte Ø 1,5 mm / 8 wires Ø 1,5 mm 8 hilos Ø 1,5 mm / fouet 8 fils Ø 1,5 mm |
| 00746 8 | 38 | 8 Drähte Ø 1,5 mm / 8 wires Ø 1,5 mm 8 hilos Ø 1,5 mm / fouet 8 fils Ø 1,5 mm |
| 00747 5 | 43 | 8 Drähte Ø 1,5 mm / 8 wires Ø 1,5 mm 8 hilos Ø 1,5 mm / fouet 8 fils Ø 1,5 mm |
| 00740 6 | 48 | 8 Drähte Ø 2,3 mm / 8 wires Ø 2,3 mm 8 hilos Ø 2,3 mm / fouet 8 fils Ø 2,3 mm |

NEW

Kartoffelstampfer XXL
masher
machacador
pilon

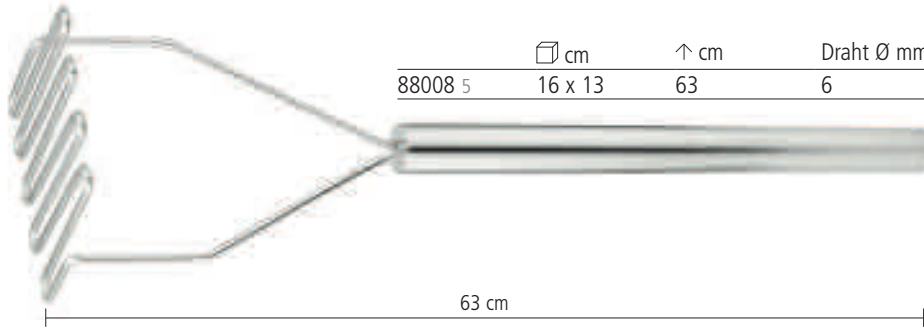

| | cm | cm | Draht Ø mm |
|---------|---------|----|------------|
| 88008 5 | 16 x 13 | 63 | 6 |

Kesselbesen XXL
large whisk
batidor gigante
fouet géant

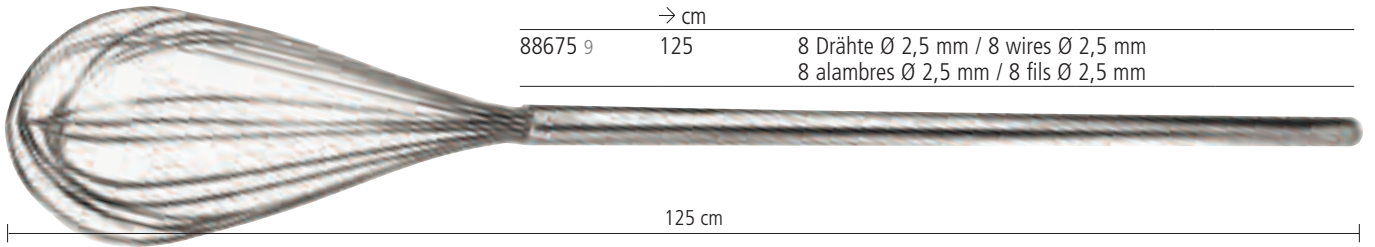

matt poliert / satin polished finish / inox / inox, mat

| | → cm | |
|---------|------|---|
| 88675 9 | 125 | 8 Drähte Ø 2,5 mm / 8 wires Ø 2,5 mm 8 alambres Ø 2,5 mm / 8 fils Ø 2,5 mm |

Back- / Pommes-Frites Schaufel
chip shovel
pala para patatas fritas
pelle à frites



mit geschlossenem Hohlgriff, schwere Qualität
closed hollow handle, heavy gauge
mango hueco cerrado alta calidad
manche creux fermé, qualité extra

| | → cm |
|---------|------|
| 88601 8 | 33 |

Pommes-Frites Abfüll-Schaufel
chip bagger
recogedor para patatas fritas
pelle à frites



matt poliert, Schaufel 23 x 21 cm, Stiel 14 cm
satin polished finish, shovel 23 x 21 cm, handle 14 cm
pulido satinado con asa, 23 x 21 cm, mango de 14 cm
mat, avec anse, 23x21 cm, manche 14 cm

| | |
|---------|---|
| 88019 1 | für Rechtshänder / for right hander para diestros / pour droitiers |
| 88020 7 | für Linkshänder / for left hander para zurdos / pour gauchers |



Eisportionierer
portioner / ice cream scoop
racionador/ cuchara para helado
portionneur à glace



hochglanzpoliert, mit Edelstahlfeder, Feder ist physikalisch bedingt nicht korrosionsbeständig
 mirror polished finish, spring steel, spring is not stainless
 pulido brillante, muelle de acero especial, no resistente al óxido
 poli brillant, ressort acier spécial, non résistant à l'oxydation

| | ∩ cm | → cm | ltr. |
|---------|-------|------|------|
| 71001 6 | Ø 4,5 | 21 | 1/36 |
| 71002 3 | Ø 4,7 | 21,5 | 1/30 |
| 71003 0 | Ø 5,0 | 21,5 | 1/24 |
| 71004 7 | Ø 5,3 | 22 | 1/20 |
| 71005 4 | Ø 5,5 | 22 | 1/16 |
| 71006 1 | Ø 6,5 | 23 | 1/12 |



Eisportionierer
ice cream scoop
cuchara para helado, ovalada
cuillère à glace ovale



hochglanzpoliert, mit Edelstahlfeder, Feder ist physikalisch bedingt nicht korrosionsbeständig,
 Kugel-Größe 5,8 x 4,6 cm

mirror polished finish, spring steel, spring is not stainless, scoop size 5,8 x 4,6 cm

acabado brillante, muelle de acero especial no resistente al óxido, tamaño de la bola 6 x 4,5 cm

brillant, ressort acier spécial, non résistant à l'oxydation, boule 6 x 4,5 cm

| | ∩ cm | → cm | ltr. |
|---------|----------|------|------|
| 71008 5 | 22,5 x 6 | 22,5 | 1/30 |



Spieße / Spießaufhänger
skewer / espetada and kebab skewer rack
soporte para brochetas
support pour brochettes



zum Servieren von Fleischspießen bis 40 cm, Gestell aus 8 mm Edelstahl

to serve skewers up to 40 cm, wire stainless steel 8 mm

para servir brochetas de carne hasta 40 cm, grosor del alambre 8 mm, inox

pour présenter les brochettes long. Maxi 40 cm, fil 8 mm, inox

| | ∩ cm | ↑ cm |
|---------|-------|------|
| 75001 2 | Ø 22 | 46 |
| 75002 9 | Ø 0,3 | 40 |



Messlöffelsatz
set measuring spoon
juego de cucharas medidoras
jeu de cuillère à mesure



Löffel hochglanzpoliert, Stiele matt poliert, Skalierung: 1 Essl., 1 Teel., 1/2 Teel., 1/4 Teel.
 bowl mirror polished finish, handles satin polished finish, measures: table spoon, tea spoon, 1/2 tea spoon, 1/4 tea spoon
 bol medidor brillante, mango mate medidas: 1 cuchara de sopa, 1 cuchara de te, 1/2 cuchara de te, 1/4 cuchara de te.
 corps brillant, manche mat, mesures: 1 cuillerée à soupe, 1 cuillerée à thé, 1/2 cuillère à thé, 1/4 de cuillère à thé,

| | |
|---------|----------|
| | cm |
| 75600 7 | 14 x 4,5 |



Teebrühsieb
snap mesh tea ball
infusor de te, pinza con malla
boule à thé avec pince



matt poliert, mit feinem Sieb, aufklappbar
 satin polished finish, with fine mesh, hinged
 acabado pulido efecto satinado, con malla fina, con bisagra
 inox mat, maille fine, avec charnière

| | | |
|---------|-------|------|
| | cm | → cm |
| 74750 0 | Ø 4,5 | 15,5 |
| 74751 7 | Ø 6,5 | 18 |

Hummerbrecher
lobster cracker
pinza bogavante
pince à homard



| | |
|---------|----------|
| | cm |
| 74201 7 | 14 x 5,5 |



Abbildung Originalgröße



Salatzange
salad serving tong
pinza de ensalada
pince à servir la salade



hochglanzpoliert, einfache Handhabung
 mirror polished finish, convenient handling
 pulido brillante, manejo cómodo
 brillant, manipulation aisée



cm
 00685 0 25 x 6,5



Universalzange
multipurpose tong
pinzas multiusos
pince multi-usages



hochglanzpoliert, einfache Handhabung
 mirror polished finish, convenient handling
 pulido brillante, manejo cómodo
 brillant, manipulation aisée



cm
 00688 1 25 x 6,5



Brot- und Gebäckzange
bread and pastry tong
pinza para pan y bollería
pince à pain ou viennoiseries



hochglanzpoliert, einfache Handhabung
 mirror polished finish, convenient handling
 pulido brillante, manejo cómodo
 brillant, manipulation aisée



cm
 00686 7 25 x 6,5



Brot- und Gebäckzange
bread and pastry tong
pinza para pan y bollería
pince à pain ou viennoiseries



hochglanzpoliert, einfache Handhabung
 mirror polished finish, convenient handling
 pulido brillante, manejo cómodo
 brillant, manipulation aisée



cm
 00687 4 25 x 6,5



Pfannenwender geschlitzt „CLASSIC“
turner
espátula ranurada
spatule rainurée



cm → cm
 75910 7 9 x 8 33



Schaumlöffel „CLASSIC“
skimmer
espumadera
écumoire



hochglanzpoliert, ergonomisch profilierter Hohl-Griff
 mirror polished finish, ergonomic designed handle
 pulido acabado brillante, mango ergonómico
 brillant, manche ergonomique

cm → cm
 75911 4 Ø 11 36



Servierlöffel „CLASSIC“
serving spoon
cuchara de servicio
cuillère de service



hochglanzpoliert, ergonomisch profilierter Hohl-Griff
 mirror polished finish, ergonomic designed handle
 pulido brillante, asa ergonómica.
 brillant, manche ergonomique

cm → cm
 75904 6 9 x 6 32,5



Servierlöffel „CLASSIC“
spoon
cuchara de servir agujereada
cuillère de service ajourée



hochglanzpoliert, perforiert, Löcher Ø 4 mm, ergonomisch profilierter Hohl-Griff
 mirror polished finish, perforated, holes Ø 4 mm, ergonomic designed handle
 pulido brillante agujeros de 4 mm, asa ergonómica
 brillant, trous diam. 4 mm, manche ergonomique

cm → cm
 75903 9 9 x 6 32



Tranchiergabel „CLASSIC“
fork
tenedor para carne
fouchette à viande



hochglanzpoliert, ergonomisch profilierter Hohl-Griff, Zinkenlänge 8 cm
 mirror polished finish, ergonomic designed handle, length of prongs 8 cm
 pulido brillante, asa ergonómica, largo de las puas 8 cm
 brillant, manche ergonomique, dents long. 8 cm

cm → cm
 75905 3 8,5 x 2,5 32



Salatgabel „CLASSIC“
salad fork
tenedor de servicio para ensalada
fourchette de service pour la salade



hochglanzpoliert, ergonomisch profilierter Hohl-Griff
 mirror polished finish, ergonomic designed handle
 pulido brillante, asa ergonómica.
 brillant, manche ergonomique

| | cm | → cm |
|---------|-------|------|
| 75901 5 | 8 x 6 | 30 |



Salatlöffel „CLASSIC“
salad spoon
cuchara para ensalada
cuillère de service pour la salade



hochglanzpoliert, ergonomisch profilierter Hohl-Griff
 mirror polished finish, ergonomic designed handle
 inox brillante, asa ergonómica.
 brillant, manche ergonomique

| | cm | → cm |
|---------|-------|------|
| 75902 2 | 8 x 6 | 30 |



Suppenkelle „CLASSIC“
soup ladle
cucharón de sopa
louche de service



hochglanzpoliert, ergonomisch profilierter Hohl-Griff
 mirror polished finish, ergonomic designed handle
 pulido brillante, asa ergonómica
 brillant, manche ergonomique

| | cm | → cm | ltr. |
|---------|-----|------|------|
| 75907 7 | Ø 7 | 28 | 0,06 |



Suppenkelle „CLASSIC“
soup ladle
cucharón de sopa
louche de service



hochglanzpoliert, ergonomisch profilierter Hohl-Griff
 mirror polished finish, ergonomic designed handle
 pulido brillante, asa ergonómica
 brillant, manche ergonomique

| | cm | → cm | ltr. |
|---------|-----|------|------|
| 75908 4 | Ø 9 | 31 | 0,1 |



Spaghettiheber „CLASSIC“
spaghetti server
tenedor espaguetis
cuillère à spagettis



hochglanzpoliert, ergonomisch profilierter Hohl-Griff
 mirror polished finish, ergonomic designed handle
 acabado brillante, asa ergonómica
 brillant, manche ergonomique

| | cm | → cm |
|---------|---------|------|
| 75909 1 | 8 x 6,5 | 32,5 |



Saucengießlöffel „CLASSIC“
sauce / gravy ladle
cucharón de salsa
cuillère à sauce



hochglanzpoliert, ergonomisch profilierter Hohl-Griff, fugenlos
 mirror polished finish, ergonomic designed handle, seamless
 pulido brillante, asa ergonómica sin soldadura
 brillant, manche ergonomique, monobloc (sans soudure)

| | cm | → cm | ltr. |
|---------|---------|------|------|
| 75906 0 | 7 x 5,5 | 28,5 | 0,02 |



Tortenmesser „CLASSIC“
cake slice
porcionador de pastel
couteau à tarte



eine Kante gezahnt 15,5 cm
 one edge serrated 15,5 cm
 un borde serrado de 15,5 cm
 denté sur un côté

| | cm | → cm |
|---------|---------|------|
| 75912 1 | 4,5 x 1 | 29 |



Tortenheber „CLASSIC“
cake lifter
pala de tartas
pelle à gâteau



hochglanzpoliert, mit einer gezahnten Kante, ergonomisch profilierter Hohl-Griff
 mirror polished finish, one edge serrated, ergonomic designed handle
 pulido brillante, canto dentado, mango ergonómico
 brillant, bord microdenté, manche ergonomique

| | cm | → cm |
|---------|-------|------|
| 75900 8 | 5 x 1 | 23 |



Fischzange
fish tong
pinza de pescado
pince pour le poisson



hochglanzpoliert, längs perforiert
 mirror polished finish, slotted
 pulido brillante
 brillant

| | cm | → cm |
|---------|----------|------|
| 75802 5 | 10,5 x 3 | 24 |



Grillzange
barbecue tong
pinza barbacoa
pince à barbecue



Edelstahl, mit schwarzem kunststoffummanteltem Griff
 black rubber coated handle
 asa revestida de goma negra
 poignée revêtue de résine noire

| | cm | → cm |
|---------|---------|------|
| 75817 9 | 8 x 3,5 | 30,5 |



Gebäck- / Tortenzange
pastry tong
pinza para pasteles
pince à gâteaux



hochglanzpoliert, fugenlos
 mirror polished finish, seamless
 acabado brillante, sin soldadura
 brillant, monobloc

| | cm | → cm |
|---------|---------|------|
| 75803 2 | 7 x 3,5 | 17,5 |



Gebäckzange
pastry tong
pinza para pasteles
pince à gâteaux



hochglanzpoliert, perforiert
 mirror polished finish, perforated
 pulido brillante, perforado
 brillant, perforée

| | cm | → cm |
|---------|---------|------|
| 75804 9 | 6,5 x 3 | 19,5 |



HOT PRICE

Eiszange
ice cube tong
pinza de hielo
pince à glaçons



hochglanzpoliert, fugenlos
 mirror polished finish, seamless
 pulido acabado brillante, de una sola pieza
 brillant, d'une seule pièce

| | cm | → cm |
|---------|-------|------|
| 75805 6 | 5 x 2 | 17,5 |



Allzweckzange
multipurpose tong
pinza multi-usos
pince universelle multi-usages



| | cm | → cm |
|---------|-------|------|
| 88643 8 | 4 x 3 | 24 |
| 88644 5 | 4 x 3 | 30 |
| 88645 2 | 4 x 3 | 40 |



Aufschnitt- / Allzweckzange
sausage tong
pinza salchichas
pince à saucisses



hochglanzpoliert, fugenlos
mirror polished finish, seamless
pulido brillante, sin soldadura
brillant, monobloc

| | cm | → cm |
|---------|---------|------|
| 75806 3 | 3 x 2,5 | 16 |



Gebäckzange
pastry tong
pinza para pasteles
pince à gâteaux



hochglanzpoliert, fugenlos, extra schwere Qualität
mirror polished finish, seamless, extra heavy gauge
pulido brillante, sin soldadura, alta calidad resistente.
brillant, monobloc, qualité extra, robuste

| | cm | → cm |
|---------|---------|------|
| 75807 0 | 8,5 x 4 | 27,5 |



Universalzange
general tong
pinza universal
pince universelle



hochglanzpoliert, einseitig geschlitzt
mirror polished finish, slotted on one side
acabado brillante, agujereada en un lado
brillant, perforée d'un seul côté

| | cm | → cm |
|---------|-------|------|
| 75800 1 | 5 x 2 | 24 |



Salatzange
salad tong
pinza ensalada
pince à saladeç



hochglanzpoliert, beidseitig geschlitzt
mirror polished finish, slotted on both side
acabado brillante, agujereada en 2 lados
brillant, perforéedes 2 côtés

| | cm | → cm |
|---------|-------|------|
| 75801 8 | 5 x 2 | 24 |



Spaghettizange
spaghetti tong
pinza espaguettis
pince à spaghettis



hochglanzpoliert, fugenlos
 mirror polished finish, seamless
 acabado brillante sin soldaduras
 brillant, monobloc

| | cm | → cm |
|---------|-------|------|
| 75810 0 | 6 x 3 | 19 |

ideal zum Grätzenziehen
 oder Garnieren
 von edlen Speisen



Pinzettenzange
fine tong / tweezer
pinza de emplatar
pince à dresser



hochglanzpoliert, geriffelte Grifffläche, abgerundete Spitzen vorne, schwere Qualität
 mirror polished finish, ribbed handle, rounded on the tops, heavy gauge
 acabado brillante, mango cómodo ranurado, alta calidad, puntas redondeadas
 brillant, manche rainuré anti-glisse, qualité extra, pointes arrondies

| | cm | → cm |
|---------|-------|------|
| 75808 7 | 1 x 1 | 14,5 |

ideal zum Garnieren
 und Dekorieren
 von edlen Speisen



Pinzettenzange
fine tong / tweezer
pinza de emplatar
pince à dresser



hochglanzpoliert, geriffelte Grifffläche, schwere Qualität
 mirror polished finish, ribbed handle, heavy gauge
 acabado brillante, mango cómodo ranurado, alta calidad
 brillant, manche rainuré anti-glisse, qualité extra

| | cm | → cm |
|---------|---------|------|
| 75809 4 | 1,5 x 1 | 30 |



Zitronenschnitzpresse
lemon slice squeezer
pinza exprimelimón
pince presse-citron



hochglanzpoliert, zum Auspressen von Zitronenscheiben
 mirror polished finish, to press lemon slices
 pulido brillante para rodajas de limón
 brillant, pour citrons en rondelle

| | cm |
|---------|-------|
| 71430 4 | 8 x 7 |

NEW



93195



93196

Mehrzweckschaufel
scoop
pala universal
pelle multi-usages



| | cm | → cm |
|---------|-----|------|
| 93195 4 | Ø 6 | 24 |
| 93196 1 | Ø 8 | 26 |

Eis- / Mehrzweckschaufel
scoop
pala universal
pelle multi-usages



hochglanzpoliert, Hohlgriff, fugenlos verbunden mit Schaufel, extra schwere Qualität
mirror polished finish, hollow handle, seamless fixed, extra heavy gauge
brillante, mango hueco, sin soldadura con gancho, muy resistente
brillant, manche creux, monobloc, avec crochet, très robuste

| | cm | → cm | ltr. |
|---------|------------|------|------|
| 71009 2 | 8,5 x 4,3 | 17,5 | 0,05 |
| 71010 8 | 9,5 x 5,9 | 21,5 | 0,07 |
| 71011 5 | 12 x 6 | 23 | 0,14 |
| 71012 2 | 14 x 7,5 | 23,5 | 0,24 |
| 71013 9 | 15,5 x 8,5 | 24,5 | 0,30 |
| 71014 6 | 18 x 10 | 29 | 0,36 |
| 71015 3 | 22 x 13 | 35 | 0,47 |

Mehlschaufel
scoop
pala
pelle à farine



stehende Schaufel, auch für Flüssigkeiten geeignet
standing scoop, also applicable for liquids
pala, ápto también para líquidos
adaptée pour poudres et liquides

| | cm | ↑ cm | ltr. | |
|---------|---------|------|------|---|
| 00610 2 | 25 x 9 | 4,5 | 0,25 | ○ |
| 00611 9 | 31 x 12 | 5,5 | 0,5 | ○ |
| 00612 6 | 35 x 13 | 6 | 0,7 | ○ |

Eisschaufel
ice scoop
pala de hielo
pelle à glaçons



| | cm | → cm | ltr. | |
|---------|--------|------|------|---|
| 93192 3 | 10 x 6 | 29 | 0,7 | ● |

HOT PRICE



Feinkostlöffel, 6er Set
delicatessen spoon, 6 pcs. set
juego de 6 cucharas gourmet
jeu de 6 cuillères gourmet



| | cm | → cm | pcs. |
|---------|-----|------|------|
| 88626 1 | ∅ 6 | 23 | 6 |

HOT PRICE



Feinkostlöffel, 6er Set
delicatessen spoon, 6 pcs. set
juego de 6 cucharas gourmet
jeu de 6 cuillères gourmet



| | cm | → cm | pcs. |
|---------|-----|------|------|
| 88627 8 | ∅ 6 | 23 | 6 |

HOT PRICE



Feinkostlöffel, 6er Set
delicatessen spoon, 6 pcs. set
juego de 6 cucharas gourmet
jeu de 6 cuillères gourmet



| | cm | → cm | pcs. |
|---------|-----|------|------|
| 88628 5 | ∅ 6 | 23 | 6 |

HOT PRICE



Feinkost- / Olivenlöffel, 6er Set
delicatessen / oliven spoon, 6 pcs. set
juego de 6 cucharas para olivas
jeu de 6 cuillères à olives



geloct
perforated
perforadas
perforées

| | cm | → cm | pcs. |
|---------|-------|------|------|
| 88598 1 | 6 x 9 | 27 | 6 |

HOT PRICE



Dressinglöffel
dressing spoon
cuchara de aliño
cuillère à sauce



| | cm | → cm | pcs. |
|--------------------|-----|------|------|
| 88609 4 | ∅ 6 | 34 | ● |
| NEW 88636 0 | ∅ 6 | 34 | ○ |

designed by **CULTURE FORM**



84020



84021



Servierlöffel „PROFI“
serving-spoon
cuchara
cuillère



| | cm | → cm | |
|---------|---------|------|---|
| 84020 1 | 7 x 6,5 | 26,5 | ○ |
| 84021 8 | 7 x 6,5 | 26,5 | ● |



rutschsicher /
slip-proof



gerade
Portionierkante /
easy cutting



einfach abstreifen /
simply wipe off



Tiefe Ecken? - Kein Problem!
Deep corners? No problem!

EAN = 40 04 133 XXXXX X

QUALITÄTSHAUBEN designed by sieger design



NEW

PROFI-QUALITY

2 Größen / 2 sizes



3mm Materialstärke

Frischhalte-Haube
cover
campana
cloche bombée



glasklar, Griff verchromt, schwere stabile Ausführung
transparent, chrome knob, heavy stable quality
transparent, asa cromada, alta estabilidad
transparente, ansa cromée, très stable

| | □ cm | ↑ cm | matches |
|---------|--------|------|-----------------------------------|
| 15350 9 | Ø 16,5 | 10 | 15130 |
| 15351 6 | Ø 20,5 | 10 | 15131, 15141, 15136, 15271, 84241 |



passendes Tablett
15130

passender Ständer
15311, 15313

Rolltop-Haube
rolltop cover
campana abatible
cloche basculante



glasklarer Kunststoff, leichtgängig auf- und zuklappen 90°
 solid quality, to be opened 90°
 plástico transparente de alta calidad, apertura a 90°
 plastique transparent résistant, ouverture 90°

passend für alle APS-Tablets mit Ø 38 cm
suitable for APS trays Ø 38 cm
apta para todas las bandejas APS de Ø 38 cm
adequada para todas as bandejas APS com Ø 38 cm

| | □ cm | ↑ cm | |
|---------|------|------|--|
| 18387 2 | Ø 38 | 20 | mit vergoldetem Kugelgriff gold plated handle pomo dorado bouton doré |
| 18388 9 | Ø 38 | 20 | mit verchromtem Kugelgriff chrome plated handle pomo cromado bouton chromé |



| | □ cm | ↑ cm | |
|---------|------|------|---|
| 18380 3 | Ø 50 | 26 | mit verchromtem Zylindergriff chrome plated handle pomo cromado bouton chromé |
| 18381 0 | Ø 50 | 26 | mit verchromtem Kreuzgriff chrome plated handle pomo cromado bouton chromé |
| 18383 4 | Ø 50 | 26 | mit vergoldetem Kreuzgriff gold plated handle pomo dorado bouton doré |



designed by **CULTURE FORM**

Rolltop-Haube „PURE“
rolltop cover
campana abatible
cloche basculante



PATENT



verchromter Griff
chrome plated handle
pomo cromado
bouton chromé

| | ▣ cm | ↑ cm |
|---------|-----------|------|
| 09013 2 | 44 x 33,5 | 17 |

Rolltop-Haube GN1/1
rolltop cover
campana rolltop
cloche rolltop



PATENT



GN1/1 oder GN1/2

patentiert, passend für GN-Behälter, -Tablets, etc., leichtgängig auf- und zuklappbar 90°, temperaturbeständig -30°C bis ca. 120°C

patented, suitable for GN trays, solid quality, 90° opening, heat-resistant -30°C to 120°C

patentada, pomo dorado, apertura 90°, temperatura -30°C a +120°C

brevetée, bouton doré, ouverture 90°, température -30°C à +120°C

| | ▣ cm | ↑ cm | |
|---------|-------------|------|--|
| 11008 3 | 53 x 32,5 | 19 | vergoldeter Griff / gold plated handle pomo dorado / bouton doré GN 1/1 |
| 11010 6 | 53,0 x 32,5 | 19 | verchromter Griff / chrome plated handle pomo cromado / bouton chromé GN 1/1 |
| 12008 2 | 32,5 x 26,5 | 15 | vergoldeter Griff / gold plated handle pomo dorado / bouton doré GN 1/2 |
| 12010 5 | 32,5 x 26,5 | 15 | verchromter Griff / chrome plated handle pomo cromado / bouton chromé GN 1/2 |

designed by **KIRCHHOFF & EUWENS**

Rolltop-Haube GN1/1 „SUNDAY“
rolltop cover GN 1/1
campana rolltop GN 1/1
cloche rolltop GN 1/1



PATENT



patentiert, mit Designer-Griff, ABS verchromt, leichtgängig auf- und zuklappbar

patent, with designer handle, chrome plated, easy to open and close

campana sola, policarbonato, asa cromada, fácil de abrir y cerrar

cloche seule, polycarbonate, bouton chromé, ouverture et fermeture faciles

| | ▣ cm | ↑ cm | GN |
|---------|-----------|------|-----|
| 11016 8 | 53 x 32,5 | 19 | 1/1 |

Haube GN1/1
cover
campana GN 1/1
cloche GN 1/1

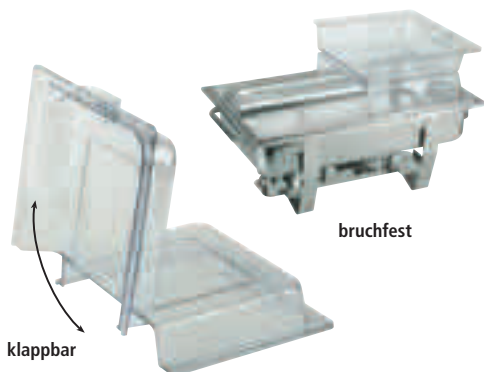

bruchfest

klappbar

klappbar, passend für GN1/1-Behälter, GN1/1-Tablets, etc., nahezu bruchfest

suitable for GN1/1 chafing dish, GN1/1 trays, GN1/1 pans

para chafing dish GN 1/1, bandejas GN 1/1, cubetas GN 1/1

pour chafing dish, plateau, bac ou corbeille GN 1/1

| | ▣ cm | ↑ cm | GN |
|---------|-----------|------|-----|
| 11013 7 | 53 x 32,5 | 6 | 1/1 |



Ø 30 cm
und
Ø 33 cm



Frishalte-Haube
cover
campana
cloche



glasklar, schwere stabile Ausführung
clear, heavy stable quality, stackable
transparente, alta estabilidad, apilable
transparente, très stable, empilable

| | ☐ cm | ↑ cm | |
|---------|------|------|--|
| 06510 9 | Ø 30 | 11,5 | |
| 06511 6 | Ø 30 | 11,5 | schwarzer Griff / black handle botón negro / bouton noir |
| 06512 3 | Ø 30 | 11,5 | mit verchromtem Griff chrom plated handle botón cromado bouton chromé |
| 06515 4 | Ø 33 | 12,5 | |
| 06516 1 | Ø 33 | 12,5 | schwarzer Griff / black handle botón negro / bouton noir |
| 06517 8 | Ø 33 | 12,5 | mit verchromtem Griff chrom plated handle botón cromado bouton chromé |



stapelbar



Frishalte-Haube
cover
campana
cloche



| | ☐ cm | ↑ cm |
|---------|------|------|
| 06501 7 | Ø 30 | 11 |
| 06504 8 | Ø 30 | 9,5 |
| 06506 2 | Ø 30 | 7 |



Frishaltehauben, 2er Set
covers, 2 pcs. set
2 campanas
set de 2 cloches



vielseitig einsetzbar, einzeln mit Farbbänderole
multifunctional usable
uso multifunción, -40° hasta + 95°C
multi-usages, -40° à + 95°C

| | ☐ cm | ↑ cm |
|---------|------|------|
| 40752 7 | Ø 30 | 11 |



GN Kuppelhaube
GN cover
GN cúpula
GN cloche bombée



glasklarer Kunststoff, Griff verchromt
 clear, chrome knob
 transparente, asa cromada
 transparente, anse chromée

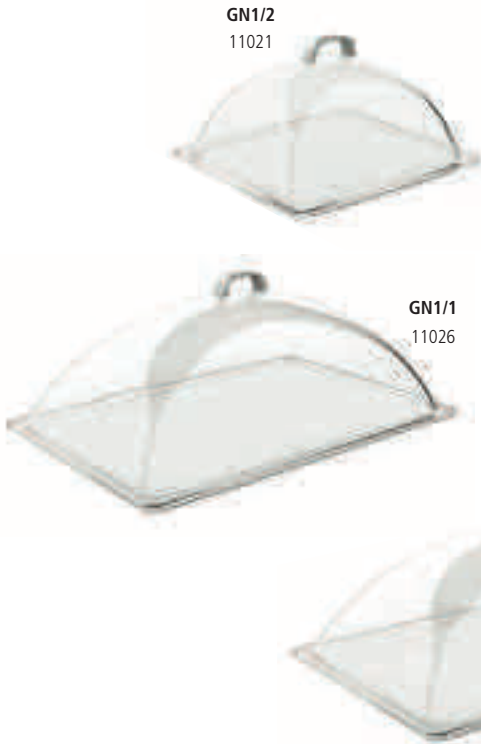

| | □ cm | ↑ cm | |
|------------------|---------|------|--|
| 11021 2 GN1/2 | 33 x 28 | 17 | geschlossen / totally closed cerrada / tolement fermée |
| 11022 9 GN1/2 | 33 x 28 | 17 | mit Front-Ausschnitt / one long side cut out gran apertura frontal / grande ouverture frontale |
| 11026 7 GN1/1 | 54 x 33 | 20 | geschlossen / totally closed cerrada / tolement fermée |
| 11027 4 GN1/1 | 54 x 33 | 20 | mit Front-Ausschnitt / one long side cut out gran apertura frontal / grande ouverture frontale |
| 11028 1 GN1/1 | 54 x 33 | 20 | mit seitlichem Ausschnitt / one small side cut out pequeña apertura frontal / petite ouverture frontale |



Abdeckhaube GN
cover GN
cubierta GN
cloche GN



passend für GN Tablett, glasklarer Kunststoff, nahezu unzerbrechlich
 suitable for GN trays, clear plastic, nearly unbreakable
 apto para bandejas GN, plástico transparente, muy resistente a la rotura, resistencia hasta 60°C
 pour bacs et plateaux GN, plastique transparent, très résistant à la casse, température maxi +60°C

| | □ cm | ↑ cm | GN |
|-------------------|-------------|------|-----|
| 11001 4 GN 1/2 | 32,5 x 26,5 | 9,5 | 1/2 |
| 11003 8 GN 1/1 | 53 x 32,5 | 9,5 | 1/1 |



Haube GN 1/1 „HOCHSTAPLER“
cover GN 1/1 high stacker
campana GN 1/1 especial para apilar
cloche GN 1/1 spéciale empilage



glasklarer Kunststoff, passend zum Tablett 11300, 11290, 11295, Tablett fixiert sich auf der Haube - kein Rutschen möglich, nahezu bruchfest
 clear plastic, for tray 11300, 11290, 11295, tray fixes itself on the cover and can not slip off, nearly unbreakable
 plástico transparente para bandejas 11300, 11290, 11295, la bandeja se fija a la tapa para que no se deslice, muy resistente a la rotura
 en plastique transparent pour plats 11300, 11290, 11295. Le plat se fixe sur le dessous de la cloche pour ne pas glisser, très résistant à la casse

| | □ cm | ↑ cm | GN |
|---------|-----------|------|-----|
| 11305 3 | 53 x 32,5 | 9 | 1/1 |

NEW

**Deckel „PURE“, mit Löffelaussparung
cover, with notched for spoons
tapa, con espacio para la cuchara
couvreclle, avec encoche pour la louche**



| | □ cm | ↑ cm | matches |
|---------|---------|------|--|
| 83600 6 | 19 x 19 | 1,5 | Schale / bowls „PURE“ 84410, 84417, 84422, 83409 83572, 83468, 83573, 84429 |
| 83601 3 | 25 x 25 | 1,5 | Schale / bowls „PURE“ 84408, 84418, 84423, 83469, 83574, 83575, 83408, 84430 |

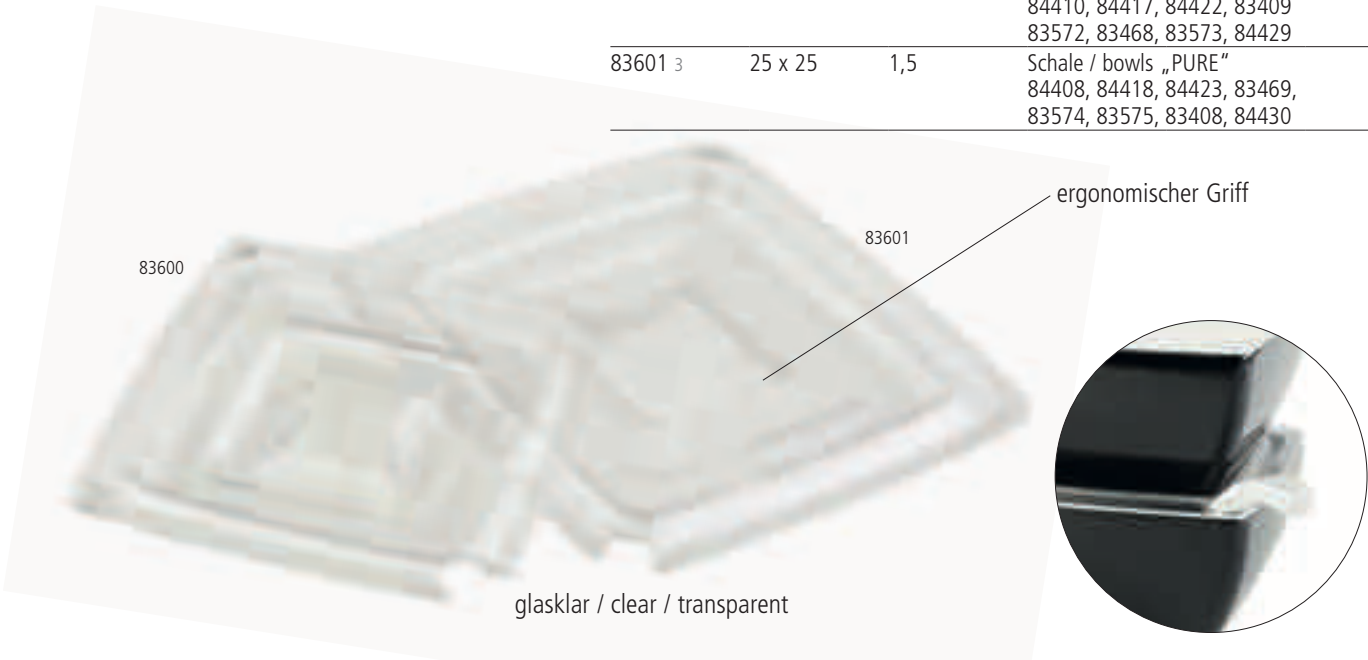

**Frischhaltedeckel
airtight cover
tapa hermética
couvreclle hermétique**



mit Silikondichtung, für luftdichtes Verschließen, Lebensmittel bleiben lange frisch
with silicone sealing ring, bowls closed airtight, to keep food fresh for a long time
junta de silicona para cerrar herméticamente los boles y mantener los alimentos frescos más tiempo
joint silicone pour fermeture hermétique et meilleure conservation des aliments



| | □ cm |
|---------|--|
| 10890 5 | Ø 14 passend für Schalen 11865, 83700, 83701 suitable for bowls 11865, 83700, 83701 disponible para boles 11865, 83700, 83701 disponible pour bols 11865, 83700, 83701 |
| 10887 5 | Ø 23 passend für Schalen 11875, 11846, 11848, 83702, 83703 suitable for bowls 11875, 11846, 11848, 83702, 83703 disponible para boles 11875, 11846, 11848, 83703 disponible pour bols 11875, 11846, 11848, 83703 |

designed by **KIRCHHOFF & EUWENS**

**Deckel klappbar
cover hinged
tapa con bisagra
couvreclle avec charnière**



glasklar, mit Designer-Griff, verchromt, ohne Beschriftungsschild
clear, with designer handle, chrome plated, without card for inscription
transparente con pomo de diseño cromado sin tarjetas para inscripción
transparent, avec bouton chromé de design, sans étiquette pour inscription



| | □ cm |
|---------|--------|
| 10889 9 | Ø 23,5 |

EAN = 40 04 133 XXXXX X

461

Zubehör
spare parts

Schutzdeckel
cover
tapa
couvercle



glasklar, klappbar, mit Beschriftungs-Schild
transparent, with card for inscription
plástico transparente, con etiqueta para inscripción
plastique transparent, avec étiquette pour inscription



in 2 Größen lieferbar

| | cm | |
|---------|--------|---|
| 11867 6 | Ø 14,5 | mit vergoldetem Griff / gold plated handle botón dorado / bouton doré |
| 11868 3 | Ø 14,5 | mit verchromtem Griff / chrome plated handle botón cromado / bouton chromé |
| 11877 5 | Ø 23,5 | mit vergoldetem Griff / gold plated handle botón dorado / bouton doré |
| 11878 2 | Ø 23,5 | mit verchromtem Griff / chrome plated handle botón cromado / bouton chromé |

Einzelteile / spare parts / piezas sueltas / pièces détachées

passende Schilder, 10er Set / fitting signs, 10 pcs. set
set de 10 cartelitos / set de 10 étiquettes

| | |
|---------|--|
| 11879 9 | für große Deckel / for big covers para tapas grandes / pour grands couvercles |
| 12879 8 | für kleine Deckel / for small covers para tapas pequeñas / pour petits couvercles |



Schale
bowl
bol
bol



| | cm | ↑ cm | litr. |
|---------|-------|------|-------|
| 11859 1 | Ø 6 | 2,5 | 0,05 |
| 11865 2 | Ø 14 | 6,5 | 0,5 |
| 11866 9 | Ø 7,5 | 3,5 | 0,09 |
| 11875 1 | Ø 23 | 10,5 | 2,5 |

Kühlakku
cooler
acumulador de frío
accumulateur de froid



gefüllt mit Kühlflüssigkeit, nicht giftig, einfach im Gefrierfach einfrieren, unbegrenzt wiederverwendbar

freeze it in freezer, non toxic, filled with freezer-liquid, boundless reusable

se enfría en el congelador, no tóxico, se puede reutilizar sin límite

liquide eutectique qui accumule froid une fois dans le congélateur, non toxique, réutilisable sans limites

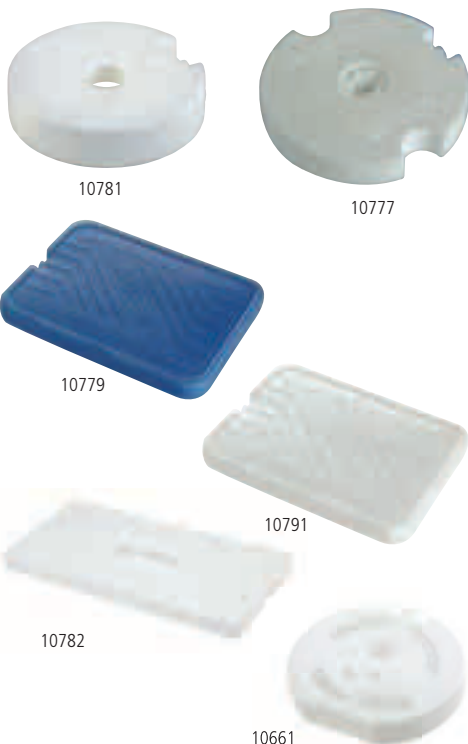

| | cm | ↑ cm | |
|---------|---------|------|---|
| 10777 9 | Ø 15 | 2,5 | ○ |
| 10779 3 | 25 x 19 | 2,5 | ● |
| 10791 5 | 25 x 19 | 2,5 | ○ |
| 10781 6 | Ø 10,5 | 2,5 | ○ |
| 10782 3 | 41 x 21 | 2,5 | ○ |
| 10661 1 | Ø 10,5 | 2,0 | ○ |

ohne Abbildungen / without pictures / no fotografiado / fotos não estão disponíveis

| | cm | ↑ cm | pcs. | |
|---------|----------|------|------|---|
| 11101 1 | 16 x 7,5 | 2,0 | 4 | ● |
| 10752 6 | Ø 10,5 | 2,0 | | ● |

Index

0

| | | | | | | | | | | | | | | | |
|-------|----------|-------|---------------|-------|---------------|-------|----------|-------|-----------------|-------|---------------|-------|----------|-------|---------------|
| 00013 | 329 | 00395 | 139 | 00692 | 242 | 01311 | 137 | 06510 | 100, 142, | 10773 | 226 | 11230 | 191 | 11699 | 252 |
| 00015 | 397 | 00396 | 139 | 00700 | 333 | 01312 | 137 | | 146, 417, 459 | 10774 | 226 | 11244 | 259 | 11720 | 392 |
| 00016 | 397 | 00397 | 139 | 00710 | 287, 439 | 01313 | 137 | 06511 | 100, 459 | 10775 | 227 | 11252 | 133 | 11730 | 393 |
| 00017 | 329 | 00398 | 139 | 00711 | 287, 439 | 01314 | 137 | 06512 | 23, 25, 43, | 10776 | 227 | 11290 | 133, 282 | 11762 | 393 |
| 00019 | 395 | 00399 | 139 | 00712 | 287, 439 | 01317 | 137 | | 100, 459 | 10777 | 165, 216, | 11295 | 131 | 11763 | 393 |
| 00020 | 395 | 00401 | 369 | 00713 | 287, 439 | 01318 | 137 | 06515 | 70, 142, 459 | | 218, 237, 462 | 11300 | 133, 282 | 11765 | 393 |
| 00021 | 333 | 00444 | 146 | 00714 | 287, 439 | 01322 | 137 | 06516 | 70, 459 | 10778 | 194 | 11302 | 134 | 11766 | 393 |
| 00022 | 331 | 00462 | 147, 417 | 00715 | 287, 439 | 01323 | 137 | 06517 | 25, 29, 43, 70, | 10779 | 210, 211, | 11305 | 134, 460 | 11775 | 390 |
| 00023 | 333 | 00463 | 146, 417 | 00716 | 287, 439 | 01324 | 137 | | 146, 417, 459 | | 212, 214, 462 | 11310 | 133 | 11776 | 390 |
| 00024 | 396 | 00464 | 146 | 00717 | 287, 439 | 01325 | 137 | 06701 | 148 | 10781 | 165, 462 | 11312 | 282 | 11777 | 392 |
| 00025 | 395 | 00465 | 148, 418 | 00720 | 287, 439 | 01328 | 144 | 09000 | 203 | 10782 | 191, 462 | 11315 | 282 | 11778 | 392 |
| 00026 | 395 | 00466 | 146, 417 | 00721 | 287, 439 | 01329 | 144 | 09001 | 203 | 10788 | 228 | 11319 | 282 | 11780 | 392 |
| 00027 | 395 | 00468 | 100, 147, 418 | 00722 | 287, 439 | 01332 | 137 | 09002 | 203 | 10789 | 228 | 11395 | 172 | 11794 | 191 |
| 00028 | 395 | 00469 | 100, 147, 418 | 00723 | 287, 439 | 01335 | 137 | 09003 | 203 | 10791 | 203, 462 | 11396 | 172 | 11795 | 191 |
| 00029 | 395 | 00500 | 155 | 00730 | 287, 439 | 01336 | 145, 308 | 09010 | 203 | 10793 | 233 | 11397 | 172 | 11805 | 193 |
| 00030 | 332 | 00501 | 155 | 00740 | 441 | 01337 | 156, 308 | 09011 | 203 | 10794 | 233 | 11398 | 172 | 11807 | 193 |
| 00031 | 398 | 00502 | 155 | 00744 | 441 | 01338 | 137 | 09012 | 203 | 10795 | 233 | 11399 | 172 | 11808 | 193, 196 |
| 00032 | 151 | 00503 | 155 | 00745 | 441 | 01348 | 137 | 09013 | 203, 458 | 10796 | 233 | 11400 | 129 | 11810 | 217 |
| 00033 | 387 | 00505 | 155 | 00746 | 441 | 01349 | 137 | 09016 | 203 | 10797 | 233 | 11410 | 129 | 11811 | 217 |
| 00034 | 331 | 00506 | 155 | 00747 | 441 | 01358 | 137 | 09020 | 203 | 10798 | 233 | 11421 | 197 | 11812 | 217 |
| 00036 | 332 | 00507 | 155 | 00765 | 378 | 01415 | 130 | 09021 | 203 | 10799 | 233 | 11422 | 197 | 11813 | 217 |
| 00037 | 331 | 00508 | 155 | 00766 | 378 | 01416 | 130 | 09022 | 203 | 10800 | 229 | 11423 | 197 | 11815 | 217 |
| 00038 | 330 | 00510 | 154 | 00768 | 378 | 01420 | 130 | 09023 | 203 | 10801 | 237 | 11424 | 197 | 11816 | 217 |
| 00039 | 330 | 00511 | 154 | 00770 | 402 | 01425 | 130 | 09026 | 203 | 10803 | 237 | 11426 | 197 | 11817 | 216 |
| 00040 | 415 | 00512 | 154 | 00771 | 402 | 01437 | 129 | 09080 | 206 | 10804 | 237 | 11427 | 197 | 11818 | 216 |
| 00042 | 415 | 00513 | 154 | 00772 | 384 | 01699 | 160 | 09081 | 207 | 10805 | 231, 232 | 11431 | 197 | 11833 | 195 |
| 00043 | 326 | 00515 | 154 | 00773 | 383 | 01709 | 141 | 09082 | 215 | 10806 | 231, 232 | 11432 | 197 | 11834 | 195 |
| 00044 | 326 | 00520 | 157 | 00774 | 383 | 01710 | 141 | 09083 | 215 | 10807 | 237 | 11433 | 197 | 11845 | 218 |
| 00045 | 418 | 00521 | 157 | 00775 | 383 | 01711 | 141 | 09085 | 206 | 10808 | 237 | 11434 | 197 | 11846 | 216, 218 |
| 00046 | 147, 418 | 00522 | 157 | 00776 | 383 | 01712 | 141 | 09090 | 208 | 10809 | 237 | 11435 | 197 | 11847 | 218 |
| 00048 | 326 | 00523 | 157 | 00777 | 383 | 01723 | 141 | 09093 | 209 | 10810 | 237 | 11436 | 197 | 11848 | 216, 218 |
| 00049 | 326 | 00524 | 157 | 00778 | 383 | 01725 | 141 | 09099 | 206 | 10812 | 237 | 11437 | 197 | 11849 | 218 |
| 00050 | 326 | 00525 | 157 | 00779 | 384 | 01738 | 141 | 09100 | 208 | 10814 | 237 | 11438 | 197 | 11859 | 462 |
| 00052 | 326 | 00526 | 157 | 00780 | 408 | 01748 | 141 | 09102 | 208 | 10820 | 230 | 11439 | 197 | 11865 | 189, 462 |
| 00054 | 325 | 00527 | 157 | 00785 | 403 | 02038 | 398 | 09104 | 208 | 10825 | 234 | 11442 | 198 | 11866 | 462 |
| 00055 | 325 | 00528 | 157 | 00831 | 286, 436 | 02310 | 141 | 09200 | 209 | 10830 | 235 | 11444 | 198 | 11867 | 189, 462 |
| 00058 | 398 | 00529 | 157 | 00832 | 286, 436 | 02311 | 141 | 09202 | 209 | 10833 | 235 | 11446 | 199 | 11868 | 189, 217, 462 |
| 00059 | 387 | 00530 | 155 | 00833 | 286, 436 | 02312 | 141 | 09204 | 209 | 10835 | 235 | 11447 | 198 | 11875 | 188, 218, 462 |
| 00060 | 329 | 00531 | 155 | 00834 | 286, 436 | 03010 | 342 | 09923 | 87 | 10840 | 234 | 11449 | 198 | 11877 | 188, 462 |
| 00062 | 150 | 00532 | 155 | 00860 | 136, 144, 204 | 03012 | 341 | 09924 | 87 | 10850 | 234 | 11451 | 199 | 11878 | 188, 216, |
| 00063 | 150 | 00533 | 155 | 00861 | 136, 204 | 03013 | 340 | | | 10859 | 234 | 11455 | 199 | | 218, 462 |
| 00064 | 148 | 00535 | 155 | 00862 | 136, 204 | 03014 | 340 | 1 | | 10860 | 231 | 11456 | 199 | 11879 | 109, 329, |
| 00065 | 148 | 00536 | 155 | 00863 | 136, 204 | 03015 | 340 | 10316 | 386 | 10862 | 232 | 11470 | 129 | | 330, 462 |
| 00066 | 148 | 00537 | 155 | 00865 | 113, 205 | 03016 | 341 | 10317 | 386 | 10864 | 232 | 11475 | 129 | 11881 | 420 |
| 00070 | 334 | 00538 | 155 | 00866 | 113, 205 | 03017 | 341 | 10318 | 386 | 10865 | 231 | 11495 | 186, 189 | 11884 | 223 |
| 00071 | 332 | 00540 | 155 | 00870 | 112 | 03020 | 341 | 10319 | 386 | 10867 | 231, 232 | 11496 | 189 | 11885 | 223 |
| 00073 | 387 | 00541 | 155 | 00871 | 112 | 03021 | 342 | 10320 | 386 | 10870 | 166, 236 | 11497 | 189 | 11887 | 224 |
| 00074 | 333 | 00542 | 155 | 00872 | 112 | 03023 | 341 | 10321 | 386 | 10871 | 166, 236 | 11498 | 189 | 11888 | 223 |
| 00075 | 140 | 00543 | 155 | 00873 | 112 | 03025 | 341 | 10322 | 388 | 10872 | 166, 236 | 11499 | 189 | 11889 | 224 |
| 00076 | 334 | 00547 | 154 | 00874 | 112 | 03026 | 340 | 10323 | 388 | 10873 | 166, 236 | 11503 | 214 | 11891 | 224 |
| 00077 | 334 | 00548 | 154 | 00875 | 112 | 03027 | 340 | 10325 | 388 | 10887 | 165, 461 | 11505 | 214 | 11892 | 192 |
| 00078 | 331 | 00549 | 154 | 00876 | 112 | 03028 | 341 | 10326 | 388 | 10889 | 461 | 11510 | 212 | 11893 | 192 |
| 00079 | 331 | 00550 | 156 | 00877 | 112 | 03033 | 340 | 10327 | 388 | 10890 | 165, 461 | 11512 | 213 | 11894 | 420 |
| 00081 | 140 | 00551 | 156 | 00888 | 280 | 03610 | 334 | 10328 | 385 | 10907 | 234 | 11514 | 212 | 11901 | 259 |
| 00082 | 140 | 00572 | 329 | 00889 | 280 | 03611 | 334 | 10329 | 385 | 11000 | 132 | 11516 | 213 | 11902 | 259 |
| 00084 | 140 | 00573 | 329 | 00901 | 214 | 03614 | 178 | 10330 | 385 | 11001 | 134, 220, 460 | 11522 | 187 | 11910 | 260 |
| 00085 | 140 | 00574 | 327 | 00929 | 122 | 03615 | 178 | 10331 | 385 | 11003 | 134, 460 | 11523 | 186, 187 | 11911 | 260 |
| 00087 | 140 | 00575 | 328 | 00930 | 122 | 03616 | 178 | 10332 | 385 | 11008 | 113, 205, | 11524 | 186 | 11912 | 260 |
| 00088 | 140 | 00576 | 326 | 00931 | 122 | 03617 | 178 | 10334 | 385 | | 210, 214, | 11526 | 186 | 11913 | 260 |
| 00089 | 140 | 00579 | 327 | 00932 | 122 | 03618 | 178 | 10335 | 385 | | 220, 358, 458 | 11527 | 186 | 11914 | 260 |
| 00090 | 326 | 00580 | 328 | 00941 | 120 | 03619 | 178 | 10336 | 385 | 11010 | 113, 205, | 11528 | 187 | 11915 | 260 |
| 00091 | 326 | 00581 | 398 | 00942 | 120 | 03620 | 178 | 10338 | 388 | | 210, 212, | 11529 | 187 | 11916 | 260 |
| 00092 | 406 | 00600 | 437 | 00945 | 120 | 03621 | 178 | 10339 | 388 | | 214, 220, | 11533 | 215 | 11917 | 260 |
| 00093 | 406 | 00601 | 438 | 00950 | 222 | 03622 | 110, 177 | 10342 | 388 | | 358, 458 | 11538 | 215 | 11920 | 263 |
| 00094 | 406 | 00602 | 438 | 00951 | 222 | 03623 | 110, 177 | 10608 | 237 | 11013 | 458 | 11540 | 210 | 11921 | 280 |
| 00095 | 406 | 00603 | 437 | 00952 | 222 | 03814 | 140 | 10661 | 217, 462 | 11015 | 220 | 11541 | 210 | 11922 | 280 |
| 00096 | 406 | 00604 | 437 | 00953 | 221 | 03824 | 140 | 10663 | 235 | 11016 | 113, 191, | 11542 | 211 | 11923 | 280 |
| 00097 | 406 | 00605 | 438 | 00954 | 221 | 04000 | 339 | 10668 | 194 | | 205, 458 | 11543 | 211 | 11925 | 394 |
| 00098 | 406 | 00606 | 438 | 00955 | 222 | 04001 | 338 | 10700 | 229 | 11017 | 220 | 11553 | 220, 359 | 11927 | 279, 394 |
| 00099 | 406 | 00607 | 438 | 00956 | 222 | 04002 | 338 | 10701 | 237 | 11018 | 171 | 11555 | 220, 359 | 11940 | 281 |
| 00100 | 261 | 00610 | 452 | 00957 | 222 | 04003 | 338 | 10703 | 237 | 11019 | 220 | 11556 | 222 | 11941 | 281 |
| 00105 | 407 | 00611 | 452 | 00959 | 221 | 04004 | 338 | 10704 | 237 | 11020 | 133 | 11562 | 223 | 11942 | 281 |
| 00106 | 407 | 00612 | 452 | 00961 | 122 | 04005 | 338 | 10707 | 237 | 11021 | 358, 460 | 11563 | 390 | 11943 | 281 |
| 00107 | 407 | 00615 | 298 | 00962 | 122 | 04006 | 338 | 10708 | 237 | 11022 | 358, 460 | 11572 | 223 | 11945 | 285 |
| 00108 | 407 | 00616 | 298 | 00963 | 122 | 04007 | 337 | 10709 | 237 | 11023 | 135 | 11573 | 223 | 11946 | 285 |
| 00110 | 406 | 00617 | 298 | 00964 | 122 | 04008 | 337 | 10710 | 237 | 11024 | 135 | 11574 | 390 | 11947 | 285 |
| 00111 | 324 | 00618 | 298 | 00966 | 119 | 04012 | 339 | 10711 | 237 | 11025 | 135 | 11575 | 390 | 11950 | 281 |
| 00113 | 406 | 00619 | 298 | 00969 | 119 | 04013 | 339 | 10712 | 237 | 11026 | 358, 359, 460 | 11576 | 390 | 11955 | 279 |
| 00114 | 406 | 00620 | 298 | 00971 | 121, 127, 381 | 04015 | 336 | 10713 | 237 | 11027 | 353, 358, 359 | 11577 | 391 | 11957 | 279 |
| 00116 | 406 | 00621 | | | | | | | | | | | | | |

| | | | | | | | | | | | | | | | |
|-------|------------------------------|-------|----------|-------|---|-------|---------------|-------|----------|-------|---------------|-------|----------|-------|-----|
| 11999 | 278 | 13930 | 172 | 15218 | 20 | 30046 | 405 | 33238 | 183 | 40009 | 280, 355 | 40311 | 372, 375 | 50305 | 346 |
| 12000 | 132 | 13931 | 172 | 15219 | 20 | 30047 | 405 | 33240 | 180 | 40100 | 152 | 40312 | 372, 375 | 50310 | 346 |
| 12008 | 458 | 13935 | 172 | 15220 | 20 | 30048 | 405 | 33241 | 80 | 40101 | 152 | 40313 | 372, 375 | 50315 | 346 |
| 12010 | 458 | 13936 | 172 | 15221 | 31 | 30049 | 405 | 33242 | 80 | 40102 | 152 | 40320 | 375 | 50400 | 346 |
| 12040 | 133 | 13940 | 170 | 15222 | 31 | 30050 | 165 | 33243 | 87 | 40103 | 152 | 40330 | 376 | 50500 | 347 |
| 12065 | 133 | 13941 | 170 | 15223 | 31 | 30052 | 165 | 33244 | 93, 219 | 40104 | 152 | 40331 | 376 | 50501 | 347 |
| 12100 | 132 | 13942 | 170 | 15224 | 31 | 30054 | 385, 405 | 33245 | 93, 219 | 40105 | 152 | 40400 | 324 | 50510 | 346 |
| 12221 | 257 | 13950 | 171 | 15225 | 31 | 30055 | 385, 405 | 33246 | 125, 219 | 40110 | 363 | 40401 | 324 | 50600 | 348 |
| 12222 | 258 | 13951 | 171 | 15226 | 31 | 30056 | 385, 405 | 33247 | 125, 219 | 40115 | 363 | 40405 | 370 | 50601 | 348 |
| 12225 | 258 | 13952 | 171 | 15227 | 31 | 30057 | 405 | 33248 | 183 | 40125 | 357 | 40415 | 373 | 50602 | 348 |
| 12228 | 258 | 13955 | 170 | 15228 | 31 | 30100 | 145 | 33250 | 177 | 40126 | 353 | 40420 | 371 | 50605 | 348 |
| 12232 | 257 | 13960 | 170 | 15230 | 20 | 30101 | 145 | 33251 | 177 | 40127 | 357 | 40421 | 371 | 50606 | 348 |
| 12233 | 254 | 13965 | 193 | 15231 | 20 | 30102 | 145 | 33252 | 177 | 40128 | 353 | 40422 | 371 | 50607 | 348 |
| 12235 | 258 | 13966 | 175 | 15232 | 20 | 30103 | 145 | 33260 | 176 | 40129 | 353 | 40423 | 371 | 50610 | 348 |
| 12236 | 254 | 13980 | 165 | 15233 | 20 | 30104 | 145 | 33261 | 176 | 40130 | 280, 355 | 40424 | 376 | 50611 | 348 |
| 12240 | 254 | 13981 | 165 | 15234 | 20 | 30105 | 145 | 33262 | 176 | 40131 | 280, 355 | 40425 | 332 | 50612 | 348 |
| 12243 | 259 | 13985 | 167 | 15235 | 20 | 30107 | 153 | 33265 | 179 | 40132 | 352 | 40430 | 372 | 50700 | 349 |
| 12244 | 259 | 13987 | 166, 195 | 15236 | 30 | 30108 | 153 | 33266 | 179 | 40135 | 352 | 40431 | 372 | 50701 | 349 |
| 12245 | 254 | 13990 | 164 | 15250 | 31 | 30109 | 153 | 33267 | 179 | 40137 | 352 | 40432 | 372 | 50702 | 349 |
| 12249 | 254 | 13995 | 167 | 15251 | 31 | 30110 | 153 | 34247 | 94, 183 | 40139 | 352 | 40433 | 372 | 50705 | 349 |
| 12260 | 254 | 14910 | 173 | 15252 | 31 | 30111 | 159 | 34248 | 94, 183 | 40140 | 352 | 40440 | 375 | 50706 | 349 |
| 12285 | 262 | 14911 | 173 | 15253 | 31 | 30112 | 159 | 35050 | 266 | 40144 | 178, 352 | 40441 | 372, 375 | 50707 | 349 |
| 12287 | 251, 262 | 14915 | 173 | 15255 | 27 | 30113 | 159 | 35065 | 266 | 40146 | 352 | 40443 | 377 | 50710 | 349 |
| 12289 | 249, 262 | 14916 | 173 | 15256 | 27 | 30114 | 159 | 35070 | 266 | 40148 | 358, 220, 352 | 40444 | 377 | 50711 | 349 |
| 12290 | 262 | 14920 | 173 | 15257 | 27 | 30115 | 159 | 35343 | 266 | 40149 | 353 | 40450 | 375 | 50712 | 349 |
| 12291 | 247, 248, 263 | 14921 | 173 | 15258 | 27 | 30116 | 159 | 35711 | 152 | 40150 | 358 | 40453 | 376 | 50800 | 348 |
| 12292 | 250, 262 | 14925 | 173 | 15259 | 27 | 30117 | 159 | 35712 | 152 | 40152 | 352 | 40454 | 376 | 50801 | 348 |
| 12294 | 262 | 14926 | 173 | 15261 | 27 | 30118 | 159 | 35720 | 123 | 40153 | 353 | 40455 | 373 | 50802 | 348 |
| 12295 | 244, 245, 246, 247, 248, 263 | 14930 | 172 | 15262 | 27 | 30119 | 158 | 35730 | 123 | 40154 | 219, 220, 359 | 40457 | 373 | 50805 | 348 |
| 12296 | 246, 263 | 14931 | 172 | 15263 | 27 | 30120 | 86 | 35734 | 123 | 40159 | 219, 352, 359 | 40458 | 373 | 50806 | 348 |
| 12299 | 263 | 14935 | 172 | 15270 | 23 | 30121 | 86 | 35735 | 123 | 40160 | 352 | 40460 | 373 | 50807 | 348 |
| 12300 | 255 | 14936 | 172 | 15271 | 23 | 30122 | 86 | 35912 | 152 | 40161 | 219, 352, 359 | 40461 | 373, 374 | 50810 | 349 |
| 12310 | 258 | 14940 | 170 | 15272 | 23 | 30123 | 159 | 35930 | 123 | 40179 | 355 | 40462 | 373, 374 | 50811 | 349 |
| 12340 | 256 | 14941 | 170 | 15300 | 29 | 30124 | 159 | 36002 | 309 | 40182 | 355 | 40463 | 373 | 50812 | 349 |
| 12350 | 250 | 14942 | 170 | 15301 | 29 | 30126 | 158, 388 | 36007 | 309 | 40191 | 352 | 40464 | 373 | 50815 | 348 |
| 12355 | 256 | 14950 | 171 | 15302 | 29 | 30127 | 158, 388 | 36009 | 309 | 40192 | 352 | 40470 | 374 | 50816 | 348 |
| 12356 | 257 | 14951 | 171 | 15303 | 29 | 30136 | 158, 388 | 36010 | 306 | 40193 | 352 | 40472 | 374 | 50817 | 348 |
| 12357 | 257 | 14952 | 171 | 15310 | 29 | 30137 | 158, 388 | 36011 | 309 | 40194 | 352 | 40474 | 374 | 50820 | 348 |
| 12358 | 250 | 14953 | 174 | 15311 | 29 | 30200 | 362 | 36012 | 308 | 40195 | 352 | 40476 | 374 | 50821 | 348 |
| 12360 | 256 | 14954 | 174 | 15312 | 29 | 30201 | 363 | 36013 | 304 | 40196 | 352 | 40478 | 374 | 50822 | 348 |
| 12361 | 249 | 14956 | 174 | 15313 | 29 | 30202 | 363 | 36014 | 315 | 40198 | 354 | 40480 | 374 | 50900 | 347 |
| 12362 | 250 | 14965 | 193 | 15320 | 33 | 30203 | 360 | 36015 | 304 | 40199 | 354 | 40482 | 376 | 50905 | 347 |
| 12365 | 249 | 14966 | 175 | 15321 | 33 | 30204 | 360 | 36017 | 306 | 40200 | 149 | 40485 | 377 | 50910 | 347 |
| 12366 | 245, 248 | 14970 | 174 | 15322 | 33 | 30210 | 362 | 36019 | 315 | 40201 | 149 | 40486 | 379 | 50915 | 347 |
| 12368 | 250 | 14980 | 165 | 15323 | 33 | 30220 | 362 | 36020 | 292 | 40202 | 149 | 40487 | 379 | | |
| 12370 | 244 | 14981 | 165 | 15324 | 33 | 30230 | 362 | 36021 | 292 | 40203 | 149 | 40488 | 379 | | |
| 12371 | 245 | 14985 | 167 | 15325 | 33 | 30240 | 362 | 36022 | 304 | 40204 | 149 | 40490 | 378 | | |
| 12372 | 245 | 14987 | 166, 195 | 15326 | 33 | 30250 | 362 | 36024 | 304 | 40205 | 149 | 40498 | 378 | | |
| 12373 | 244 | 14990 | 164 | 15331 | 33 | 30260 | 408 | 36025 | 292 | 40206 | 149 | 40499 | 378 | | |
| 12374 | 245 | 14995 | 167 | 15332 | 33 | 30261 | 408 | 36026 | 291 | 40207 | 149 | 40500 | 384 | | |
| 12375 | 245 | 15100 | 19 | 15333 | 33 | 30263 | 408 | 36027 | 304 | 40210 | 361 | 40501 | 384 | | |
| 12376 | 245 | 15101 | 19 | 15335 | 33 | 30264 | 408 | 36028 | 291 | 40211 | 361 | 40502 | 384 | | |
| 12378 | 248 | 15102 | 19 | 15340 | 21 | 30266 | 408 | 36029 | 304 | 40212 | 361 | 40503 | 384 | | |
| 12385 | 245 | 15103 | 19 | 15341 | 21 | 30267 | 408 | 36030 | 300 | 40213 | 361 | 40504 | 384 | | |
| 12386 | 246 | 15104 | 19 | 15342 | 21 | 30270 | 362 | 36032 | 302 | 40214 | 361 | 40505 | 384 | | |
| 12390 | 248 | 15105 | 19 | 15343 | 21 | 30272 | 362 | 36033 | 303 | 40215 | 361 | 40506 | 379 | | |
| 12391 | 246 | 15106 | 19 | 15344 | 21 | 30276 | 363 | 36034 | 302 | 40216 | 361 | 40520 | 381 | | |
| 12393 | 248 | 15107 | 19 | 15345 | 21 | 30277 | 363 | 36036 | 301 | 40220 | 351 | 40521 | 381 | | |
| 12394 | 246 | 15108 | 19 | 15346 | 21 | 30279 | 356 | 36037 | 303 | 40222 | 219, 351, 359 | 40522 | 381 | | |
| 12395 | 249 | 15110 | 19 | 15347 | 21 | 30280 | 356 | 36038 | 300 | 40223 | 350 | 40524 | 381 | | |
| 12396 | 247 | 15111 | 19 | 15348 | 21 | 30281 | 356 | 36042 | 301 | 40224 | 351 | 40530 | 381 | | |
| 12397 | 245, 247 | 15112 | 19 | 15350 | 25, 43, 456 | 30282 | 356 | 36044 | 296 | 40225 | 350 | 40531 | 381 | | |
| 12398 | 247 | 15113 | 19 | 15351 | 23, 25, 43, 456 | 30283 | 356 | 36045 | 296 | 40226 | 351 | 40532 | 381 | | |
| 12399 | 247 | 15114 | 19 | | | 30284 | 356 | 36046 | 296 | 40227 | 350 | 40534 | 381 | | |
| 12403 | 248 | 15115 | 19 | 15921 | 150 | 30285 | 356 | 36047 | 295 | 40228 | 351 | 40540 | 381 | | |
| 12404 | 246 | 15116 | 19 | 15925 | 150 | 30286 | 219, 356, 359 | 36048 | 295 | 40229 | 350 | 40541 | 381 | | |
| 12415 | 175 | 15117 | 19 | 15926 | 150 | 30287 | 356 | 36049 | 297 | 40230 | 351 | 40542 | 381 | | |
| 12428 | 240 | 15120 | 30 | 16905 | 117, 161 | 30288 | 219, 356, 359 | 36050 | 301 | 40234 | 361 | 40543 | 382 | | |
| 12429 | 240 | 15125 | 31 | 17910 | 170 | 30299 | 151, 357 | 36052 | 295 | 40235 | 361 | 40544 | 382 | | |
| 12430 | 241 | 15126 | 31 | 17920 | 172 | 30310 | 363 | 36053 | 295 | 40236 | 361 | 40545 | 382 | | |
| 12431 | 241 | 15127 | 31 | 17921 | 172 | 30320 | 363 | 36054 | 295 | 40237 | 361 | 40600 | 114 | | |
| 12432 | 241 | 15128 | 31 | 17922 | 171 | 30325 | 184 | 36055 | 297 | 40240 | 178, 351 | 40601 | 114 | | |
| 12435 | 241 | 15130 | 25 | 18380 | 113, 205, 457 | 30330 | 324 | 36056 | 297 | 40242 | 219, 351, 359 | 40605 | 116 | | |
| 12436 | 241 | 15131 | 25 | 18381 | 457 | 30332 | 293 | 36057 | 297 | 40243 | 350 | 40606 | 116 | | |
| 12440 | 239 | 15132 | 25 | 18383 | 457 | 30333 | 324 | 36062 | 299 | 40244 | 351 | 40607 | 116 | | |
| 12441 | 239 | 15133 | 25 | 18387 | 211, 353, 457 | 30340 | 360 | 36063 | 299 | 40245 | 350 | 40610 | 114 | | |
| 12442 | 239 | 15135 | 23 | 18388 | 25, 29, 100, 136, 204, 207, 211, 213, 215, 353, 457 | 30341 | 360 | 36064 | 302 | 40246 | 351 | 40611 | 114 | | |
| 12879 | 109, 329, 330, 462 | 15136 | 23 | | | 30350 | 360 | 36065 | 296 | 40247 | 350 | 40620 | 114 | | |
| | | 15137 | 23 | | | 30351 | 360 | 36066 | 292 | 40248 | 351 | 40621 | 114 | | |
| | | 15140 | 22 | | | 30360 | 360 | 36068 | 293 | 40249 | 350 | 40630 | 115 | | |
| 12910 | 173 | 15141 | 22 | | | 30361 | 360 | 36069 | 293 | 40250 | 351 | 40631 | 115 | | |
| 12911 | 173 | 15142 | 22 | | | 30370 | 360 | 36071 | 295 | 40260 | 351 | 40640 | 115 | | |
| 12915 | 173 | 15150 | 27 | | | 30371 | 360 | 36072 | 295 | 40262 | 219, 351, 359 | 40641 | 115 | | |
| 12916 | 173 | 15151 | 27 | | | 30380 | 360 | 36073 | 295 | 40263 | 351 | 40650 | 115 | | |
| 12920 | 173 | 15152 | 27 | | | | | | | | | | | | |

| | | | | | | | | | | | | | | | |
|----------|----------|-------|----------|----------|----------|-------|----------|-------|----------|-------|-------------------|-------|--------------|-------|--------------|
| 60536 | 365 | 73511 | 401 | 8 | 82028 | 274 | 83424 | 105 | 83651 | 66 | 83820 | 71 | 83958 | 45 | |
| 60537 | 365 | 73512 | 401 | 80021 | 272 | 82029 | 274 | 83426 | 105 | 83652 | 66 | 83822 | 71 | 83960 | 77 |
| 60538 | 364 | 73513 | 401 | 80022 | 272 | 82030 | 274 | 83433 | 82 | 83654 | 66 | 83824 | 71 | 83961 | 77 |
| 60539 | 364 | 73700 | 400 | 80023 | 271 | 82032 | 274 | 83434 | 82 | 83655 | 66 | 83826 | 71 | 83962 | 77 |
| 60540 | 367 | 73701 | 400 | 80024 | 271 | 82034 | 274 | 83435 | 91 | 83657 | 66 | 83828 | 70, 97 | 83963 | 77 |
| 60541 | 367 | 73702 | 400 | 80025 | 271 | 82036 | 274 | 83436 | 91 | 83658 | 66 | 83830 | 70 | 83964 | 77 |
| 60542 | 367 | 73703 | 400 | 80026 | 271 | 82037 | 274 | 83437 | 91 | 83660 | 66 | 83832 | 70 | 83965 | 77 |
| 60550 | 370, 389 | 73710 | 400 | 80027 | 271 | 82038 | 274 | 83438 | 91 | 83661 | 66 | 83834 | 70 | 83966 | 77 |
| 60551 | 370, 389 | 73711 | 400 | 81000 | 269 | 82040 | 274 | 83439 | 91 | 83663 | 66 | 83836 | 70 | 83967 | 77 |
| 60552 | 370, 389 | 73712 | 400 | 81095 | 269 | 82042 | 274 | 83440 | 91 | 83664 | 66 | 83838 | 70 | 83968 | 103 |
| 60553 | 370, 389 | 73713 | 400 | 81100 | 269 | 82050 | 274 | 83441 | 91 | 83696 | 92 | 83840 | 70 | 83969 | 103 |
| 60554 | 370, 389 | 73714 | 400 | 81101 | 269 | 82051 | 274 | 83442 | 91 | 83697 | 92 | 83842 | 105 | 83971 | 45 |
| 61150 | 143 | 73719 | 400 | 81102 | 269 | 82059 | 274 | 83443 | 91 | 83698 | 92 | 83843 | 105 | 83980 | 45, 282 |
| 61155 | 143 | 73725 | 400 | 81104 | 269 | 82100 | 276 | 83444 | 91 | 83699 | 92 | 83844 | 105 | 83981 | 45 |
| 61190 | 143 | 73726 | 400 | 81106 | 269 | 82101 | 275 | 83445 | 91 | 83700 | 92, 165, 192, 201 | 83845 | 105 | 83991 | 94, 110 |
| 61195 | 143 | 73727 | 400 | 81108 | 269 | 82104 | 275 | 83446 | 91 | | | 83847 | 396 | 83992 | 44 |
| 61280 | 143 | 73739 | 401 | 81109 | 269 | 82106 | 275 | 83447 | 91 | 83701 | 92, 165, 192, 201 | 83848 | 102, 151 | 83993 | 94, 110 |
| 61285 | 143 | 73740 | 401 | 81116 | 255, 264 | 82108 | 275 | 83448 | 91 | | | 83850 | 105 | 83994 | 44 |
| 61400 | 143 | 73741 | 401 | 81191 | 270 | 82110 | 275 | 83449 | 91 | 83702 | 92, 165, 192 | 83851 | 102, 151 | 83995 | 94, 110 |
| 64001 | 265 | 73742 | 401 | 81195 | 270 | 82112 | 275 | 83450 | 84 | 83703 | 92, 165, 192 | 83862 | 91 | 83996 | 95, 144 |
| 64051 | 265 | 73743 | 401 | 81198 | 273 | 82113 | 275 | 83451 | 84 | 83704 | 92 | 83863 | 91 | 83997 | 94, 110 |
| 64151 | 265 | 73744 | 401 | 81199 | 273 | 82114 | 275 | 83452 | 84 | 83705 | 92 | 83864 | 91 | 83998 | 394 |
| 64201 | 265 | 73750 | 400, 416 | 81200 | 269 | 82116 | 275 | 83453 | 84 | 83710 | 54 | 83865 | 91 | 83999 | 394 |
| 65010 | 265 | 73800 | 441 | 81201 | 269 | 82117 | 275 | 83454 | 84 | 83712 | 54 | 83866 | 91 | 84000 | 89 |
| 65020 | 265 | 74201 | 444 | 81202 | 269 | 82118 | 275 | 83455 | 84 | 83714 | 55 | 83867 | 106 | 84001 | 89 |
| 65030 | 265 | 74207 | 145 | 81204 | 269 | 82119 | 275 | 83456 | 84 | 83716 | 55 | 83868 | 106 | 84002 | 89 |
| 65033 | 265 | 74400 | 402 | 81206 | 269 | 82120 | 275 | 83457 | 84 | 83718 | 56 | 83869 | 83, 100, 207 | 84003 | 89 |
| 65034 | 265 | 74401 | 402 | 81208 | 269 | 82122 | 275 | 83466 | 84 | 83720 | 56 | 83871 | 91 | 84004 | 89 |
| 65035 | 265 | 74402 | 402 | 81209 | 269 | 82123 | 275 | 83467 | 84 | 83721 | 56 | 83872 | 91 | 84005 | 89 |
| 65065 | 264 | 74403 | 402 | 81292 | 270 | 82128 | 275 | 83468 | 84 | 83722 | 57 | 83873 | 91 | 84006 | 89 |
| 65066 | 264 | 74404 | 402 | 81295 | 270 | 82129 | 275 | 83469 | 84 | 83723 | 56 | 83874 | 91 | 84007 | 89 |
| | | 74698 | 403 | 81296 | 273 | 82130 | 275 | 83479 | 82 | 83724 | 57 | 83875 | 81 | 84017 | 99 |
| 7 | | 74699 | 403 | 81300 | 269 | 82132 | 275 | 83480 | 82 | 83725 | 56 | 83876 | 81 | 84018 | 99 |
| 70303 | 412 | 74700 | 403 | 81302 | 269 | 82134 | 275 | 83481 | 82 | 83726 | 56 | 83877 | 81 | 84020 | 108, 454 |
| 70306 | 412 | 74701 | 403 | 81304 | 269 | 82137 | 275 | 83482 | 82 | 83727 | 56 | 83878 | 97 | 84021 | 108, 454 |
| 71001 | 443 | 74702 | 403 | 81306 | 269 | 82138 | 275 | 83483 | 83 | 83728 | 56 | 83879 | 97 | 84022 | 59 |
| 71002 | 443 | 74703 | 403 | 81308 | 269 | 82140 | 275 | 83484 | 83 | 83729 | 55 | 83880 | 92, 201 | 84023 | 59 |
| 71003 | 443 | 74704 | 403 | 81391 | 270 | 82142 | 275 | 83486 | 105 | 83730 | 56 | 83881 | 92, 201 | 84024 | 59 |
| 71004 | 443 | 74705 | 403 | 81395 | 270 | 82150 | 275 | 83487 | 105 | 83731 | 55 | 83882 | 82 | 84025 | 59 |
| 71005 | 443 | 74706 | 403 | 81400 | 269 | 82151 | 275 | 83488 | 325 | 83732 | 56 | 83884 | 83 | 84026 | 59 |
| 71006 | 443 | 74721 | 403 | 81401 | 269 | 82159 | 275 | 83489 | 325 | 83733 | 55 | 83886 | 83 | 84028 | 98 |
| 71008 | 443 | 74722 | 403 | 81402 | 269 | 82200 | 276 | 83490 | 82 | 83734 | 58 | 83887 | 105 | 84029 | 98 |
| 71009 | 452 | 74730 | 404 | 81404 | 269 | 82210 | 248 | 83491 | 82 | 83735 | 55 | 83888 | 105 | 84035 | 106 |
| 71010 | 452 | 74731 | 404 | 81406 | 269 | 82215 | 248 | 83492 | 82 | 83736 | 58 | 83889 | 105 | 84036 | 106 |
| 71011 | 452 | 74732 | 404 | 81408 | 269 | 82300 | 276 | 83493 | 83 | 83737 | 55 | 83890 | 101, 419 | 84037 | 95 |
| 71012 | 452 | 74733 | 404 | 81492 | 270 | 82307 | 124 | 83494 | 83 | 83738 | 58 | 83891 | 101, 419 | 84038 | 95 |
| 71013 | 452 | 74750 | 391, 444 | 81495 | 270 | 82308 | 124 | 83497 | 86 | 83739 | 55 | 83892 | 101, 419 | 84039 | 381 |
| 71014 | 452 | 74751 | 391, 444 | 81502 | 269 | 82309 | 124 | 83498 | 86 | 83740 | 58 | 83893 | 101, 419 | 84040 | 68 |
| 71015 | 452 | 75001 | 443 | 81504 | 269 | 82310 | 125 | 83499 | 86 | 83742 | 58 | 83894 | 91 | 84041 | 68 |
| 71400 | 318 | 75002 | 443 | 81506 | 269 | 82312 | 125 | 83500 | 102 | 83744 | 58 | 83895 | 91 | 84042 | 68 |
| 71401 | 335 | 75600 | 444 | 81591 | 270 | 82314 | 125 | 83513 | 102 | 83748 | 75, 276 | 83896 | 91 | 84043 | 68 |
| 71402 | 335 | 75800 | 450 | 81595 | 270 | 82316 | 125 | 83514 | 102 | 83749 | 75, 276 | 83897 | 98, 255 | 84045 | 154 |
| 71403 | 335 | 75801 | 450 | 81602 | 269 | 82318 | 127 | 83517 | 83 | 83750 | 75, 276 | 83900 | 79 | 84046 | 85, 101, 174 |
| 71404 | 335 | 75802 | 448 | 81604 | 269 | 82319 | 127 | 83536 | 391, 397 | 83751 | 75, 276 | 83901 | 79 | 84047 | 85, 101, 174 |
| 71405 | 335 | 75803 | 449 | 81606 | 269 | 82328 | 126, 193 | 83537 | 397 | 83752 | 75, 276 | 83902 | 79 | 84048 | 85, 101, 174 |
| 71406 | 335 | 75804 | 449 | 81608 | 269 | 82338 | 126 | 83538 | 397 | 83753 | 75, 276 | 83903 | 79 | 84050 | 73 |
| 71407 | 335 | 75805 | 310, 449 | 81692 | 270 | 82345 | 125 | 83560 | 85 | 83754 | 75, 276 | 83904 | 79 | 84051 | 73 |
| 71408 | 335 | 75806 | 450 | 81695 | 270 | 82346 | 126 | 83561 | 85 | 83755 | 75, 276 | 83905 | 79 | 84052 | 73 |
| 71409 | 335 | 75807 | 450 | 81700 | 269 | 82347 | 126 | 83562 | 85 | 83756 | 75, 276 | 83906 | 79 | 84053 | 73 |
| 71410 | 335 | 75808 | 451 | 81701 | 269 | 82370 | 127 | 83563 | 85 | 83757 | 75, 276 | 83907 | 79 | 84054 | 72 |
| 71411 | 335 | 75809 | 451 | 81702 | 269 | 82371 | 127 | 83564 | 85 | 83758 | 75, 276 | 83908 | 79 | 84055 | 73 |
| 71412 | 335 | 75810 | 451 | 81704 | 269 | 82394 | 127 | 83565 | 85 | 83759 | 75, 276 | 83909 | 79 | 84056 | 73 |
| 71413 | 335 | 75817 | 449 | 81706 | 269 | 82395 | 127 | 83566 | 85 | 83760 | 74, 277 | 83910 | 79 | 84057 | 73 |
| 71414 | 335 | 75900 | 448 | 81707 | 269 | 82419 | 281 | 83567 | 85 | 83761 | 74, 277 | 83911 | 79 | 84058 | 72 |
| 71415 | 335 | 75901 | 447 | 81791 | 270 | 82420 | 281 | 83568 | 84 | 83762 | 74, 277 | 83912 | 79, 97 | 84059 | 73 |
| 71416 | 335 | 75902 | 447 | 81795 | 270 | 82502 | 271 | 83569 | 84 | 83763 | 74, 277 | 83913 | 79, 97 | 84060 | 73 |
| 71418 | 335 | 75903 | 446 | 81796 | 273 | 82504 | 271 | 83570 | 84 | 83764 | 74, 277 | 83914 | 79 | 84061 | 72 |
| 71419 | 335 | 75904 | 446 | 81800 | 269 | 82506 | 271 | 83571 | 84 | 83765 | 74, 277 | 83915 | 79 | 84062 | 73 |
| 71421 | 335 | 75905 | 446 | 81801 | 269 | 82508 | 271 | 83572 | 84 | 83766 | 74, 277 | 83916 | 79 | 84063 | 73 |
| 71430 | 391, 451 | 75906 | 448 | 81802 | 269 | 82510 | 271 | 83573 | 84 | 83768 | 74, 277 | 83917 | 79 | 84064 | 73 |
| 71431 | 314 | 75907 | 447 | 81804 | 269 | 82512 | 271 | 83574 | 84 | 83769 | 74, 277 | 83918 | 79 | 84065 | 72 |
| 71433 | 318 | 75908 | 447 | 81806 | 269 | 82514 | 271 | 83575 | 84 | 83770 | 74, 277 | 83919 | 79 | 84066 | 73 |
| 71440 | 284 | 75909 | 448 | 81891 | 270 | 82516 | 271 | 83587 | 98 | 83772 | 74, 277 | 83920 | 79, 160, 216 | 84067 | 73 |
| 71441 | 285 | 75910 | 446 | 81895 | 270 | 82518 | 271 | 83588 | 82 | 83773 | 74, 277 | 83921 | 79 | 84068 | 72 |
| 71450 | 329 | 75911 | 446 | 81901 | 270 | 82520 | 271 | 83589 | 82 | 83777 | 92 | 83922 | 79 | 84069 | 73 |
| 71451 | 329 | 75912 | 448 | 81902 | 270 | 82522 | 271 | 83592 | 82 | 83779 | 67 | 83923 | 79 | 84073 | 73 |
| 71452 | 329 | 77302 | 415 | 81903 | 270 | 82524 | 271 | 83593 | 82 | 83780 | 92 | 83924 | 79 | 84076 | 73 |
| 71453 | 329 | 77303 | 415 | 81904 | 270 | 82526 | 272 | 83594 | 82 | 83781 | 92 | 83925 | 79 | 84080 | 840 |
| 71454 | 329 | 77304 | 415 | 81905 | 270 | 82528 | 272 | 83597 | 82 | 83782 | 92 | 83926 | 79 | 84081 | 840 |
| 71455 | 329 | 77305 | 415 | 81906 | 270 | 82530 | 272 | 83598 | 82 | 83783 | 92 | 83928 | 54 | 84082 | 840 |
| 71460 | 333 | 77320 | 414 | 81907 | 270 | 82532 | 272 | 83599 | 82 | 83784 | 92 | 83929 | 54 | 84083 | 840 |
| 71461 | 333 | 77321 | 414 | 81908 | 270 | 83301 | 162 | 83600 | 85, 461 | 83785 | 67 | 83932 | 57 | 84084 | 840 |
| 71462 | 333 | 77322 | 414 | 81909 | 270 | 83303 | | | | | | | | | |

| | | | | | | | | | | | | | | | |
|-------|---------|-------|---------|-------|---------|-------|-----|-------|----------|-------|----------|----------|----------|-------|----------|
| 84124 | 62 | 84191 | 40 | 84271 | 47 | 84345 | 55 | 88099 | 151 | 88806 | 323 | 88922 | 431 | 93144 | 316 |
| 84125 | 62 | 84192 | 40 | 84272 | 47 | 84346 | 55 | 88111 | 420 | 88810 | 422 | 88923 | 431 | 93145 | 316 |
| 84126 | 62 | 84193 | 40 | 84273 | 47 | 84347 | 55 | 88122 | 407 | 88811 | 422 | 88924 | 431 | 93146 | 316 |
| 84127 | 62 | 84194 | 40 | 84274 | 47 | 84348 | 55 | 88123 | 407 | 88812 | 422 | 88925 | 431 | 93147 | 316 |
| 84128 | 61, 841 | 84195 | 41 | 84275 | 47 | 84349 | 55 | 88133 | 407 | 88813 | 422 | 88926 | 431 | 93148 | 316 |
| 84129 | 61 | 84196 | 41 | 84276 | 47 | 84350 | 55 | 88134 | 407 | 88814 | 423 | 88927 | 431 | 93149 | 316 |
| 84130 | 61 | 84197 | 41 | 84277 | 47 | 84351 | 55 | 88144 | 272 | 88815 | 423 | 88928 | 432 | 93150 | 408 |
| 84131 | 61 | 84198 | 41 | 84280 | 47 | 84352 | 55 | 88244 | 272 | 88816 | 423 | 88929 | 432 | 93151 | 408 |
| 84132 | 61 | 84199 | 41 | 84281 | 47 | 84353 | 55 | 88245 | 272 | 88817 | 423 | 88930 | 435 | 93152 | 311 |
| 84133 | 61 | 84200 | 95 | 84282 | 47 | 84354 | 55 | 88246 | 272 | 88818 | 423 | 88931 | 432 | 93153 | 311 |
| 84134 | 61 | 84201 | 95 | 84283 | 47 | 84355 | 55 | 88247 | 272 | 88819 | 423 | 88932 | 432 | 93154 | 410 |
| 84135 | 61 | 84202 | 95 | 84284 | 47 | 84405 | 182 | 88248 | 272 | 88820 | 423 | 88933 | 432 | 93155 | 410 |
| 84136 | 61 | 84203 | 95 | 84285 | 47 | 84406 | 182 | 88249 | 272 | 88821 | 423 | 88934 | 432 | 93156 | 410 |
| 84137 | 62 | 84205 | 37 | 84286 | 47 | 84407 | 182 | 88250 | 272 | 88822 | 423 | 88935 | 433 | 93157 | 410 |
| 84140 | 841 | 84206 | 37 | 84287 | 47 | 84408 | 84 | 88255 | 401 | 88823 | 424 | 88936 | 433 | 93160 | 321 |
| 84141 | 841 | 84207 | 37 | 84290 | 48 | 84409 | 84 | 88256 | 401 | 88824 | 424 | 88937 | 433 | 93161 | 322 |
| 84142 | 841 | 84208 | 37 | 84291 | 48 | 84410 | 84 | 88271 | 408 | 88825 | 424 | 88938 | 433 | 93162 | 322 |
| 84143 | 841 | 84209 | 37 | 84292 | 48 | 84414 | 84 | 88285 | 273, 416 | 88826 | 424 | 88939 | 433 | 93163 | 410 |
| 84144 | 49 | 84210 | 96 | 84293 | 48 | 84415 | 84 | 88287 | 420 | 88827 | 424 | 88940 | 433 | 93170 | 322 |
| 84145 | 49 | 84211 | 96 | 84295 | 48 | 84416 | 84 | 88288 | 420 | 88828 | 425 | 88941 | 433 | 93172 | 313 |
| 84146 | 49 | 84212 | 325 | 84296 | 48 | 84417 | 84 | 88598 | 107, 453 | 88829 | 425 | 88942 | 433 | 93174 | 306 |
| 84147 | 49 | 84213 | 325 | 84297 | 48 | 84418 | 84 | 88601 | 442 | 88830 | 425 | 88943 | 433 | 93175 | 305 |
| 84148 | 49 | 84215 | 96 | 84298 | 48 | 84420 | 84 | 88607 | 404 | 88831 | 425 | 88944 | 434 | 93180 | 307 |
| 84149 | 49 | 84216 | 96 | 84300 | 75, 276 | 84421 | 84 | 88608 | 438 | 88832 | 426 | 88945 | 434 | 93181 | 307 |
| 84150 | 73 | 84217 | 42, 60 | 84301 | 75, 276 | 84422 | 84 | 88609 | 106, 453 | 88833 | 426 | 88946 | 434 | 93182 | 307 |
| 84151 | 73 | 84218 | 42, 60 | 84302 | 75, 276 | 84423 | 84 | 88615 | 402 | 88834 | 426 | 88947 | 434 | 93183 | 307 |
| 84152 | 73 | 84220 | 96 | 84303 | 75, 276 | 84429 | 85 | 88616 | 402 | 88835 | 426 | 88948 | 434 | 93189 | 314 |
| 84153 | 73 | 84221 | 96 | 84304 | 75, 276 | 84430 | 85 | 88617 | 403 | 88836 | 427 | 88949 | 434 | 93190 | 310 |
| 84155 | 73 | 84222 | 96 | 84305 | 75, 276 | 84440 | 85 | 88618 | 403 | 88837 | 427 | | | 93191 | 312 |
| 84156 | 73 | 84225 | 226 | 84306 | 75, 276 | 84441 | 85 | 88619 | 403 | 88838 | 427 | 9 | | 93192 | 312, 452 |
| 84157 | 73 | 84226 | 60 | 84307 | 75, 276 | 84442 | 85 | 88621 | 403 | 88839 | 427 | 90901 | 208 | 93195 | 452 |
| 84158 | 60, 841 | 84227 | 60 | 84308 | 75, 276 | 84485 | 67 | 88626 | 107, 453 | 88840 | 427 | 90902 | 208, 209 | 93196 | 452 |
| 84159 | 73 | 84229 | 63 | 84309 | 75, 276 | 84786 | 67 | 88627 | 107, 453 | 88841 | 428 | 93101 | 309 | 93200 | 305 |
| 84160 | 73 | 84230 | 63 | 84310 | 75, 276 | 84787 | 67 | 88628 | 107, 453 | 88842 | 428 | 93102 | 322 | 93202 | 321 |
| 84161 | 49 | 84231 | 63 | 84311 | 75, 276 | 84788 | 67 | 88631 | 435 | 88843 | 428 | 93105 | 227, 302 | 93206 | 321 |
| 84162 | 73 | 84232 | 63 | 84312 | 42 | 84789 | 67 | 88633 | 404 | 88844 | 428 | 93108 | 320 | 93207 | 321 |
| 84163 | 73 | 84233 | 63 | 84314 | 42 | 84790 | 67 | 88636 | 106, 453 | 88845 | 429 | 93109 | 320 | 93220 | 305 |
| 84164 | 73 | 84234 | 63 | 84315 | 42 | 84970 | 69 | 88637 | 438 | 88846 | 307, 429 | 93110 | 319 | 93222 | 410 |
| 84165 | 49 | 84235 | 97 | 84317 | 42 | 84971 | 69 | 88640 | 437 | 88847 | 429 | 93111 | 319 | 93223 | 410 |
| 84166 | 73 | 84236 | 97 | 84320 | 50 | 84972 | 69 | 88642 | 437 | 88848 | 429 | 93112 | 310 | 93224 | 410 |
| 84167 | 73 | 84237 | 97 | 84321 | 50 | 84973 | 69 | 88643 | 449 | 88849 | 430 | 93114 | 319 | 93240 | 410 |
| 84168 | 49 | 84238 | 97 | 84322 | 50 | 84974 | 69 | 88644 | 449 | 88850 | 430 | 93115 | 319 | 93241 | 410 |
| 84169 | 73 | 84240 | 43 | 84323 | 50 | 84975 | 69 | 88645 | 449 | 88851 | 422 | 93116 | 310 | 93242 | 410 |
| 84170 | 49 | 84241 | 43 | 84324 | 51 | 84976 | 69 | 88675 | 442 | 88852 | 430 | 93120 | 310 | 93243 | 410 |
| 84171 | 49 | 84242 | 43 | 84325 | 51 | 84977 | 69 | 88688 | 409 | 88853 | 430 | 93121 | 310 | 93244 | 410 |
| 84172 | 49 | 84243 | 43 | 84326 | 51 | 84978 | 69 | 88701 | 435 | 88854 | 431 | 93122 | 312 | 93245 | 410 |
| 84173 | 73 | 84245 | 45 | 84327 | 51 | 84979 | 69 | 88706 | 441 | 88855 | 413 | 93123 | 322 | 93296 | 313 |
| 84176 | 73 | 84250 | 99, 158 | 84328 | 51 | 84980 | 95 | 88707 | 441 | 88856 | 413 | 93124 | 313 | 93297 | 318 |
| 84177 | 841 | 84251 | 99, 158 | 84329 | 51 | 84981 | 95 | 88708 | 441 | 88860 | 314 | 93125 | 312 | 93298 | 318 |
| 84178 | 841 | 84252 | 99, 158 | 84330 | 51 | 85040 | 68 | 88709 | 441 | 88900 | 413 | 93126 | 320 | 93299 | 313 |
| 84179 | 841 | 84253 | 99, 158 | 84331 | 51 | 85041 | 68 | 88710 | 441 | 88901 | 413 | 93127 | 320 | 93300 | 314 |
| 84180 | 40 | 84260 | 63 | 84332 | 51 | 85042 | 68 | 88712 | 441 | 88902 | 413 | 93128 | 311 | 93301 | 312 |
| 84181 | 40 | 84261 | 63 | 84333 | 51 | 85043 | 68 | 88713 | 441 | 88903 | 413 | 93129 | 311 | 93303 | 318 |
| 84182 | 40 | 84262 | 36 | 84334 | 51 | 88008 | 442 | 88714 | 441 | 88906 | 407 | 93134 | 311 | 93304 | 318 |
| 84183 | 40 | 84263 | 36 | 84335 | 51 | 88019 | 442 | 88717 | 402 | 88907 | 407 | 93135 | 319 | 93321 | 278 |
| 84184 | 40 | 84264 | 36 | 84336 | 51 | 88020 | 442 | 88718 | 402 | 88908 | 407 | 93136 | 308 | 93400 | 317 |
| 84185 | 41 | 84265 | 36 | 84337 | 51 | 88060 | 416 | 88727 | 435 | 88909 | 407 | 93137 | 308 | 94144 | 316 |
| 84186 | 41 | 84266 | 38 | 84340 | 55 | 88061 | 416 | 88733 | 408 | 88910 | 413 | 93138 | 308, 309 | 94145 | 316 |
| 84187 | 41 | 84267 | 38 | 84341 | 55 | 88062 | 416 | 88802 | 323 | 88911 | 413 | 93139 | 308 | 94146 | 316 |
| 84188 | 41 | 84268 | 38 | 84342 | 55 | 88080 | 411 | 88803 | 323 | 88912 | 413 | 93140 | 309 | 94147 | 316 |
| 84189 | 41 | 84269 | 38 | 84343 | 55 | 88081 | 411 | 88804 | 323 | 88920 | 431 | 93142 | 317 | 94148 | 316 |
| 84190 | 40 | 84270 | 47 | 84344 | 55 | 88090 | 411 | 88805 | 323 | 88921 | 431 | 93143 | 317 | 94149 | 316 |

DE Wir behalten uns das Recht vor, die angegebenen Spezifikationen jederzeit zu ändern. Irrtum, Druckfehler und technische Änderungen vorbehalten. Artikelbeschreibungen sowie Abbildungen und Fotodarstellungen sind ohne Gewähr. Alle Angebote ohne Dekoration.

© COPYRIGHT - Die Vervielfältigung dieses Kataloges - auch wenn partial - muß ausschließlich von der Assheuer + Pott GmbH & Co. KG genehmigt werden.

GB We reserve the right to alter at any time the specifications stated without notice. Errors, printing error and technical changes reserved. Item description as well as images and illustrations are without guaranty. All offers are without decoration.

© COPYRIGHT - This catalogue may not be reproduced in whole or in part unless specific prior written authorization of Assheuer + Pott GmbH & Co. KG.

ES Las medidas indicadas son a título informativo y pueden variar sin algún previo aviso. Sin perjuicio de errores de imprenta o impresión o cambios técnicos. La descripción de los artículos, sus imágenes e ilustraciones no están sujetas a garantía. Los artículos se ofrecen sin decoración.

© COPYRIGHT - Todas reproducciones, aunque parciales, de este catálogo tienen que ser autorizadas por escrito de Assheuer + Pott GmbH & Co. KG.

PT Reservamo-nos o direito de alterar a qualquer momento as especificações publicadas sem qualquer aviso prévio. Erros, erros de impressão e alterações técnicas reservados. Descrição dos artigos, bem como imagens e ilustrações são sem garantia, todas as ofertas não incluem a decoração.

© COPYRIGHT - Este catálogo não poderá ser reproduzido em parte ou na totalidade, sem autorização prévia por escrito da Assheuer + Pott GmbH & Co. KG.

FR Nous nous réservons le droit de modifier à tout moment les spécifications techniques.

© COPYRIGHT - Toute reproduction partielle de ce catalogue est interdite sauf expressément autorisation de Assheuer + Pott GmbH & Co. KG.

Magnetfolien für Warenträger (124 x 39,5 cm, platzsparend einrollbar)
 magnetic foil for displays (124 x 39,5 cm, detachable and rolling in hood)



00470



00471

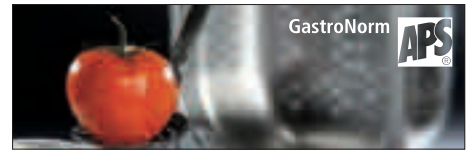

00472

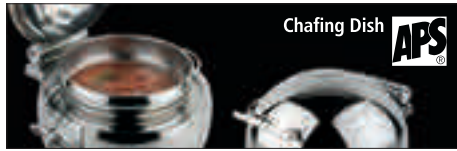

00473



00479

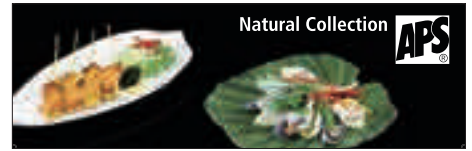

00480



00481



00483

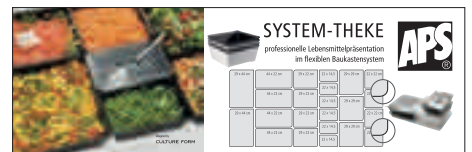

00486



00487



00490

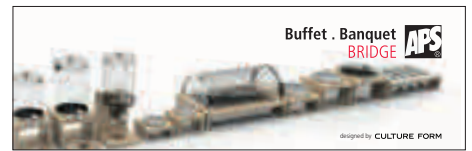

00491

freistehende L-Banner (Breite: 80 cm, Tiefe: 50 cm, Höhe: 200 cm, Gewicht: ca. 2 kg, inklusive Tragetasche, einfacher Auf- und Abbau, vielseitig einsetzbar)
 freestanding banner (width: 80 cm, depth: 50 cm, height: 200 cm, weight: approx. 2 kg including bag, easy set-up and dismantling, highly versatile)

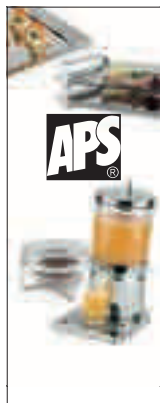

00420



00421



00422



00423



00424



00426



00427



00428



00429



00430



00422

00420

00421

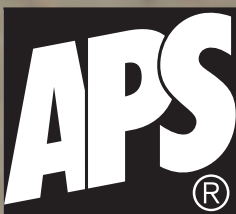

Assheuer + Pott GmbH & Co. KG
Talweg 11, 59846 Sundern, Germany

Telefon +49(0)29 33/97 35-0
Telefax +49(0)29 33/97 35-35 (Zentrale)
Telefax +49(0)29 33/97 35-34 (Export)
www.aps-germany.de
info@aps-germany.de

KATALOG NR 43
CATALOG NO 43
CATÁLOGO N° 43
CATALOGUE N° 43



€

